

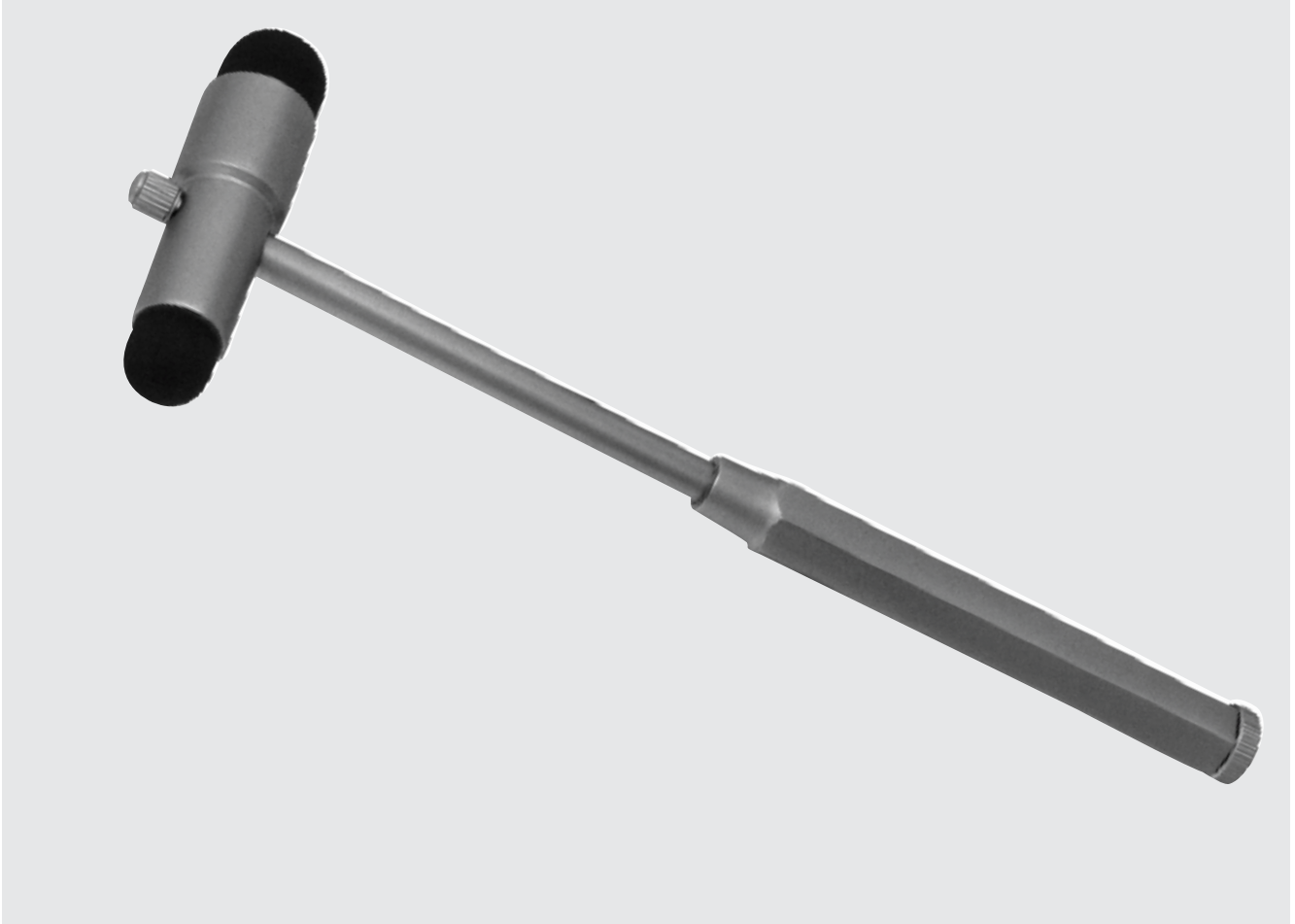

# General Surgery Instruments

**TURAB**  
**SURGICAL**  
HEALTH CARE INSTRUMENTS





Diagnostic

# Diagnostic Instruments



TS.01.01.08  
Needle Only

TS.01.01.09  
Brush Only



BUCK  
TS.01.01.18  
18 cm / 7 1/8"



Reversible Head

BABINSKI  
TS.01.04.22  
22 cm / 8 3/4"  
with needle

TS.01.05.22  
22 cm / 8 3/4"  
without needle

TS.01.04.27  
26 cm / 10 1/4"  
with needle

TS.01.05.26  
26 cm / 10 1/4"



TS.01.04.08  
Needle Only



TS.01.06.08  
Needle Only

DEJERINE  
TS.01.06.21  
21 cm / 8 1/4"



Flat Pointed  
Handle

DEJERINE  
TS.01.07.20  
20 cm / 8"



DEJERINE  
TS.01.08.20  
20 cm / 8"



TROEMNER  
TS.01.10.08  
23 cm / 9"

TS.01.10.10  
25 cm / 10"



BERLINER  
TS.01.11.10  
20 cm / 8"



TAYLOR  
TS.01.12.50  
20 cm / 8"



PINARD  
TS.01.14.10  
15 cm/ 6"



WARTENBERG  
TS.01.19.25  
18 cm/ 7 1/8"



FIMZ  
TS.01.19.55  
19 cm/ 7 1/2"



TS.01.24.02  
Head mirror only

TS.01.23.49

Ball-and-socket joint only, for headbands

TS.01.22.40

Plastic headband only, adjustable

TS.01.20.00  
ZIEGLER (COMPLETE)

# Diagnostic Instruments



JAMESON

TS.01.38.40  
10 cm / 4"  
Caliper, graduated in mm and inches



THORPE

TS.01.38.41  
11 cm / 4 1/4"  
graduated in mm and inches



TS.01.38.30  
13 cm / 5 1/8"  
Finger goniometer

graduated in cm and inches



TS.01.37.15 15 cm / 6"  
TS.01.37.20 20 cm / 8"  
TS.01.37.30 30 cm / 11 3/4"  
TS.01.37.50 50 cm / 19 3/4"  
Rules, Stainless Steel

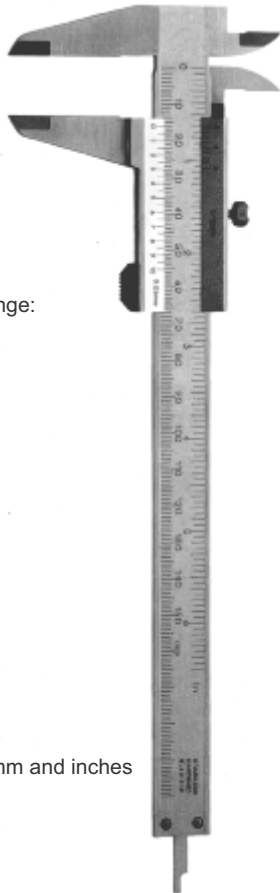

Measuring Range:  
Messbereich:

graduated in mm and inches

TS.01.38.05  
22 cm / 8 3/4"

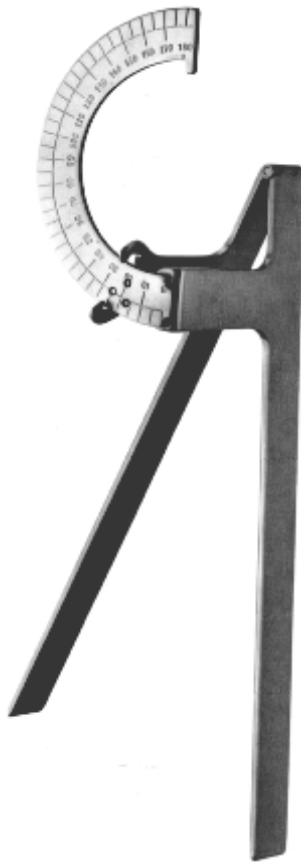

fold up  
zusammenlegbar  
plegable  
pliable  
pieghevole

Flexometer

MÖLTGEN  
TS.01.38.10  
24 cm / 9 1/2"

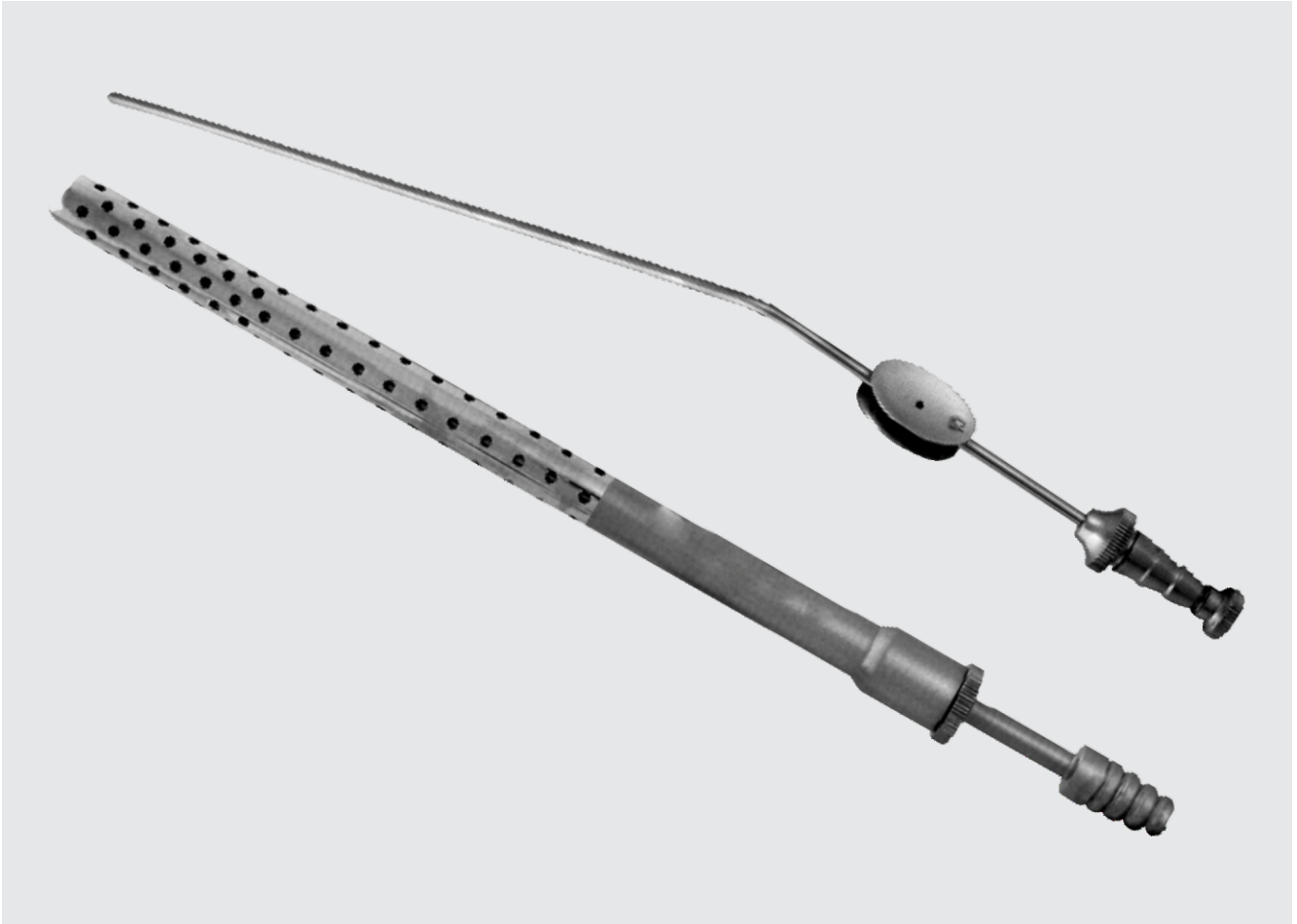

Probes . Cotton Carriers, Suction Instruments

# Probes, Cotton Carries, Suction Instruments

Ø 1.0 mm



Ø 1.5 mm



stainless steel

Ø 2 mm



stainless steel



with eye



Mod USA  
stainless steel

Ø 3 mm

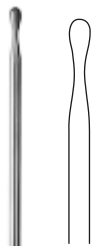

TS.01.11.14  
14.5 cm / 5¾"

TS.01.01.10 10.5 cm / 4⅛"  
TS.01.01.11 11.5 cm / 4½"  
TS.01.01.13 13 cm / 5⅞"  
TS.01.01.14 14.5 cm / 5¾"  
TS.01.01.16 16 cm / 6¼"  
TS.01.01.18 18 cm / 7⅛"  
TS.01.01.20 20 cm / 8"  
TS.01.01.25 25 cm / 10"

TS.01.02.10 10.5 cm / 4⅛"  
TS.01.02.11 11.5 cm / 4½"  
TS.01.02.13 13 cm / 5⅞"  
TS.01.02.14 14.5 cm / 5¾"  
TS.01.02.16 16 cm / 6¼"  
TS.01.02.18 18 cm / 7⅛"  
TS.01.02.20 20 cm / 8"  
TS.01.02.25 25 cm / 10"  
TS.01.02.30 30 cm / 11¾"

TS.01.04.13 13 cm / 5⅞"  
TS.01.04.14 14.5 cm / 5¾"  
TS.01.04.16 16 cm / 6¼"  
TS.01.04.20 20 cm / 8"

TS.01.05.13 13 cm / 5⅞"  
TS.01.05.14 14.5 cm / 5¾"  
TS.01.05.15 15 cm / 6"  
TS.01.05.16 16 cm / 6¼"  
TS.01.05.18 18 cm / 7⅛"  
TS.01.05.20 20 cm / 8"

TS.01.04.13 13 cm / 5⅞"  
TS.01.04.14 14.5 cm / 5¾"  
TS.01.04.16 16 cm / 6¼"  
TS.01.04.20 20 cm / 8"

TS.01.05.13 13 cm / 5⅞"  
TS.01.05.14 14.5 cm / 5¾"  
TS.01.05.15 15 cm / 6"  
TS.01.05.16 16 cm / 6¼"  
TS.01.05.18 18 cm / 7⅛"  
TS.01.05.20 20 cm / 8"

TS.01.05.13 13 cm / 5⅞"  
TS.01.05.14 14.5 cm / 5¾"  
TS.01.05.15 15 cm / 6"  
TS.01.05.16 16 cm / 6¼"  
TS.01.05.18 18 cm / 7⅛"  
TS.01.05.20 20 cm / 8"

TS.01.05.13 13 cm / 5⅞"  
TS.01.05.14 14.5 cm / 5¾"  
TS.01.05.15 15 cm / 6"  
TS.01.05.16 16 cm / 6¼"  
TS.01.05.18 18 cm / 7⅛"  
TS.01.05.20 20 cm / 8"



with eye



malleable

stainless steel



TS.01.05.21  
20 cm / 8"

TS.01.07.11 11.5 cm / 4½"  
TS.01.07.13 13 cm / 5⅞"  
TS.01.07.14 14.5 cm / 5¾"  
TS.01.07.16 16 cm / 6¼"  
TS.01.07.18 18 cm / 7⅛"  
TS.01.07.20 20 cm / 8"

TS.01.08.84  
14 cm / 5½"

TS.01.09.13 13 cm / 5⅞"  
TS.01.09.14 14.5 cm / 5¾"

NELATON  
TS.01.10.66  
16 cm / 6¼"

TS.01.12.80  
30 cm / 11¾"

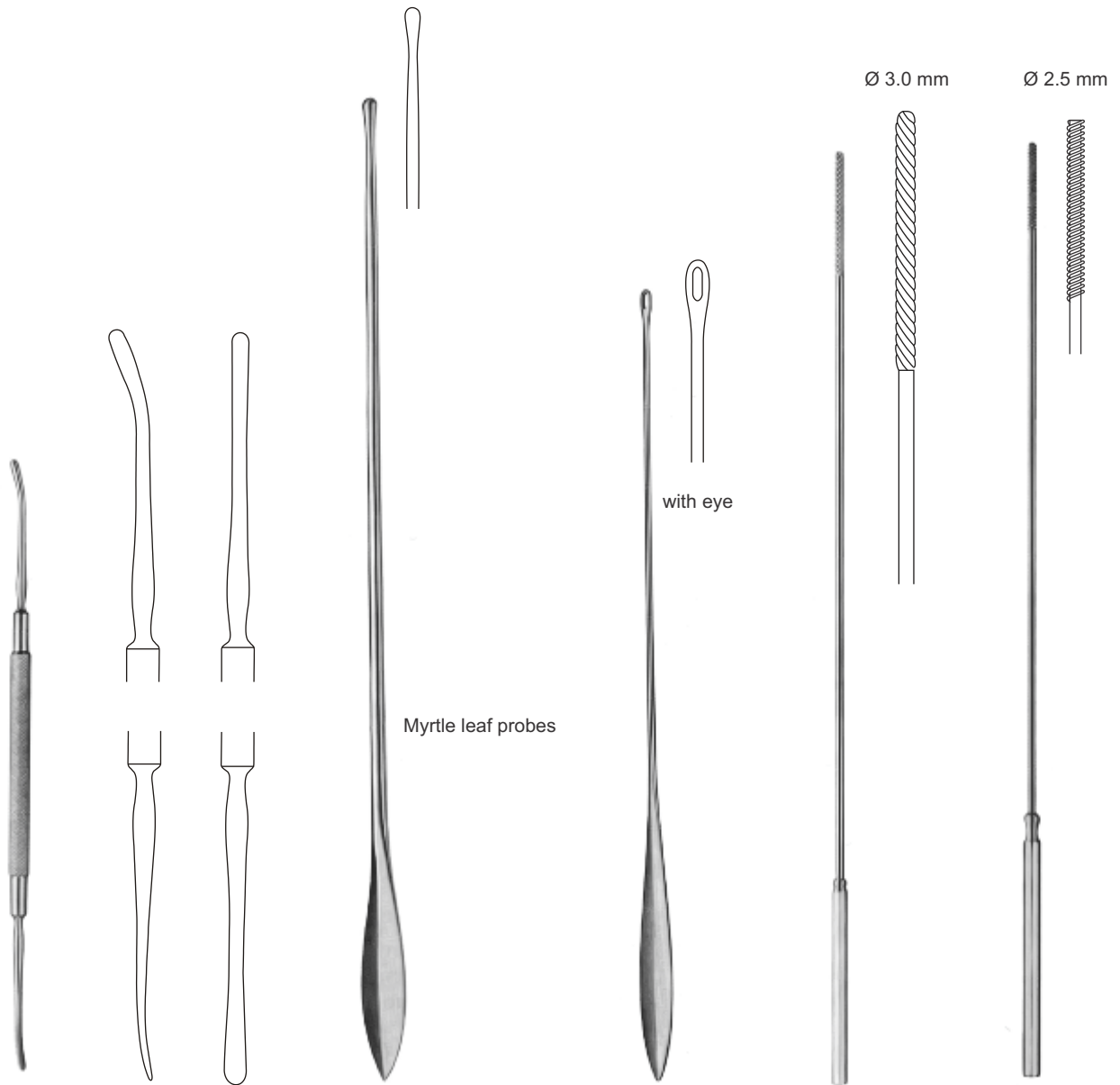

WATSON-CHEYNE  
 TS.01.10.73 13 cm/ 5<sup>1</sup>/<sub>8</sub>"  
 TS.01.10.78 18 cm/ 7<sup>1</sup>/<sub>8</sub>"

TS.01.13.13 13 cm/ 5<sup>1</sup>/<sub>8</sub>"  
 TS.01.13.14 14.5 cm/ 5<sup>3</sup>/<sub>4</sub>"  
 TS.01.13.16 16 cm/ 6<sup>1</sup>/<sub>4</sub>"  
 TS.01.13.18 18 cm/ 7<sup>1</sup>/<sub>8</sub>"  
 TS.01.13.20 20 cm/ 8"

TS.01.13.24  
 24 cm/ 9<sup>1</sup>/<sub>2</sub>"

TS.01.12.28  
 28 cm/ 11"

TS.01.13.48  
 28 cm/ 11"



# Probes, Cotton Carries, Suction Instruments

<p>Ø 1.3mm</p>	<p>Ø 1.5mm</p>	<p>Ø 1.0mm spiral threads</p>	<p>Ø 1.0mm</p>	<p>Ø 1.0mm</p>	<p>Ø 1.0mm</p>
<p>UCKERMANN TS.01.14.16 16 cm/ 6¼"</p>	<p>JOBSON-HORNE TS.01.14.18 18 cm/ 7½"</p>	<p>FROHN TS.01.16.12 12 cm/ 4¾" TS.01.16.14 14 cm/ 5½" TS.01.16.16 16 cm/ 6¼"</p>	<p>FROHN TS.01.16.22 12 cm/ 4¾" TS.01.16.24 14 cm/ 5½" TS.01.16.26 16 cm/ 6¼"</p>	<p>TS.01.16.32 12 cm/ 4¾" TS.01.16.34 14 cm/ 5½" TS.01.16.36 16 cm/ 6¼"</p>	<p>TS.01.16.32 12 cm/ 4¾" TS.01.16.34 14 cm/ 5½" TS.01.16.36 16 cm/ 6¼"</p>
<p>Ø 1.5mm</p>	<p>Ø 2.0 mm</p>	<p>Ø 1.2mm stainless steel</p>	<p>Ø 1.2mm stainless steel</p>	<p>Ø 1.2mm stainless steel</p>	<p>Ø 1.2mm stainless steel</p>
<p>FIMZ TS.01.17.12 12 cm/ 4¾" TS.01.17.14 14.5 cm/ 5¾" TS.01.17.16 16 cm/ 6¼" TS.01.17.18 18 cm/ 7½"</p>	<p>ANDREWS TS.01.18.15 15 cm/ 6" TS.01.18.18 18 cm/ 7½"</p>	<p>LATHBURY (FARRELL) TS.01.19.12 12 cm/ 4¾" TS.01.19.14 14 cm/ 5½" TS.01.19.15 15 cm/ 6" TS.01.19.16 16 cm/ 6¼" TS.01.19.18 18 cm/ 7½"</p>	<p>LATHBURY (FARRELL) TS.01.19.22 12 cm/ 4¾" TS.01.19.24 14 cm/ 5½" TS.01.19.25 15 cm/ 6" TS.01.19.26 16 cm/ 6¼" TS.01.19.28 18 cm/ 7½"</p>	<p>TS.01.19.32 12 cm/ 4¾" TS.01.19.34 14 cm/ 5½" TS.01.19.36 16 cm/ 6¼"</p>	<p>TS.01.19.32 12 cm/ 4¾" TS.01.19.34 14 cm/ 5½" TS.01.19.36 16 cm/ 6¼"</p>



Plaster spatulas

TS.01.14.23 13 cm / 5<sup>1</sup>/<sub>8</sub>"  
TS.01.14.24 14.5 cm / 5<sup>3</sup>/<sub>4</sub>"

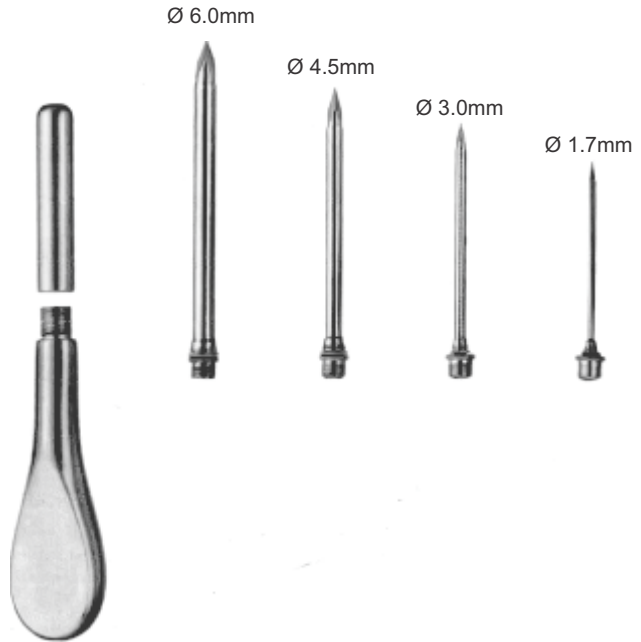

UNIVERSAL  
TS.01.21.04



Roberts

	Outer Ø		Inner Ø
	mm	Charr.	mm
TS.01.23.50	5.0	15	4.0
TS.01.23.55	5.5		4.5
TS.01.23.60	6.0	18	5.0
TS.01.23.65	6.5		5.5



NELSON

	Outer Ø		Inner Ø
	mm	charr.	mm
TS.01.24.09	3.0	9	2.2
TS.01.24.10	3.5		2.5
TS.01.24.12	4.0	12	3.0
TS.01.24.13	4.5		3.5
TS.01.24.15	5.0	15	4.0
TS.01.24.16	5.5		4.5
TS.01.24.18	6.0	18	5.0
TS.01.24.20	6.5		5.5
TS.01.24.25	8.3	25	7.3
TS.01.24.30	10.0	30	9.0
TS.01.24.35	11.7	35	10.7

# Probes, Cotton Carries, Suction Instruments



GRAEFE

	Outer Ø		Inner Ø
	mm	charr.	mm
TS.01.25.30	3.0	9	2.2
TS.01.25.40	4.0	12	3.0
TS.01.25.45	4.5		3.5
TS.01.25.50	5.0	15	4.0
TS.01.25.55	5.5		4.5
TS.01.25.60	6.0	18	5.0



OCHSNER

for catheters

	Charr.	
TS.01.26.10	10	6
TS.01.26.12	12	8
TS.01.26.14	14	10
TS.01.26.16	16	12
TS.01.26.18	18	14
TS.01.26.20	20	16
TS.01.26.22	22	18
TS.01.26.24	24	20
TS.01.26.26	26	22



14 cm / 5½"

LANDAU  
TS.01.27.02  
Ø 2 mm



Outer Ø  
8mm

Inner Ø  
7mm

10 cm - 4"

BUELAU  
TS.01.28.08  
24 cm / 9½"

FRANKLIN-SILVERMAN  
 modif. Fuchs

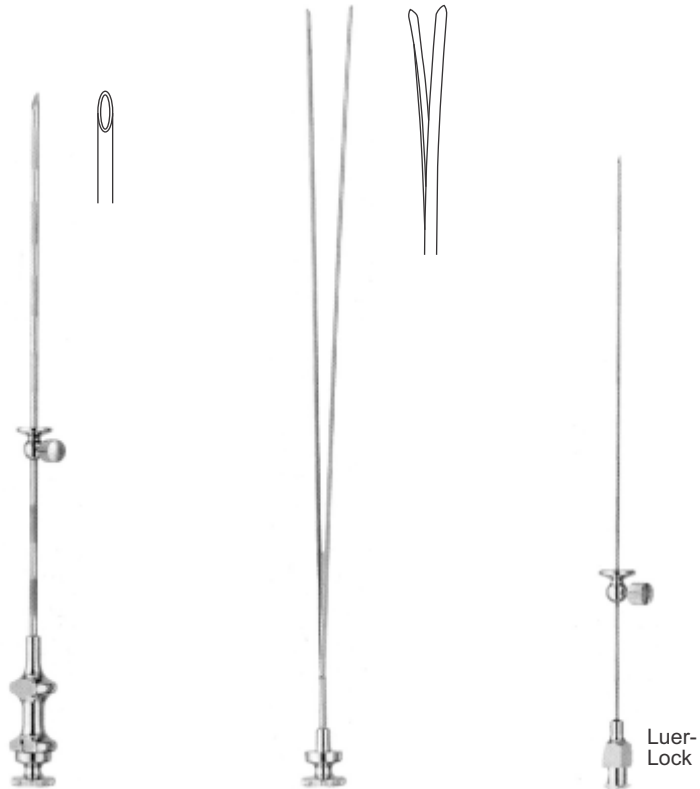

Set Complete	Biopsy cannulas	Split needles	Guide needles
TS.01.28. #1	1.60 x 50	1.00 x 100	1.00 x 100
TS.01.28. #2	1.80 x 105	1.20 x 155	1.00 x 150
TS.01.28. #3	2.00 x 105	1.50 x 155	1.00 x 150
TS.01.28. #4	2.00 x 130	1.50 x 180	1.00 x 150

# Probes, Cotton Carries, Suction Instruments



without barbs

FRANKLIN-SILVERMAN

Set Complete	Biopsy cannulas	Split needles
TS.01.28.21	2.00 x 60	1.50 x 105
TS.01.28.22	2.00 x 100	1.50 x 150
TS.01.28.23	2.50 x 145	2.00 x 195

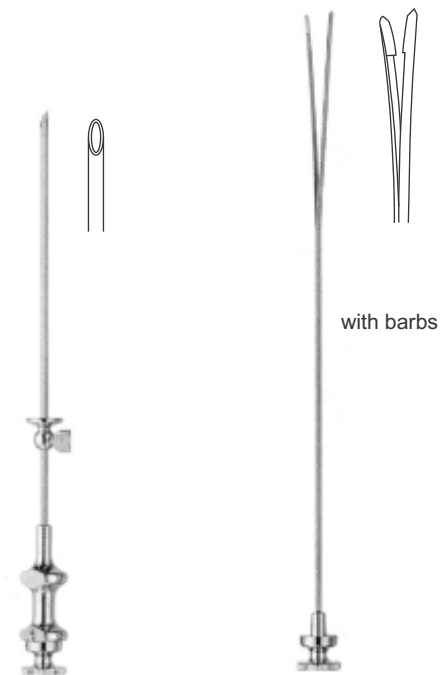

with barbs

FRANKLIN-SILVERMAN

Set Complete	Biopsy cannulas	Split needles
TS.01.28.41	2.00 x 60	1.50 x 105
TS.01.28.42	2.00 x 100	1.50 x 150
TS.01.28.43	2.50 x 145	2.00 x 195

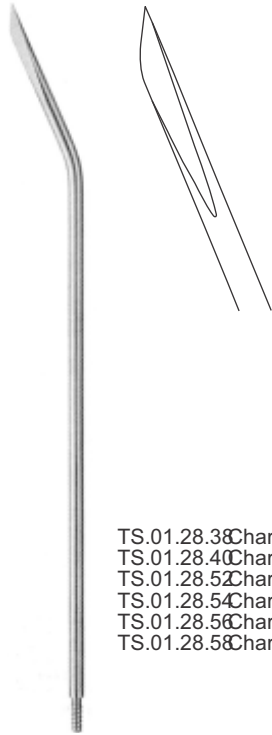

REDON

- TS.01.28.38 Charr. 8
- TS.01.28.40 Charr. 10
- TS.01.28.52 Charr. 12
- TS.01.28.54 Charr. 14
- TS.01.28.56 Charr. 16
- TS.01.28.58 Charr. 18

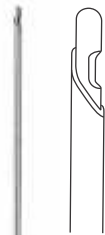

- TS.01.28.82 2.0 x 100 mm
  - TS.01.28.84 2.0 x 125 mm
- Insufflation cannulas with stopcock

Luer-Lock

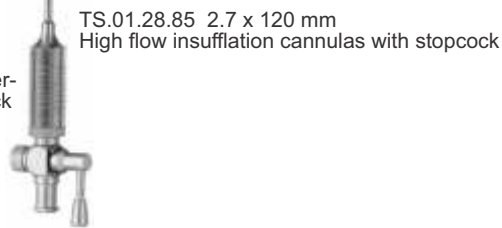

VERESS

- TS.01.28.85 2.7 x 120 mm
- High flow insufflation cannulas with stopcock



Luer-Lock

- TS.01.28.86
- 0.8 x 120 mm

Luer-Lock



- TS.01.28.88
- 3-way stopcock

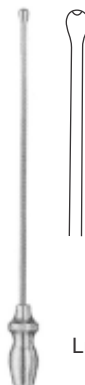

Cannulas with olive

Luer

- TS.01.28.90 1.0 x 80 mm
- TS.01.28.91 1.2 x 80 mm
- TS.01.28.92 1.4 x 80 mm
- TS.01.28.93 1.5 x 80 mm
- TS.01.28.94 1.6 x 80 mm
- TS.01.28.95 1.8 x 80 mm
- TS.01.28.96 2.0 x 80 mm

# Probes, Cotton Carries, Suction Instruments



**REDON**  
Knife edges

- TS.01.29.08 Charr. 8
- TS.01.29.10 Charr. 10
- TS.01.29.12 Charr. 12
- TS.01.29.14 Charr. 14
- TS.01.29.16 Charr. 16
- TS.01.29.18 Charr. 18

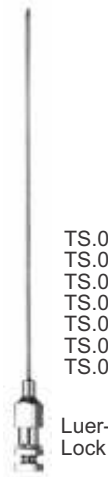

**QUINCKE**

- TS.01.29.27.70 x 80 mm
- TS.01.29.28.70 x 90 mm
- TS.01.29.30.00 x 80 mm
- TS.01.29.31.00 x 90 mm
- TS.01.29.32.20 x 90 mm
- TS.01.29.33.20 x 100 mm
- TS.01.29.34.20 x 150 mm



**TUOHY**

- TS.01.29.41.30 x 80 mm
- TS.01.29.42.50 x 80 mm
- TS.01.29.46.65 x 80 mm



**BIER**

- TS.01.29.52.20 x 80 mm
- TS.01.29.53.20 x 90 mm



**MENGHINI**

- TS.01.29.60.00 x 35 mm
- TS.01.29.61.00 x 70 mm
- TS.01.29.62.20 x 70 mm
- TS.01.29.63.20 x 100 mm
- TS.01.29.64.40 x 70 mm
- TS.01.29.65.40 x 100 mm
- TS.01.29.66.60 x 70 mm
- TS.01.29.67.80 x 80 mm
- TS.01.29.68.80 x 100 mm
- TS.01.29.69.40 x 168 mm
- TS.01.29.70.80 x 168 mm



**MENGHINI-RENALIS**

- TS.01.29.72.20 x 120 mm
- TS.01.29.74.40 x 120 mm
- TS.01.29.76.60 x 120 mm

Luer-Lock



for cannulas with Ø  
mm

- |             |      |
|-------------|------|
| TS.01.29.78 | 1.40 |
| TS.01.29.80 | 1.80 |



YANKAUER  
TS.01.30.00  
28 cm/ 11"



TS.01.30.01  
Suction tip only



TS.01.30.19  
Tubing connector only for TS.01.30.00



YANKAUER  
TS.01.30.12  
32 cm/ 12½"



TS.01.30.19



# Probes, Cotton Carries, Suction Instruments

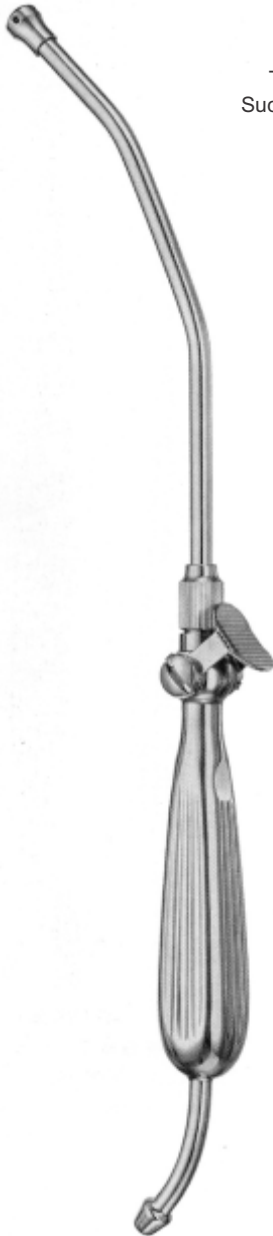

  
TS.01.31.15  
Suction tip only



  
TS.01.32.17  
Suction tip only

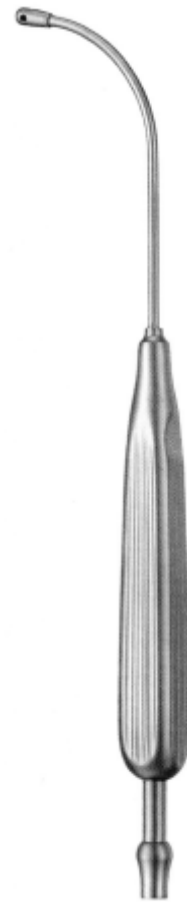

ANDREWS-PYNCHON  
TS.01.33.08  
24 cm/ 9½"

YANKAUER  
TS.01.31.06  
33 cm/ 13"

DEBAKEY  
TS.01.32.07  
29 cm/ 11"

Cut-off valve

Ø 8 mm

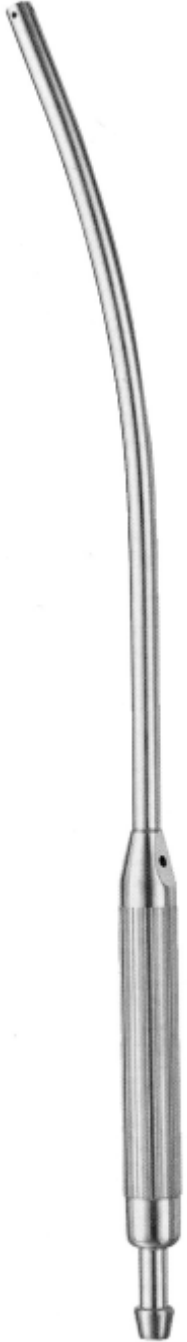

COOLEY  
TS.01.33.10  
36 cm/ 14"

Ø 8 mm



COOLEY  
TS.01.33.15  
30 cm/ 11¾"

Ø 9 mm



COOLEY  
TS.01.33.16  
30 cm/ 11¾"

Ø 8 mm



COOLEY  
TS.01.33.20  
33 cm/ 13"

13 cm - 5 1/8"  
Ø 9 mm



COOLEY  
TS.01.33.25  
25 cm/ 10"

# Probes, Cotton Carries, Suction Instruments



POOLE  
TS.01.34.18  
20 cm/ 8"  
Charr. 16.5 Ø 5.5 mm

TS.01.34.30  
23 cm/ 9"  
Charr. 30 Ø 10.0 mm



POOLE  
TS.01.35.18  
20 cm/ 8"  
Charr. 16.5 Ø 5.5 mm

TS.01.35.23  
23 cm/ 9"  
Charr. 23 Ø 8.0 mm



TS.01.35.30 Ø 6 mm  
21 cm/ 8¼"

TS.01.35.30 Ø 6 mm  
28 cm/ 11"

Working length 12.5 cm



FRAZIER

Working length 12.5 cm

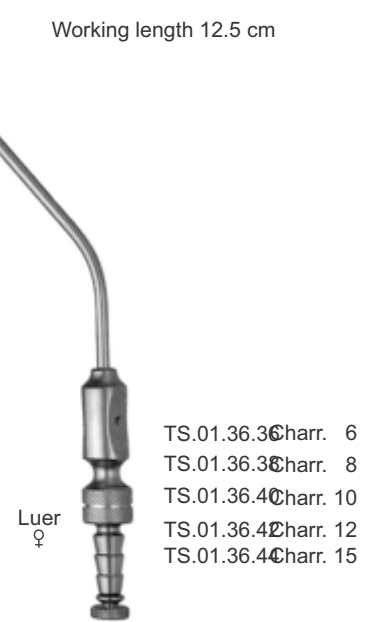

FRAZIER (FERGUSSON)

Working length 18cm



FRAZIER

Working length 18cm



FRAZIER (FERGUSSON)

# Probes, Cotton Carries, Suction Instruments

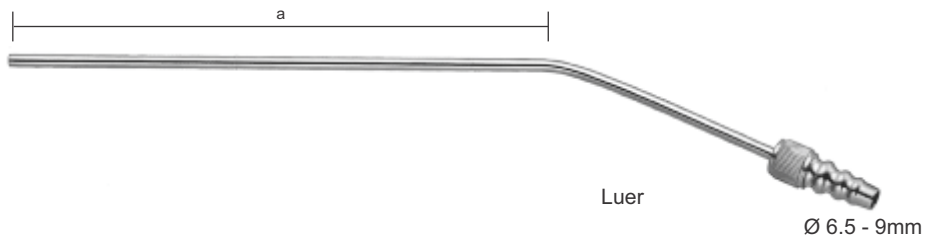
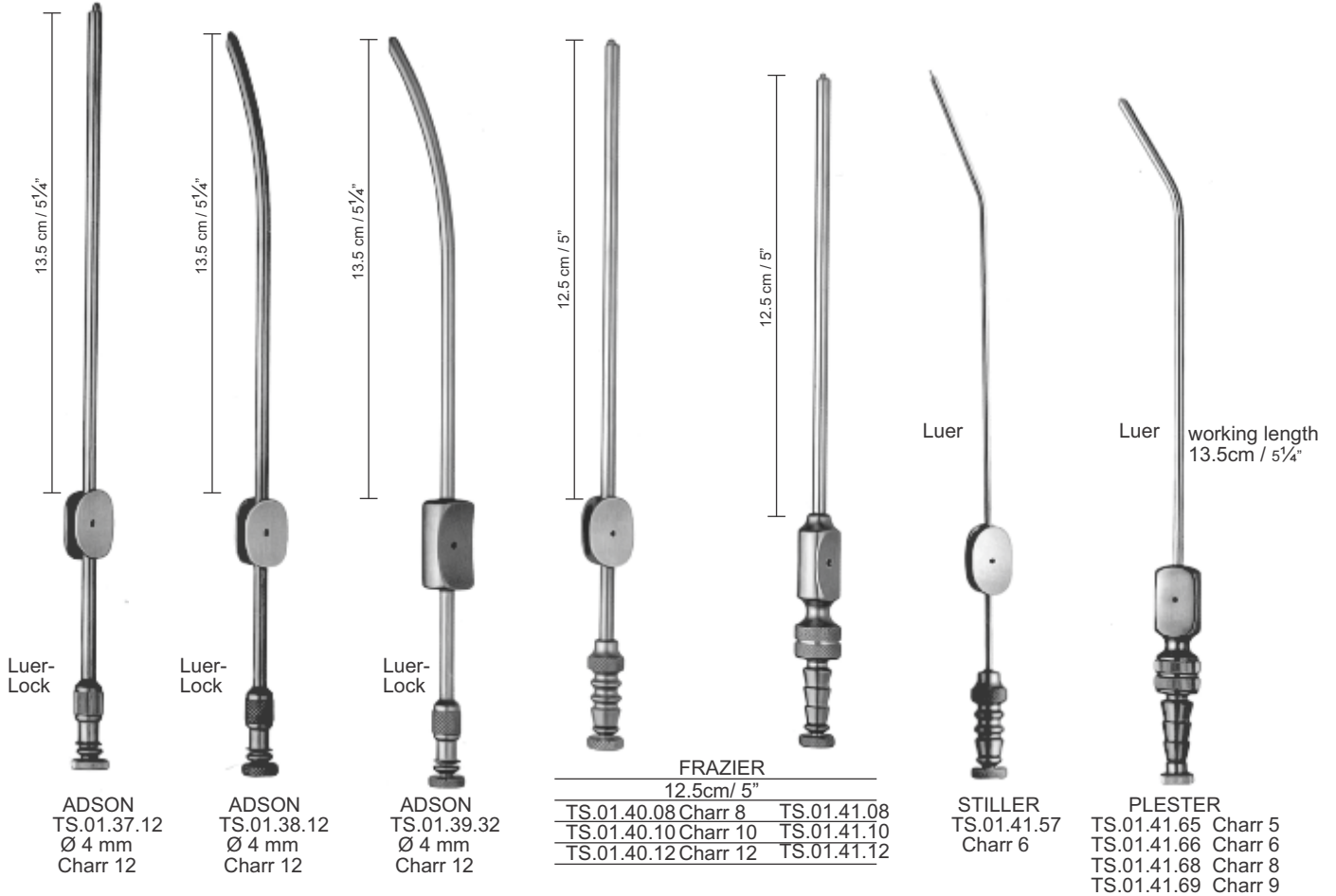

## YASARGIL

	Ø 1.5 mm	Ø 2 mm	Ø 2.5 mm	Ø 3.5 mm	Ø 4.5 mm
a = 13 cm - 5 1/8"	TS.01.41.13	TS.01.41.23	TS.01.41.33	TS.01.41.43	
a = 15 cm - 6"	TS.01.41.15	TS.01.41.25	TS.01.41.35	TS.01.41.45	
a = 18 cm - 7 1/8"	TS.01.41.18	TS.01.41.28	TS.01.41.38	TS.01.41.48	TS.01.41.58
a = 22 cm - 8 3/4"	TS.01.41.22	TS.01.41.32	TS.01.41.42	TS.01.41.52	

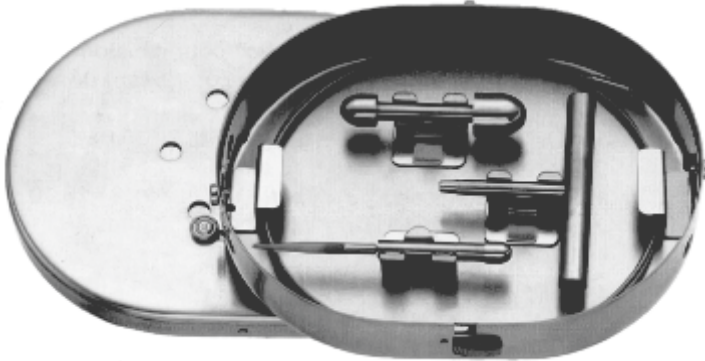

NABATOFF  
TS.01.42.00  
Varicose vein probe set complete in metal case



TS.01.43.11  
90cm / 35 3/8"  
Traction cable

TS.01.43.19  
Metal case only



TS.01.44.12  
Handle



TS.01.45.16  
Plastic probe tip



TS.01.46.18  
Metal probe tip



TS.01.47.26  
Ø 6 mm



TS.01.48.29  
Ø 9 mm



TS.01.49.32  
Ø 12 mm











TS.01.50.35  
Ø 15 mm

Olives

# Probes, Cotton Carries, Suction Instruments

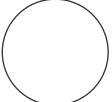

55cm/ 21¾"

- |   |   |   |   |   |
|---|---|---|---|---|
|  |  |  |  |  |
| TS.01.51.02<br>Ø 2 mm   | TS.01.52.03<br>Ø 3 mm   | TS.01.53.04<br>Ø 4 mm   | TS.01.54.06<br>Ø 6 mm   | TS.01.55.07<br>Ø 7 mm   |
|  |  |  |  |   |
| TS.01.56.08<br>Ø 8.5 mm   | TS.01.57.10<br>Ø 10 mm  | TS.01.58.12<br>Ø 12 mm  | TS.01.59.14<br>Ø 14 mm  |   |



TS.01.60.19  
12 cm/ 4¾"

Handle for endarterectomy strippers

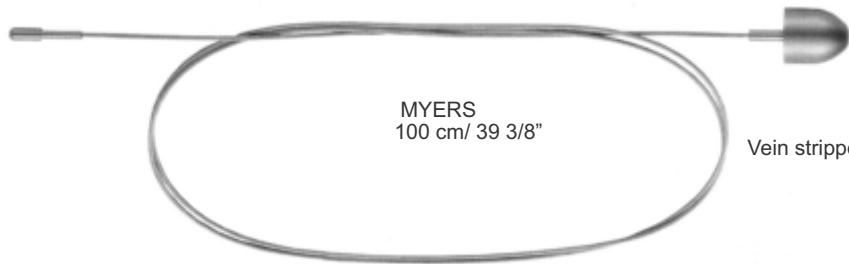

MYERS  
100 cm/ 39 3/8"

Vein strippers



TS.01.61.56  
Ø 6 mm



TS.01.61.59  
Ø 9 mm





TS.01.61.62  
Ø 12 mm



TS.01.61.65  
Ø 15 mm

MYERS

**Probes, Cotton Carries, Suction Instruments**

		
TS.01.73.48 4.8 mm	TS.01.73.72 7.2 mm	TS.01.73.96 9.6 mm
MAYO Inner Ø		



malleable

SCHMID  
15 cm / 6"



TS.01.75.03  
Ø 3 mm



TS.01.75.04  
Ø 4 mm



TS.01.75.05  
Ø 5 mm



TS.01.75.06  
Ø 6 mm

Vascular irrigation cannulas



MAYO  
39 cm / 15½"



# Probes, Cotton Carries, Suction Instruments



SCHMID

Vascular spatulas

5 mm



TS.01.77.15  
14 cm / 5½"

7 mm



TS.01.77.17  
24 cm / 9½"

Ø 6 mm

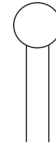

Varicose vein probes

malleable

TS.01.76.040 cm / 16"  
TS.01.76.050 cm / 20"  
TS.01.76.065 cm /  
TS.01.76.080 cm / 32"

BABCOCK



Scissors

# SCISSORS

**NZS** Supercut scissors with their uniquely ground edges have with ultimate cutting efficiency. The special micro serrations in conjunction with the uniquely ground edges ensure precise, fine and minimally traumatising cuts.

**NZS** scissors have fully gold-coloured screw for ease of identification.

The range of supercut scissors from **NZS** comprises all models used routinely by surgeons: scissors for delicate and extremely delicate dissecting, e.g. Iris and Micro, models according to Metzenbaum in all possible lengths and design e.g. in a slim version for especially fine cutting to name but a few.

The supercut scissors can also be supplied with "TC" welded cutting edges of solid tungsten carbide alloy. The junction between the steel of the scissors and the tungsten carbide is seamless and homogenous. The welded cutting edges of solid tungsten carbide alloy guarantee excellent cutting quality and long life-span.

## Identification:

**NZS** TC scissors:  
gold-coloured rings



**NZS** supercut scissors:  
Black quoted shafts



**NZS** supercut plus line scissors:  
one shaft gold plated and  
one shaft black quoted



# SCISSORS



IRIS

	straight	curved	straight	curved	straight	curved	straight	curved
	9 cm/ 3½"		10.5 cm/ 4¼"		11.5 cm/ 4½"		12.5 cm/ 5"	
standard	TS.01.01.09	TS.01.02.09	TS.01.01.10	TS.01.02.10	TS.01.01.11	TS.01.02.11	TS.01.01.12	TS.01.02.12
"TC"					TS.01.05.61	TS.01.06.61		
supercut			TS.01.01.11	TS.01.02.11	TS.01.01.11	TS.01.02.11		TS.01.02.21
supercut plus					TS.01.05.16	TS.01.06.16		
black line	TS.01.01.21	TS.01.02.21	TS.01.01.21	TS.01.02.21	TS.01.01.21	TS.01.02.21		



MICRO IRIS  
9 cm/ 3½"

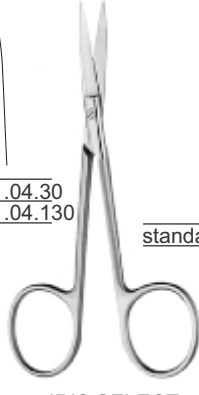

IRIS SELECT  
10.5 cm/ 4¼"

standard	TS.01.03.30	TS.01.04.30
supercut	TS.01.03.130	TS.01.04.130

standard	TS.01.03.40	TS.01.04.40
----------	-------------	-------------



11.5 cm/ 4½"

standard TS.01.03.71 TS.01.04.71



standard TS.01.07.10 TS.01.08.10 TS.01.07.12 TS.01.08.12

10.5 cm/ 4¼" 12 cm/ 4¾"

# SCISSORS

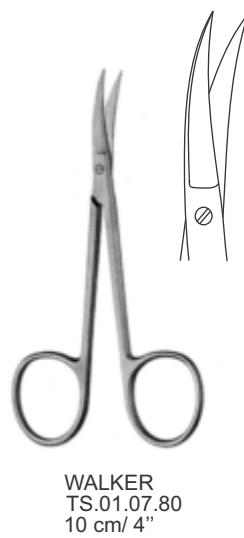
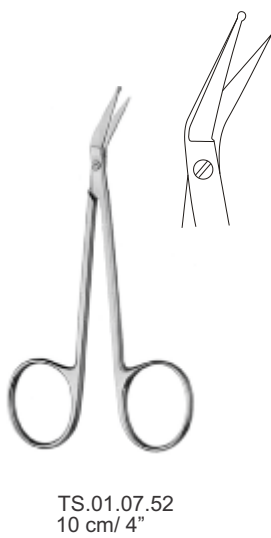
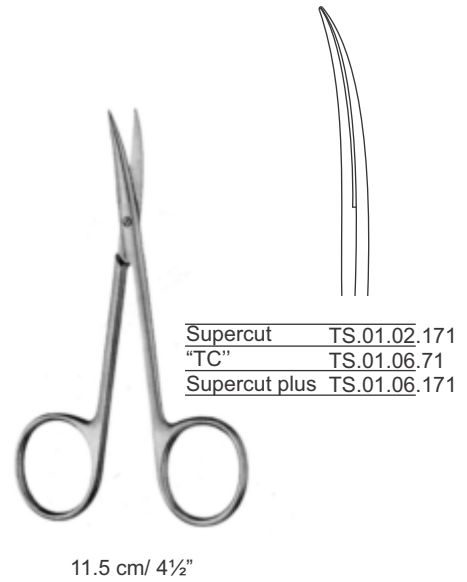

**SCISSORS**

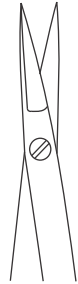

TS.01.07.109  
 9.5 cm/ 3¾"

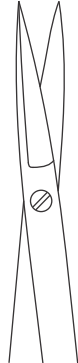

TS.01.07.110  
 10.5 cm/ 4¼"



TS.01.08.109  
 9.5 cm - 3¾"



TS.01.08.110  
 10.5 cm/ 4¼"



BEUSE

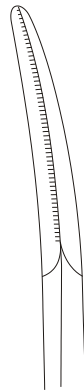
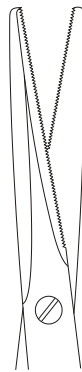
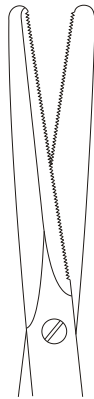

standard TS.01.08.14 TS.01.09.14 TS.01.08.18 TS.01.09.18  
 14 cm/ 5½" 18 cm/ 7¼"

# SCISSORS

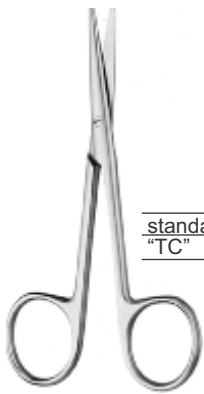

LEXER BY  
10 cm/4"



standard	TS.01.11.10	TS.01.12.10
"TC"	TS.01.13.60	TS.01.13.61

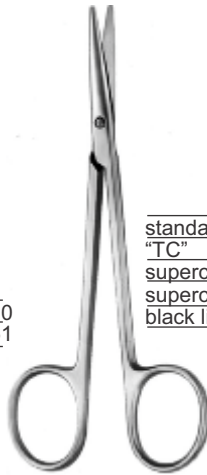

KNAPP  
12.5cm / 5"

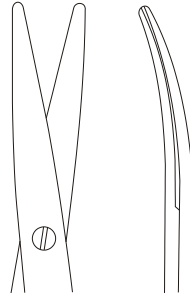

standard	TS.01.11.12	TS.01.12.12
"TC"	TS.01.13.62	TS.01.13.63
supercut	TS.01.11.112	TS.01.12.112
supercut plus	TS.01.13.162	TS.01.13.163
black line	TS.01.11.212	TS.01.12.212



CHADWICK  
TS.01.12.41  
11.5 cm/ 4½"

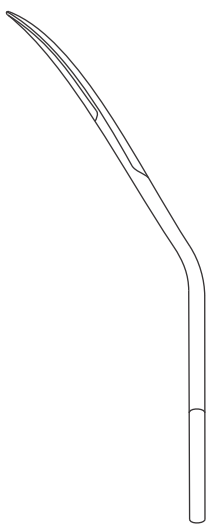

NIRO  
TS.01.119.14  
14 cm/ 5½"



LAGRANGE  
TS.01.120.14  
14 cm/ 5½"



**SCISSORS**

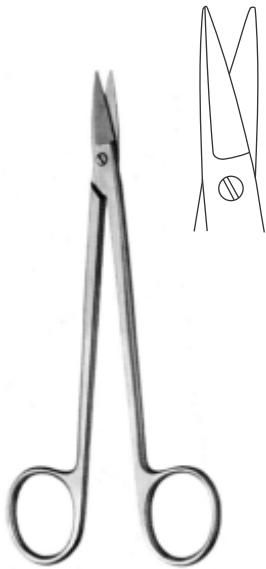

QUIMBY  
 TS.01.110.13  
 13 cm/ 5 1/8"



QUIMBY  
 TS.01.111.13  
 13 cm/ 5 1/8"



LOCKLIN  
 16 cm/ 6 1/4"

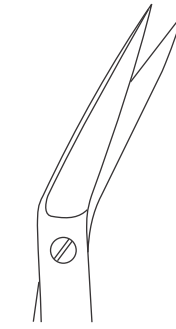

TS.01.115.15

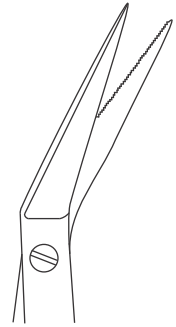

TS.01.115.16  
 serrated cutting edges

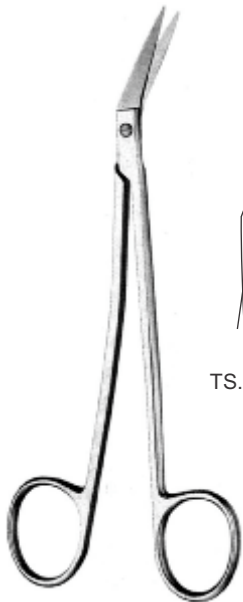

LOCKLIN  
 16 cm/ 6 1/4"

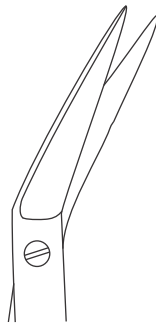

TS.01.116.26

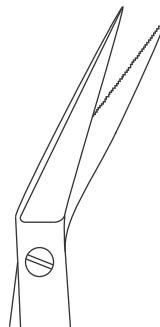

TS.01.116.27  
 serrated cutting edges



SISTRUNK  
 TS.01.118.04  
 14 cm/ 5 1/2"





# SCISSORS



TS.01.08.91  
TS.01.08.92 "TC"  
11.5 cm/4½"



TS.01.09.02 TS.01.09.03  
**STEVENS**  
11.5 cm/4½"



TS.01.09.52  
11.5 cm/4½"

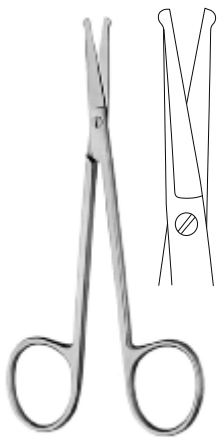

TS.01.09.62  
10.5 cm/ 4¼"

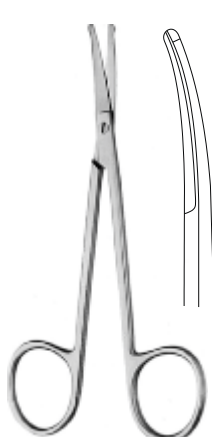

TS.01.09.63  
10.5 cm/ 4¼"



TS.01.09.65  
10.5 cm/ 4¼"

**SCISSORS**

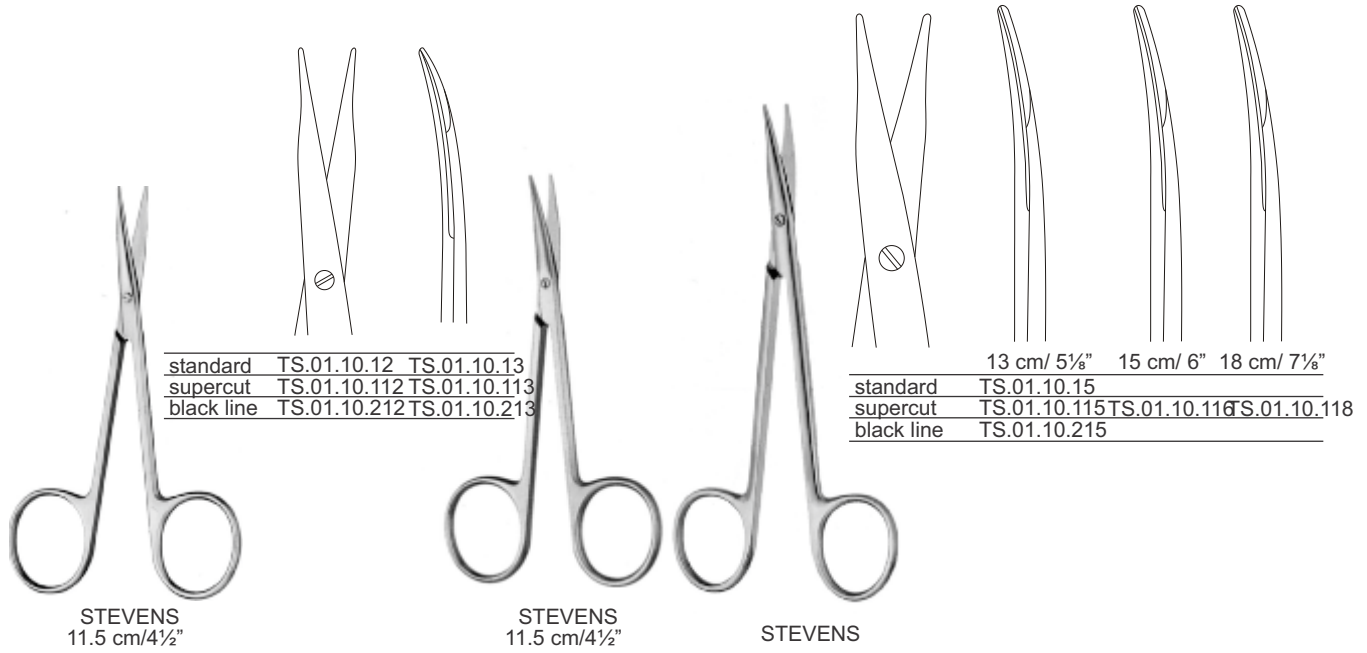
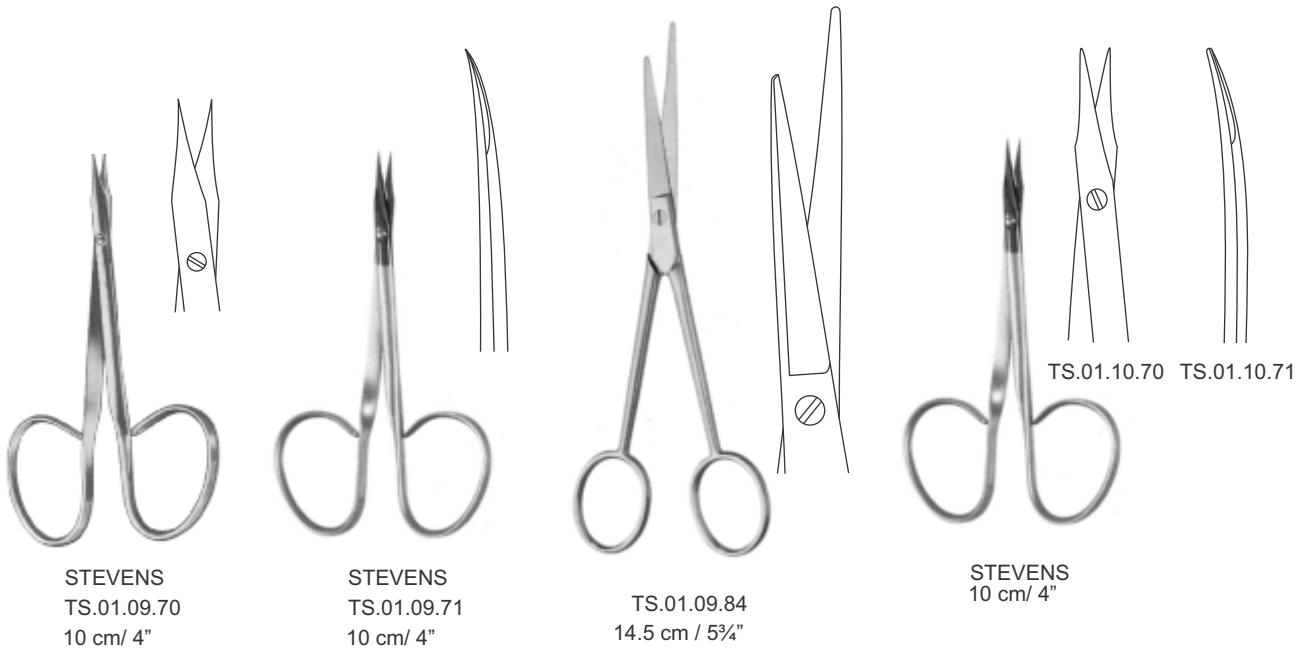

# SCISSORS

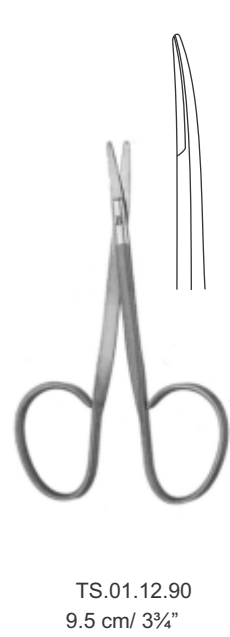
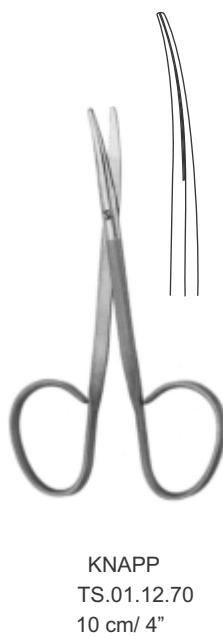
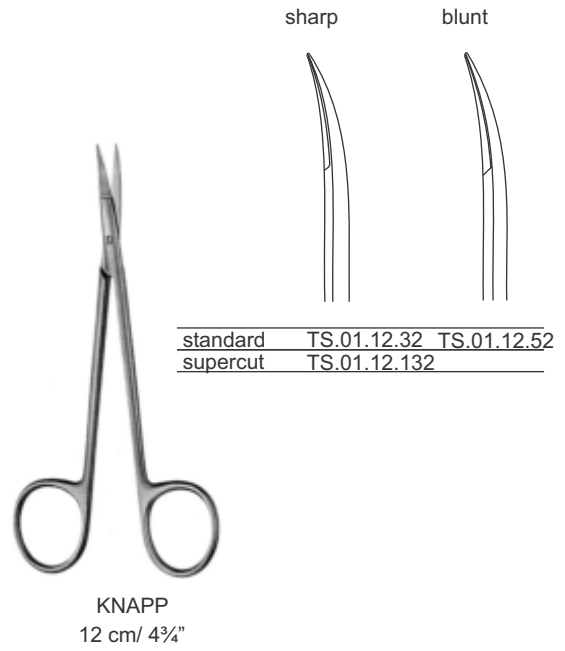
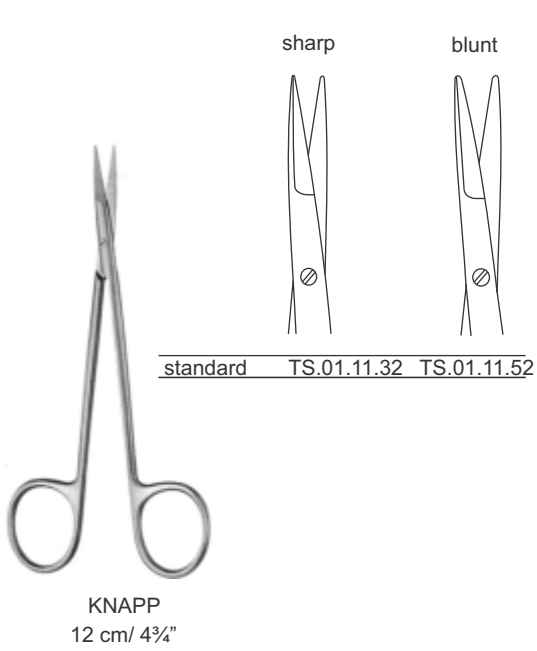

# SCISSORS

## blunt/blunt

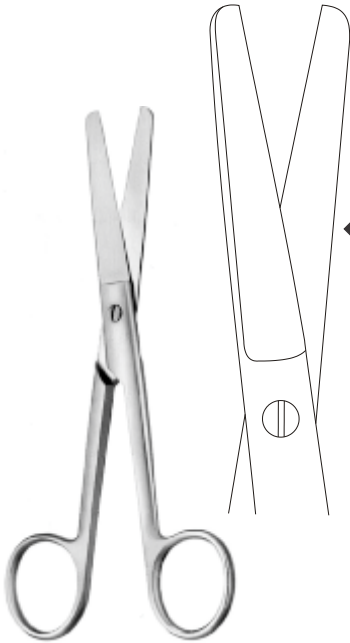

straight

	straight	straight	straight	straight
	10.5 cm/ 4 $\frac{1}{8}$ "	11.5 cm/ 4 $\frac{1}{2}$ "	13 cm/ 5 $\frac{1}{8}$ "	14.5 cm/ 5 $\frac{3}{4}$ "
standard	TS.01.14.10	TS.01.14.11	TS.01.14.13	TS.01.14.14
"TC"				TS.01.14.64
supercut			TS.01.14.113	TS.01.14.114
black line				TS.01.14.214

	15 cm/ 6"	16.5 cm/ 6 $\frac{1}{2}$ "	17.5 cm/ 7"	18.5 cm/ 7 $\frac{1}{4}$ "
standard	TS.01.14.15	TS.01.14.16	TS.01.14.17	TS.01.14.18

	20cm/ 8"
standard	TS.01.14.20

	curved	curved	curved	curved
	10.5 cm/ 4 $\frac{1}{8}$ "	11.5 cm/ 4 $\frac{1}{2}$ "	13 cm/ 5 $\frac{1}{8}$ "	14.5 cm/ 5 $\frac{3}{4}$ "
standard	TS.01.18.10	TS.01.18.11	TS.01.18.13	TS.01.18.14
"TC"				TS.01.18.64
supercut			TS.01.18.113	TS.01.18.114
black line				TS.01.18.214

	15 cm/ 6"	16.5 cm/ 6 $\frac{1}{2}$ "	17.5 cm/ 7"	18.5cm/ 7 $\frac{1}{4}$ "
standard	TS.01.18.15	TS.01.18.16	TS.01.18.17	TS.01.18.18

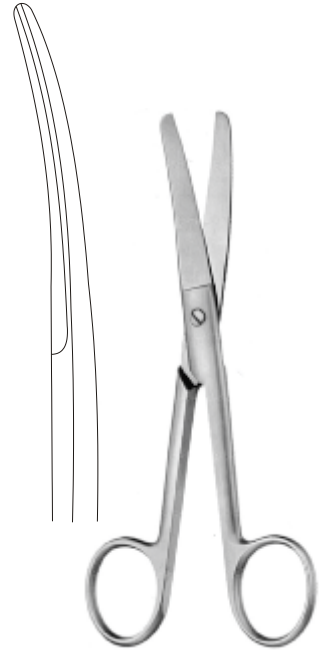

curved

## sharp/sharp

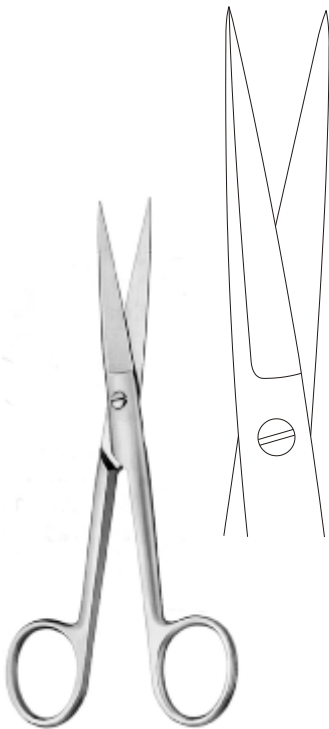

straight

	straight	straight	straight	straight
	10.5 cm/ 4 $\frac{1}{8}$ "	11.5 cm/ 4 $\frac{1}{2}$ "	13 cm/ 5 $\frac{1}{8}$ "	14.5 cm/ 5 $\frac{3}{4}$ "
standard	TS.01.15.10	TS.01.15.11	TS.01.15.13	TS.01.15.14
"TC"				TS.01.15.64
supercut			TS.01.15.113	TS.01.15.114
black line				TS.01.15.214

	15 cm/ 6"	16.5 cm/ 6 $\frac{1}{2}$ "	17.5 cm/ 7"	18.5 cm/ 7 $\frac{1}{4}$ "
standard	TS.01.15.15	TS.01.15.16	TS.01.15.17	TS.01.15.18

	curved	curved	curved	curved
	10.5 cm/ 4 $\frac{1}{8}$ "	11.5 cm/ 4 $\frac{1}{2}$ "	13 cm/ 5 $\frac{1}{8}$ "	14.5 cm/ 5 $\frac{3}{4}$ "
standard	TS.01.19.10	TS.01.19.11	TS.01.19.13	TS.01.19.14
"TC"				TS.01.19.64
supercut			TS.01.19.113	TS.01.19.114
black line				TS.01.19.214

	15 cm/ 6"	16.5cm/ 6 $\frac{1}{2}$ "	17.5 cm/ 7"	18.5 cm/ 7 $\frac{1}{4}$ "
standard	TS.01.19.15	TS.01.19.16	TS.01.19.17	TS.01.19.18



curved

# SCISSORS

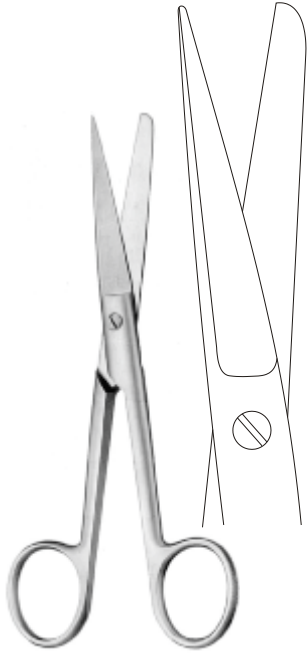

straight

sharp/blunt

	straight	straight	straight	straight
	10.5 cm/ 4 $\frac{1}{8}$ "	11.5 cm/ 4 $\frac{1}{2}$ "	13 cm/ 5 $\frac{1}{8}$ "	14.5 cm/ 5 $\frac{3}{4}$ "
standard	TS.01.16.10	TS.01.16.11	TS.01.16.13	TS.01.16.14
"TC"				TS.01.16.64
supercut			TS.01.16.113	TS.01.16.114
black line				TS.01.16.214

	15 cm/ 6"	16.5 cm/ 6 $\frac{1}{2}$ "	17.5 cm/ 7"	18.5 cm/ 7 $\frac{1}{4}$ "
standard	TS.01.16.15	TS.01.16.16	TS.01.16.17	TS.01.16.18
	20 cm/ 8"			
standard	TS.01.16.20			

	curved	curved	curved	curved
	10.5 cm/ 4 $\frac{1}{8}$ "	11.5 cm/ 4 $\frac{1}{2}$ "	13 cm/ 5 $\frac{1}{8}$ "	14.5 cm/ 5 $\frac{3}{4}$ "
standard	TS.01.17.10	TS.01.17.11	TS.01.17.13	TS.01.17.14
"TC"				TS.01.17.64
supercut			TS.01.17.113	TS.01.17.114
black line				TS.01.17.214

	15 cm/ 6"	16.5 cm/ 6 $\frac{1}{2}$ "	17.5 cm/ 7"	18.5 cm/ 7 $\frac{1}{4}$ "
standard	TS.01.17.15	TS.01.17.16	TS.01.17.17	TS.01.17.18
	20 cm/ 8"			
standard	TS.01.17.20			

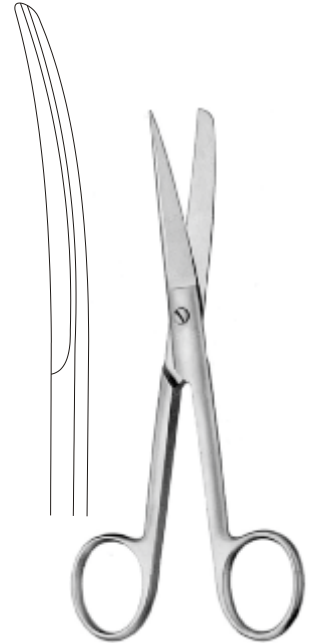

curved

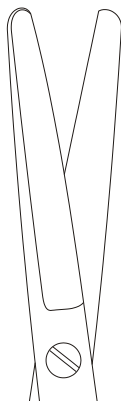

straight  
TS.01.14.83  
13 cm/ 5 $\frac{1}{8}$ "

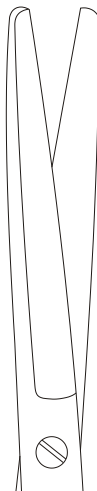

straight  
TS.01.14.84  
14.5 cm/ 5 $\frac{3}{4}$ "



curved  
TS.01.18.83  
13 cm/ 5 $\frac{1}{8}$ "



curved  
TS.01.18.84  
14.5 cm/ 5 $\frac{3}{4}$ "

**SCISSORS**

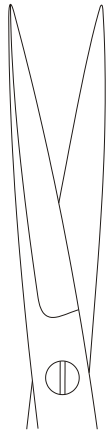

straight  
 TS.01.15.83  
 13 cm/ 5½"



straight  
 TS.01.15.84  
 14.5 cm/ 5¾"



curved  
 TS.01.19.83  
 13 cm/ 5½"



curved  
 TS.01.19.84  
 14.5 cm/ 5¾"

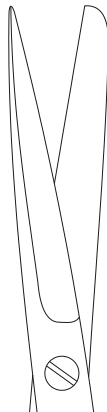

straight  
 TS.01.16.83  
 13 cm/ 5½"

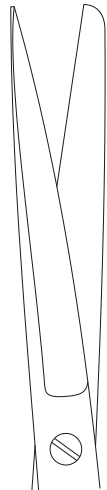

straight  
 TS.01.16.84  
 14.5 cm/ 5¾"



curved  
 TS.01.17.83  
 13 cm/ 5½"

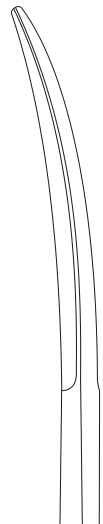

curved  
 TS.01.17.84  
 14.5 cm/ 5¾"

# SCISSORS

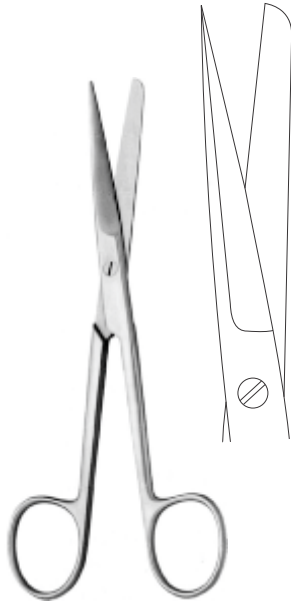

DEAVER  
TS.01.20.14  
14 cm/ 5½"



DEAVER  
TS.01.21.14  
14 cm/ 5½"



DEAVER  
TS.01.21.34  
14 cm/ 5½"

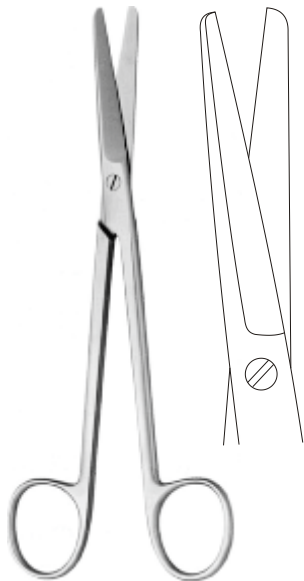

MIXTER  
TS.01.22.55  
15.5 cm/ 6¼"



MIXTER  
TS.01.23.55  
15.5 cm/ 6¼"

**SCISSORS**



**DOYEN**  
 18 cm / 7 1/8"



straight curved

standard	TS.01.22.18	TS.01.23.18
supercut	TS.01.22.118	TS.01.23.118
black line	TS.01.22.218	TS.01.23.218



**WERTHEIM**

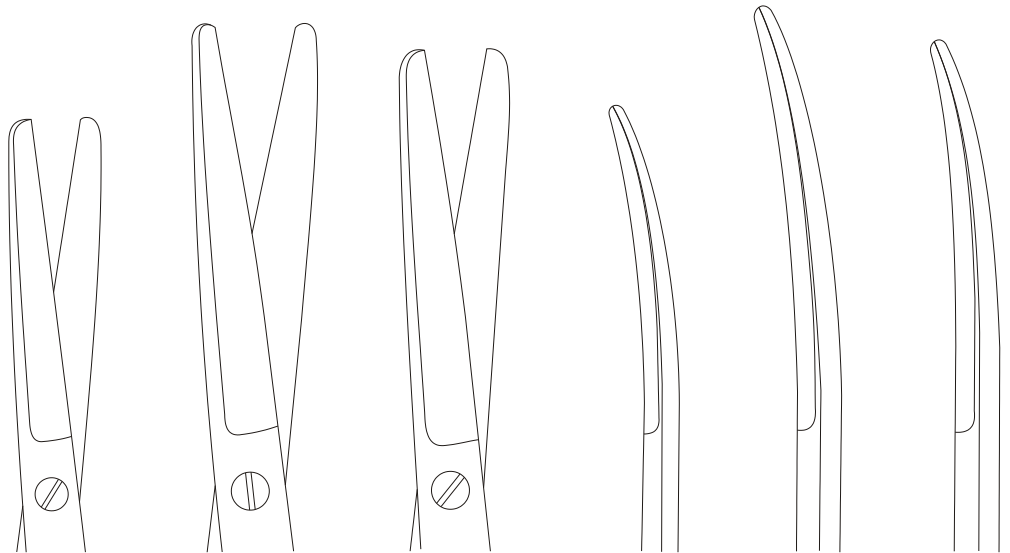

straight	straight	straight	curved	curved	curved
TS.01.22.24	TS.01.22.30	TS.01.22.33	TS.01.23.24	TS.01.23.30	TS.01.23.33
14.5 cm / 5 3/4"	20 cm / 8"	23 cm / 9"	14.5 cm / 5 3/4"	20 cm / 8"	23 cm / 9"



# SCISSORS

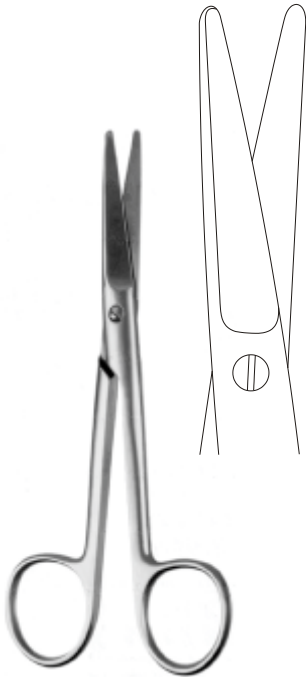

MAYO  
straight

	straight	straight	straight	straight
	14 cm/ 5½"	15.5 cm/ 6⅛"	17 cm/ 6¾"	23 cm/ 9"
standard	TS.01.24.14	TS.01.24.15	TS.01.24.17	TS.01.24.23
"TC"	TS.01.24.64	TS.01.24.65	TS.01.24.67	TS.01.24.73
supercut	TS.01.24.114	TS.01.24.115	TS.01.24.117	TS.01.24.123
supercut plus	TS.01.24.164	TS.01.24.165	TS.01.24.167	TS.01.24.173
black line	TS.01.24.214		TS.01.24.217	TS.01.24.223

	curved	curved	curved	curved
	14 cm/ 5½"	15.5 cm/ 6⅛"	17 cm/ 6¾"	23 cm/ 9"
standard	TS.01.25.14	TS.01.25.15	TS.01.25.17	TS.01.25.23
"TC"	TS.01.25.64	TS.01.25.65	TS.01.25.67	TS.01.25.73
supercut	TS.01.25.114	TS.01.25.115	TS.01.25.117	TS.01.25.123
supercut plus	TS.01.25.164	TS.01.25.165	TS.01.25.167	TS.01.25.173
black line	TS.01.25.214		TS.01.25.217	TS.01.25.223



MAYO  
curved



MAYO-HARRINGTON  
straight

	straight	straight	curved	curved
	20cm/ 8"	23cm/ 9"	20cm/ 8"	23cm/ 9"
standard	TS.01.24.80	TS.01.24.83	TS.01.25.80	TS.01.25.83
"TC"	TS.01.24.81	TS.01.24.84	TS.01.25.81	TS.01.25.84



MAYO-HARRINGTON  
curved

**SCISSORS**



SIMS

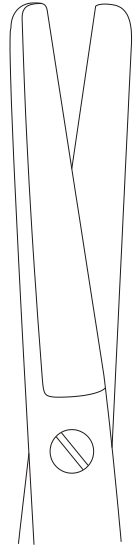

20cm/ 8"      23cm/ 9"

standard	TS.01.26.20	TS.01.26.23
supercut	TS.01.26.120	

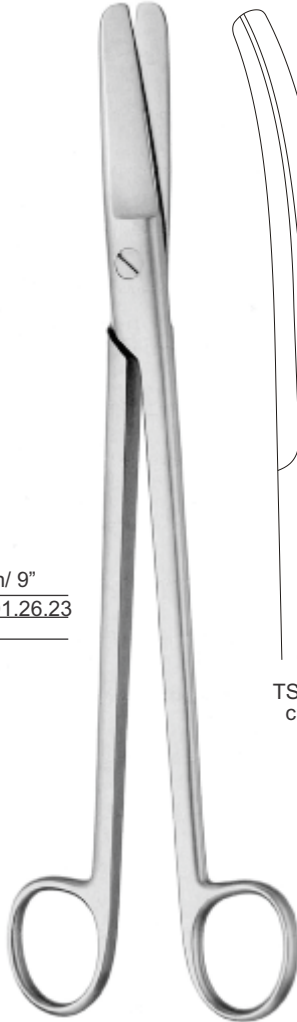

DUBOIS  
TS.01.26.27  
27 cm/ 10¾"  
straight



TS.01.26.47  
curved



SIMS

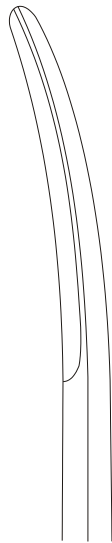

	20cm/ 8"	23cm/ 9"
standard	TS.01.27.20	TS.01.27.23
"TC"	TS.01.27.50	
supercut	TS.01.27.120	TS.01.27.123
supercut plus	TS.01.27.150	
black line	TS.01.27.220	TS.01.27.223



SIMS

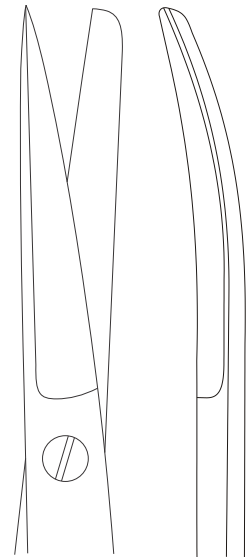

	20cm/ 8"	23cm/ 9"
straight	TS.01.26.40	TS.01.26.43
curved	TS.01.27.40	TS.01.27.43

# SCISSORS



MAYO  
"TC"

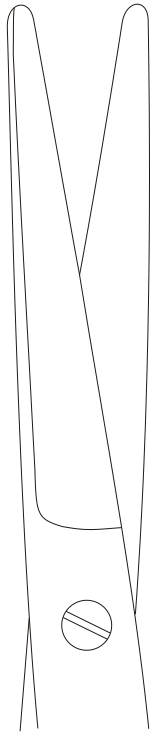

32 cm / 12½"



TS.01.28.73



TS.01.28.74

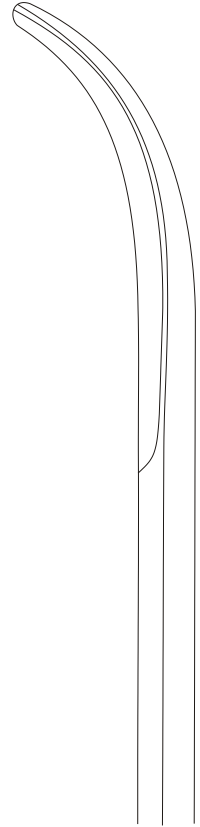

TS.01.28.75

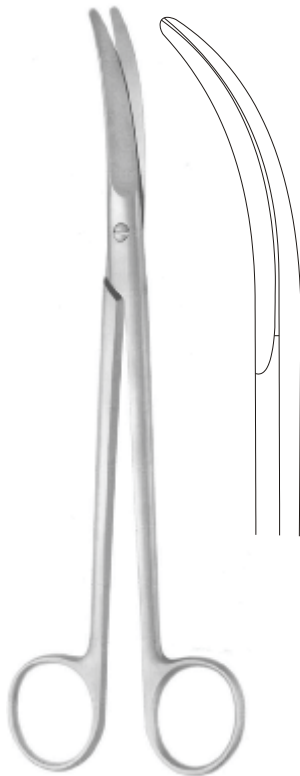

MAYO

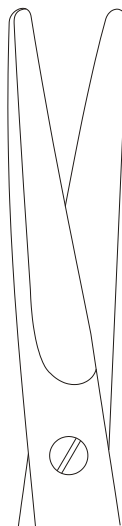

TS.01.29.118  
18 cm / 7¼"  
supercut

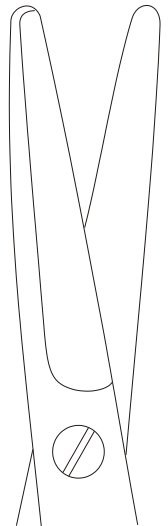

TS.01.29.123  
23 cm / 9"  
supercut

**SCISSORS**

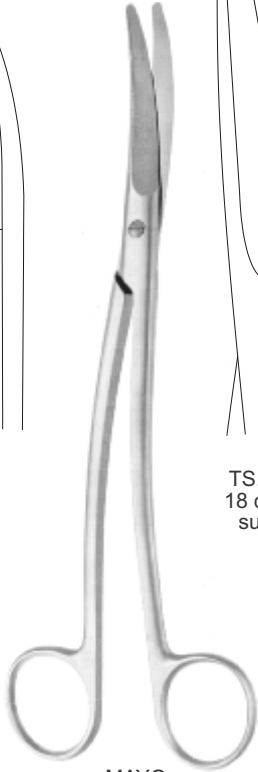
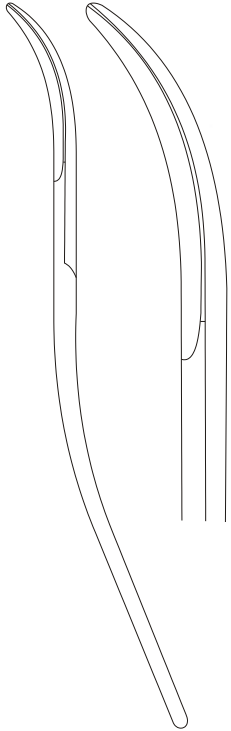

MAYO

TS.01.29.138  
 18 cm / 7 1/8"  
 supercut

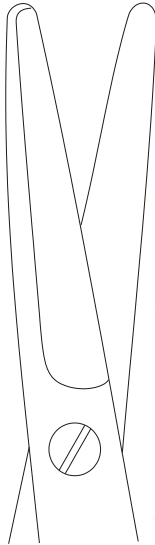
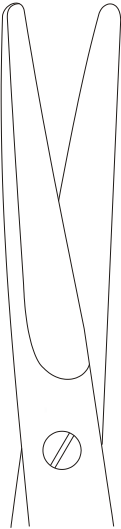

TS.01.29.143  
 23 cm / 9"  
 supercut

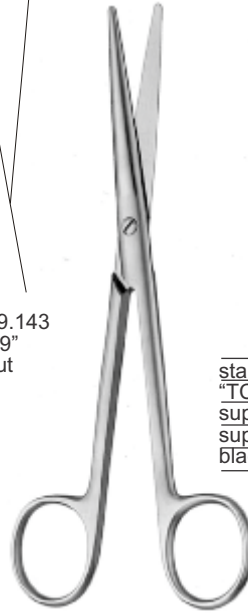

MAYO-LEXER  
 16 cm / 6 1/4"

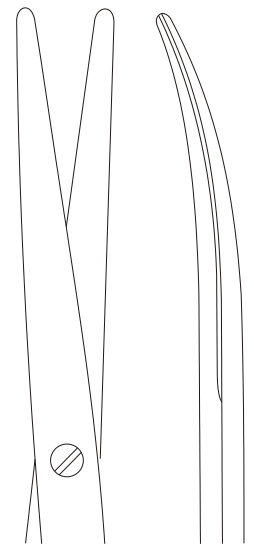

	straight	curved
standard	TS.01.32.86	TS.01.32.87
"TC"	TS.01.34.96	TS.01.35.96
supercut	TS.01.32.186	TS.01.32.187
supercut plus	TS.01.34.196	TS.01.35.196
black line	TS.01.32.286	TS.01.32.287



LEXER  
 16.5 cm / 6 1/2"



standard	TS.01.32.17
"TC"	TS.01.32.97
supercut	TS.01.32.117
supercut plus	TS.01.32.197
black line	TS.01.32.217



MAYO-NOBLE  
 17 cm / 6 3/4"

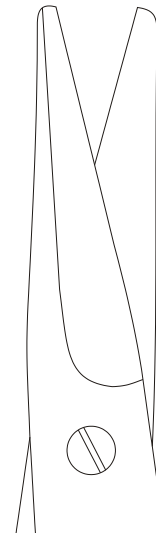

TS.01.33.17  
 straight



TS.01.34.17  
 curved

# SCISSORS



MAYO  
"TC"

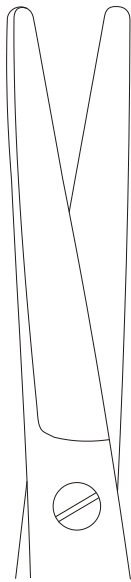

23 cm/ 9"



TS.01.26.73



TS.01.26.74



TS.01.26.75

Parametrium scissors

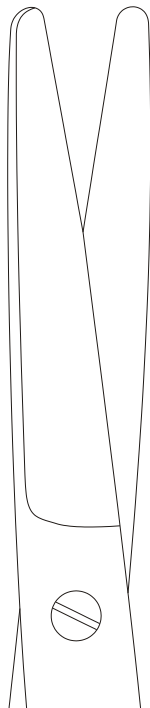

28 cm/ 11"



TS.01.27.73



TS.01.27.74

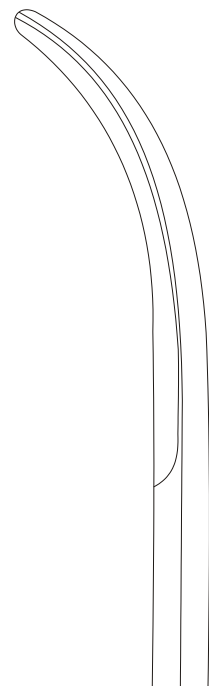

TS.01.27.75

# SCISSORS

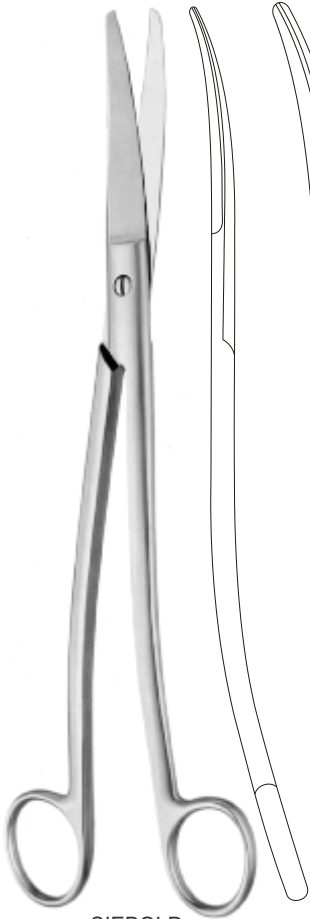

SIEBOLD

24.5 cm/ 9<sup>3</sup>/<sub>4</sub>"

standard	TS.01.27.24
supercut	TS.01.27.124

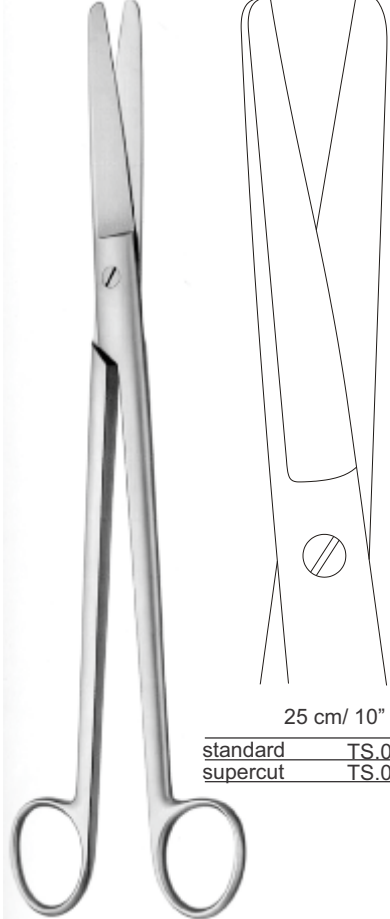

SIMS-SIEBOLD

25 cm/ 10"

standard	TS.01.27.25
supercut	TS.01.27.125



RESANO

25 cm/ 10"

supercut	TS.01.27.135
black line	TS.01.27.235



MAYO-STILLE



	straight 15 cm/ 6"	curved 15 cm/ 6"	straight 17 cm/ 6 <sup>3</sup> / <sub>4</sub> "	curved 17 cm/ 6 <sup>3</sup> / <sub>4</sub> "	straight 23 cm/ 9"	curved 23 cm/ 9"
standard	TS.01.28.15	TS.01.30.15	TS.01.28.17	TS.01.30.17	TS.01.28.23	TS.01.30.23
"TC"	TS.01.29.65	TS.01.31.65	TS.01.29.67	TS.01.31.67		
supercut	TS.01.28.115	TS.01.30.115	TS.01.28.117	TS.01.30.117		
supercut plus	TS.01.29.165	TS.01.31.165	TS.01.29.167	TS.01.31.167		
black line	TS.01.28.215	TS.01.30.215	TS.01.28.217	TS.01.30.217		



MAYO-STILLE

# SCISSORS



standard	TS.01.36.11	TS.01.37.11
"TC"	TS.01.36.61	TS.01.37.61
supercut	TS.01.36.111	TS.01.37.111
supercut plus	TS.01.36.161	TS.01.37.161
black line	TS.01.36.211	TS.01.37.211

**BABY-METZENBAUM**  
11.5 cm/ 4½"

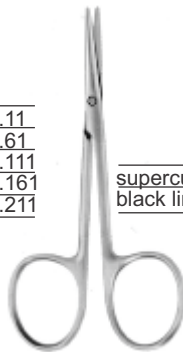

	straight	curved
supercut	TS.01.36.109	TS.01.37.109
black line	TS.01.36.209	TS.01.37.209

**MINI-METZENBAUM**  
9 cm/ 3½"

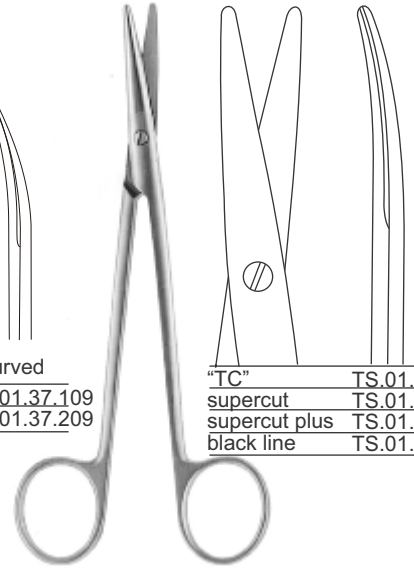

"TC"	TS.01.37.63
supercut	TS.01.39.113
supercut plus	TS.01.37.163
black line	TS.01.39.213

**METZENBAUM**  
14 cm/ 5½"



**METZENBAUM**

	straight	straight	straight	curved	curved	curved	curved
	14 cm/ 5½"	18 cm/ 7½"	20cm/ 8"	14 cm/ 5½"	15 cm/ 6"	18 cm/ 7½"	20cm/ 8"
standard	TS.01.36.14	TS.01.38.18	TS.01.38.20	TS.01.37.14	TS.01.37.15	TS.01.39.18	TS.01.39.20
"TC"	TS.01.36.64	TS.01.38.68	TS.01.38.70	TS.01.37.64		TS.01.39.68	TS.01.39.70
supercut	TS.01.36.114	TS.01.38.118	TS.01.38.120	TS.01.37.114	TS.01.37.115	TS.01.39.118	TS.01.39.120
supercut plus	TS.01.36.164	TS.01.38.168	TS.01.38.170	TS.01.37.164		TS.01.39.168	TS.01.39.170
black line	TS.01.36.214	TS.01.38.218	TS.01.38.220	TS.01.37.214	TS.01.37.215	TS.01.39.218	TS.01.39.220

**SCISSORS**

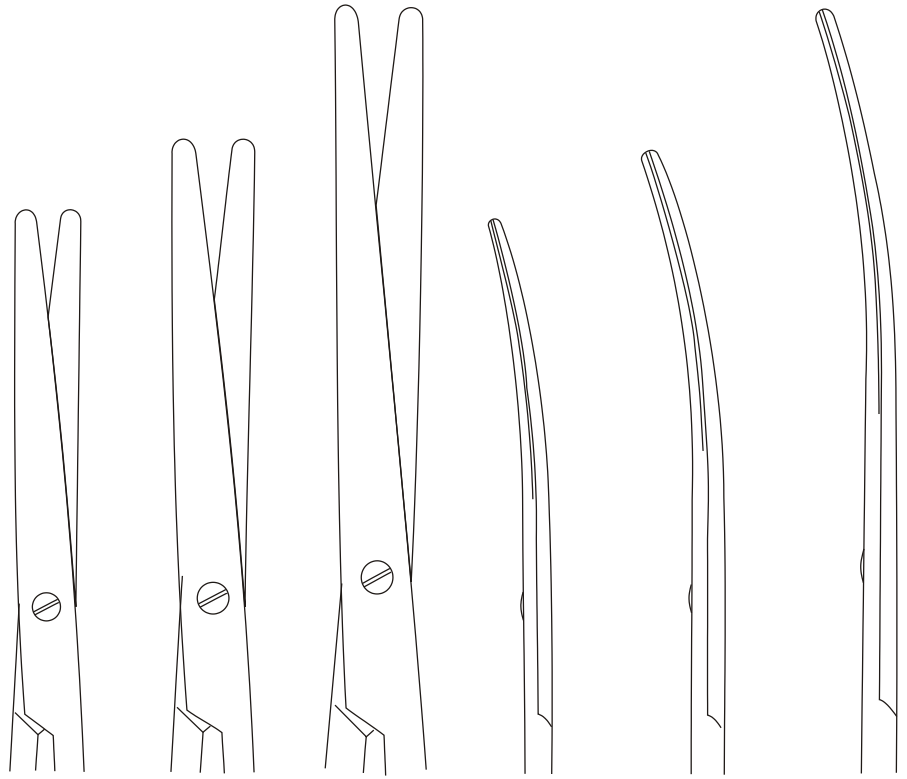

	straight 23 cm/ 9"	straight 26 cm/ 10¼"	straight 30cm/ 11¾"	curved 23 cm/ 9"	curved 26 cm/ 10¼"	curved 30cm/ 11¾"
standard	TS.01.40.23	TS.01.40.26	TS.01.40.30	TS.01.41.23	TS.01.41.26	TS.01.41.30
"TC"	TS.01.40.73	TS.01.40.76	TS.01.40.80	TS.01.41.73	TS.01.41.76	TS.01.41.80
supercut	TS.01.40.123	TS.01.40.126	TS.01.40.130	TS.01.41.123	TS.01.41.126	TS.01.41.130
supercut plus	TS.01.40.173	TS.01.40.176	TS.01.40.180	TS.01.41.173	TS.01.41.176	TS.01.41.180
black line	TS.01.40.223	TS.01.40.226	TS.01.40.230	TS.01.41.223	TS.01.41.226	TS.01.41.230

NELSON-METZENBAUM

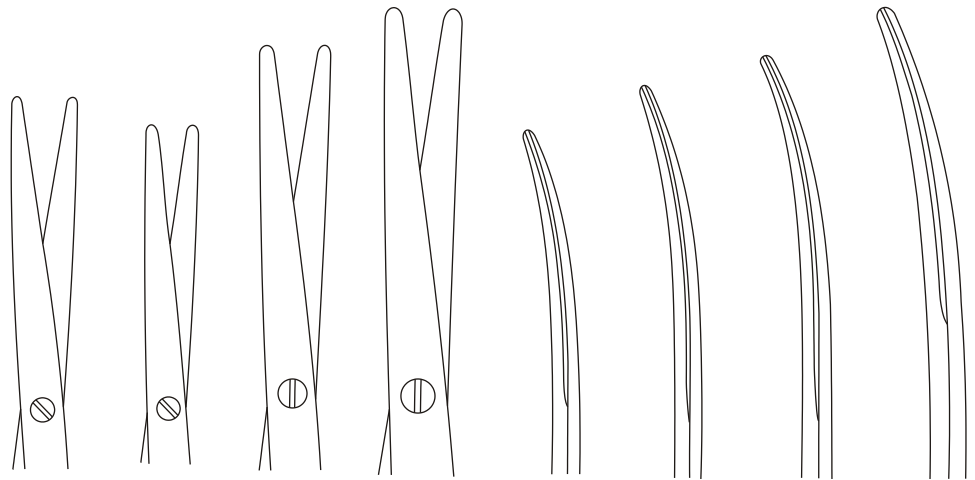

	straight 14 cm/ 5½"	straight 18 cm/ 7⅞"	straight 20cm/ 8"	straight 23 cm/ 9"	curved 14 cm/ 5½"	curved 18 cm/ 7⅞"	curved 20cm/ 8"	curved 23 cm/ 9"
standard	TS.01.42.14	TS.01.44.18	TS.01.44.20	TS.01.44.23	TS.01.43.14	TS.01.45.18	TS.01.45.20	TS.01.45.23
"TC"	TS.01.42.64	TS.01.44.68	TS.01.44.70	TS.01.44.73	TS.01.43.64	TS.01.45.68	TS.01.45.70	TS.01.45.73
supercut	TS.01.42.114	TS.01.44.118	TS.01.44.120	TS.01.44.123	TS.01.43.114	TS.01.45.118	TS.01.45.120	TS.01.45.123
supercut plus	TS.01.42.164	TS.01.44.168	TS.01.44.170	TS.01.44.173	TS.01.43.164	TS.01.45.168	TS.01.45.170	TS.01.45.173
black line	TS.01.42.214	TS.01.44.218	TS.01.44.220	TS.01.44.223	TS.01.43.214	TS.01.45.218	TS.01.45.220	TS.01.45.223

METZENBAUM-SLIM



# SCISSORS

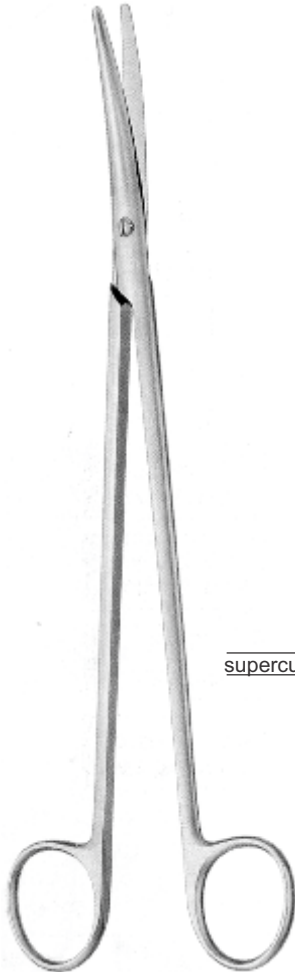

METZENBAUM-SLIM

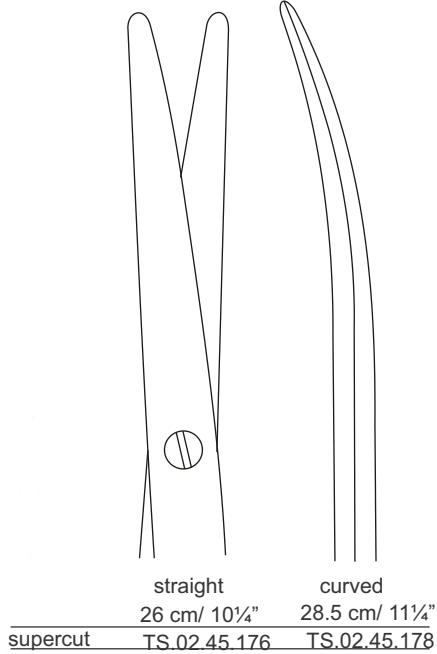

KELLY  
16 cm/ 6¼"

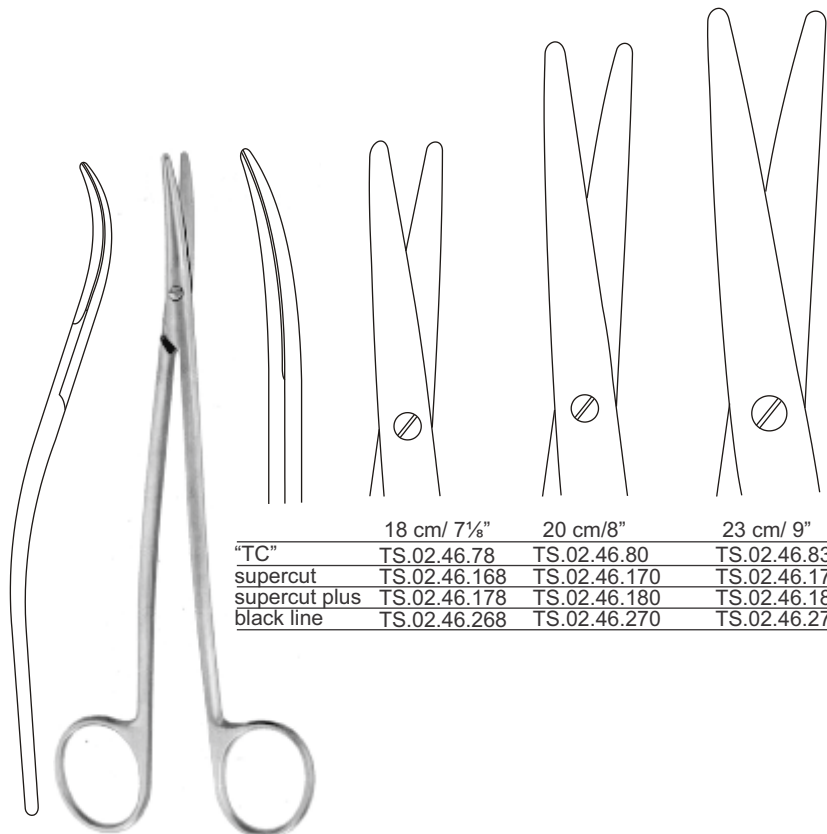
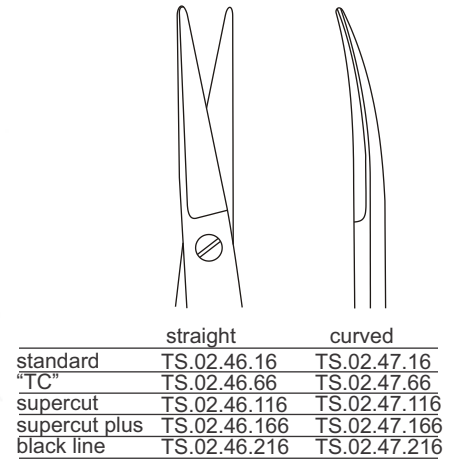

METZENBAUM

**SCISSORS**

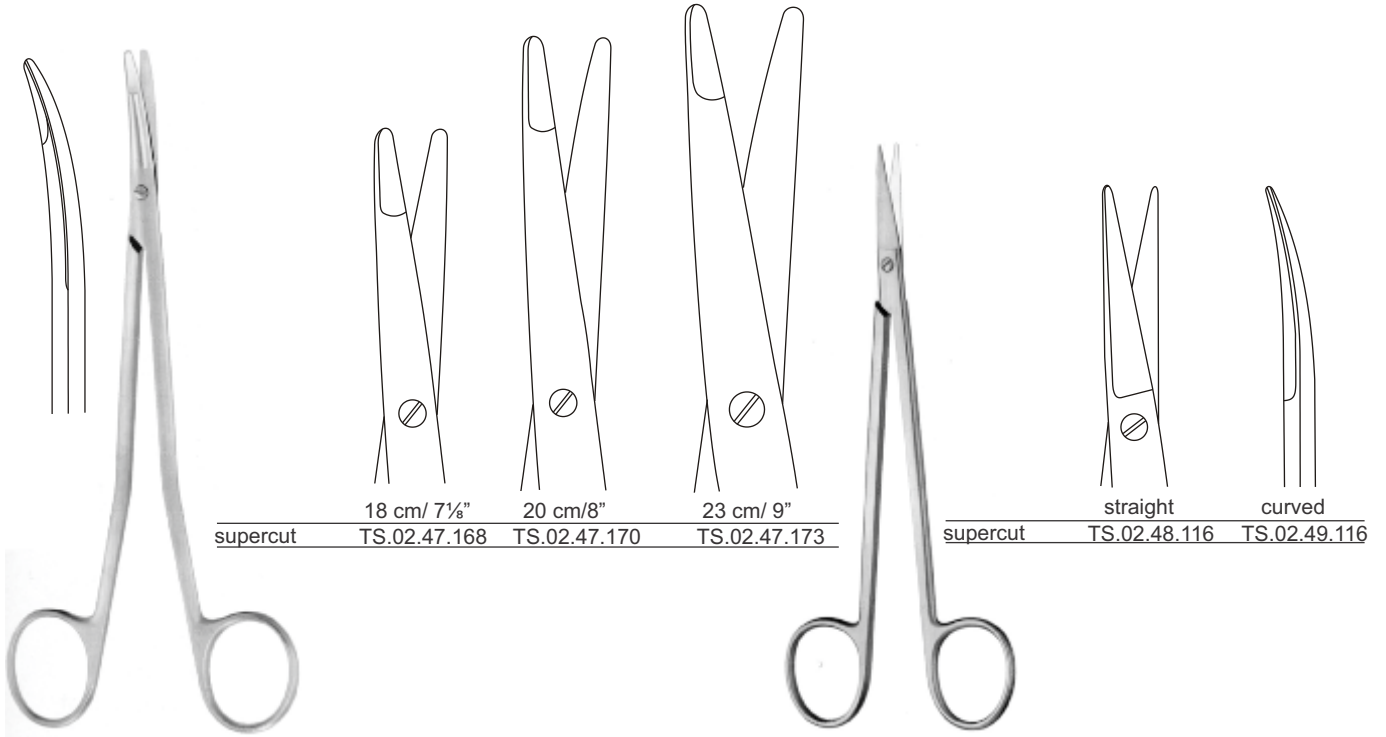

supercut	18 cm/ 7 1/8"	20 cm/8"	23 cm/ 9"
	TS.02.47.168	TS.02.47.170	TS.02.47.173

supercut	straight	curved
	TS.02.48.116	TS.02.49.116

METZENBAUM-FREEMAN

BRÜSER-KELLY

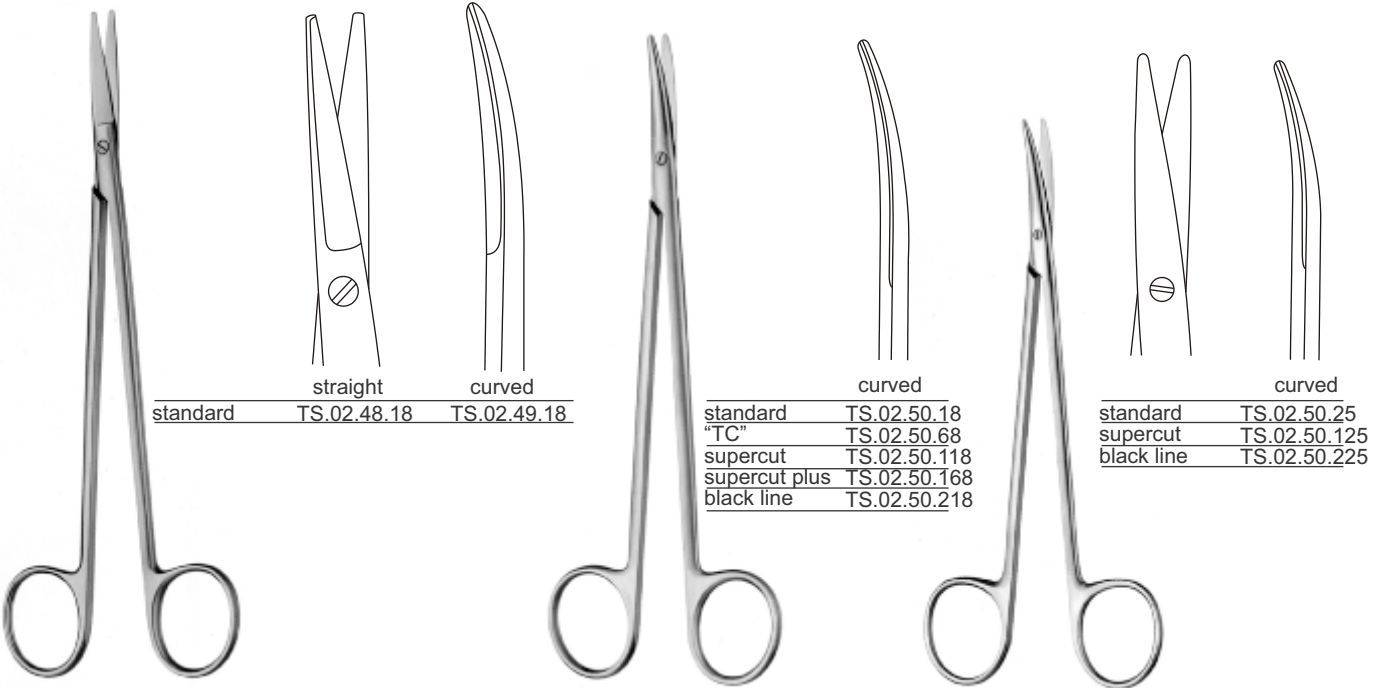

standard	straight	curved
	TS.02.48.18	TS.02.49.18

standard	curved
"TC"	TS.02.50.18
supercut	TS.02.50.68
supercut plus	TS.02.50.118
black line	TS.02.50.168
	TS.02.50.218

standard	curved
supercut	TS.02.50.25
black line	TS.02.50.125
	TS.02.50.225

HOUSE-TOENNIS  
18 cm/ 7 1/8"

TOENNIS-ADSON  
18 cm/7 1/8"

15 cm/ 6"

# SCISSORS

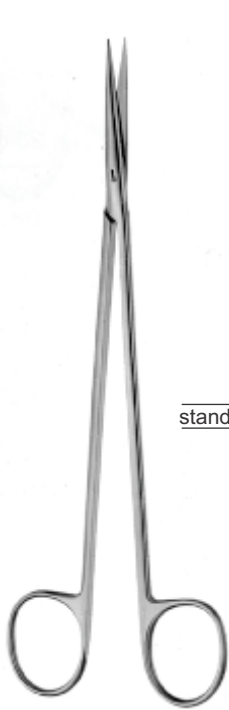

DEMARTEL  
18 cm / 7 1/8"

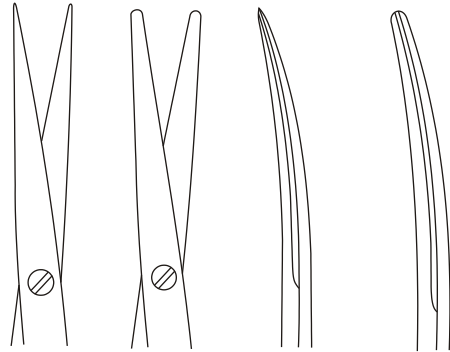

straight	straight	curved	curved
standard	TS.02.50.78	TS.02.50.79	TS.02.51.78
		TS.02.51.79	

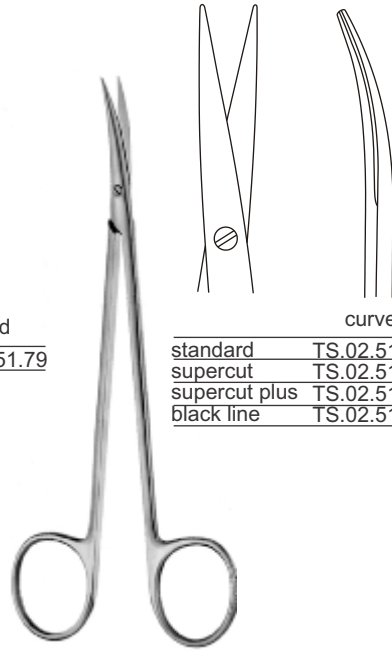

15 cm / 6"

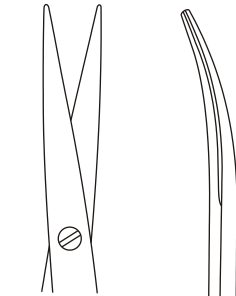

curved	
standard	TS.02.51.15
supercut	TS.02.51.115
supercut plus	TS.02.51.165
black line	TS.02.51.215

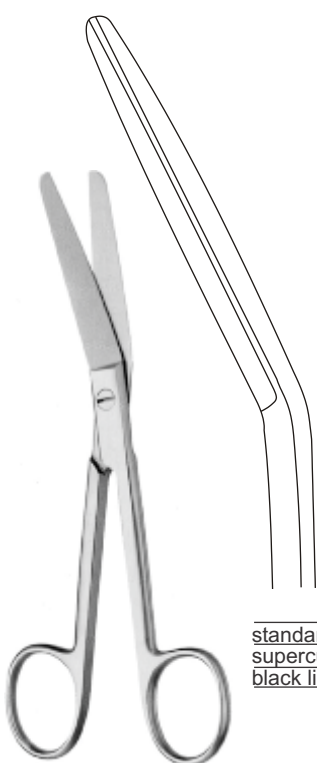

16.5 cm / 6 1/2"

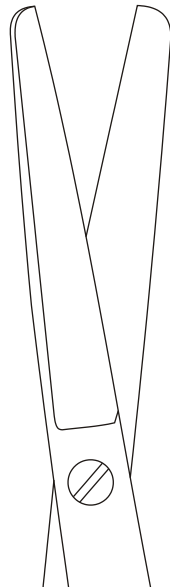

standard	TS.02.57.16
supercut	TS.02.57.116
black line	TS.02.57.216

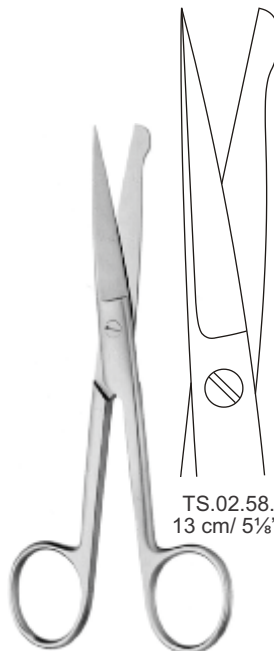

TS.02.58.13  
13 cm / 5 1/4"



TS.02.58.14  
14.5 cm / 5 3/4"

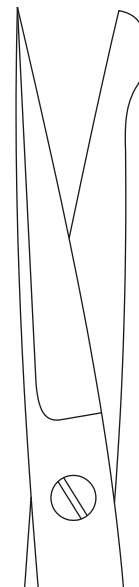

TS.02.58.16  
16.5 cm / 6 1/2"

Incision scissors

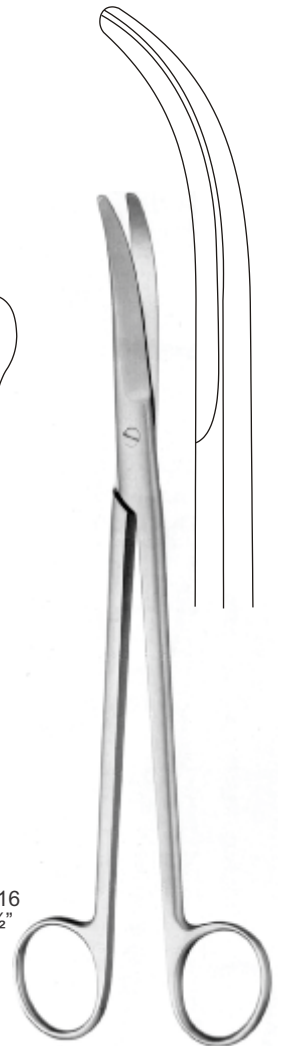

JORGENSON  
TS.02.53.93  
23 cm / 9"

**SCISSORS**

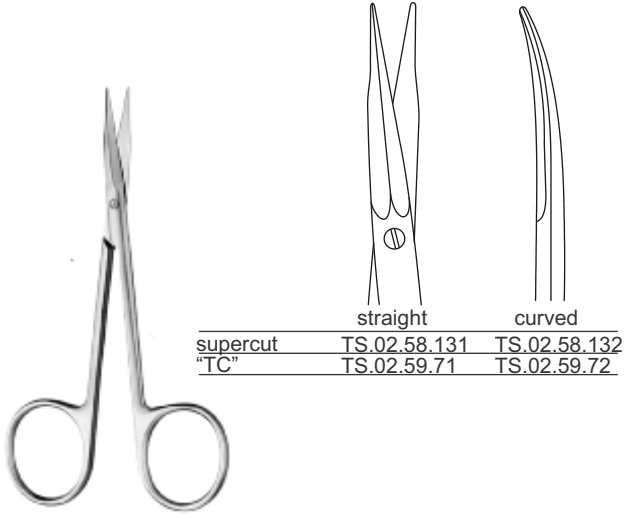

	straight	curved
supercut	TS.02.58.131	TS.02.58.132
"TC"	TS.02.59.71	TS.02.59.72

**SIEBERT**  
11.5 cm / 4½"

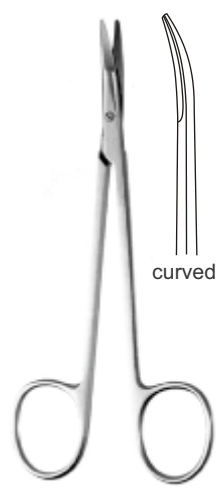

curved

**SHEA**  
TS.02.59.12  
12 cm / 4¾"



curved

supercut	TS.02.60.122
supercut plus	TS.02.61.122
black line	TS.02.60.222

**GREENBERG PAR**  
11.5 cm / 4½"

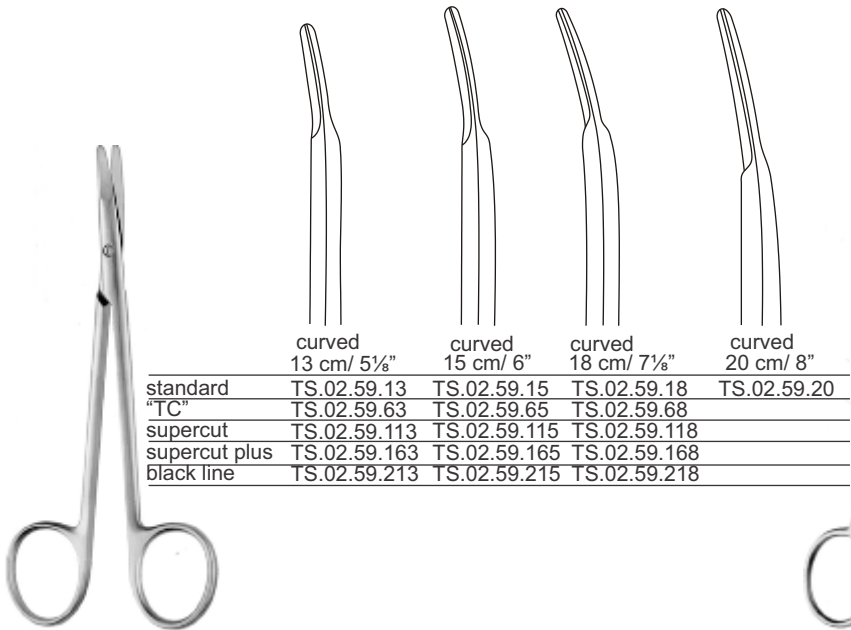

	curved 13 cm / 5⅛"	curved 15 cm / 6"	curved 18 cm / 7⅛"	curved 20 cm / 8"
standard	TS.02.59.13	TS.02.59.15	TS.02.59.18	TS.02.59.20
"TC"	TS.02.59.63	TS.02.59.65	TS.02.59.68	
supercut	TS.02.59.113	TS.02.59.115	TS.02.59.118	
supercut plus	TS.02.59.163	TS.02.59.165	TS.02.59.168	
black line	TS.02.59.213	TS.02.59.215	TS.02.59.218	

**RAGNELL (KILNER)**

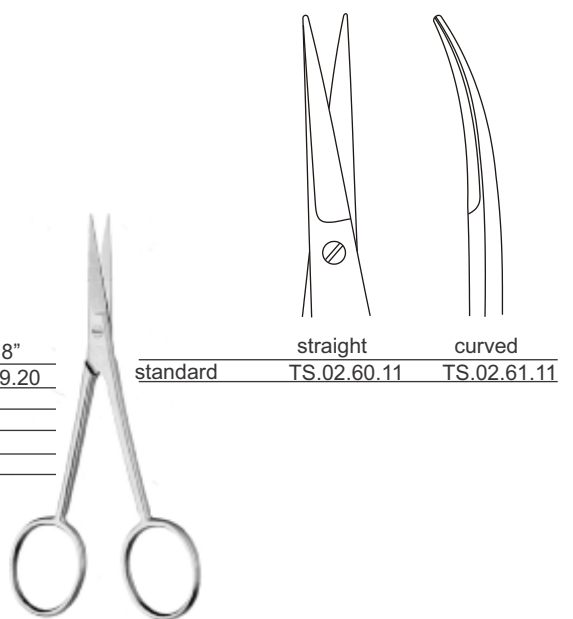

straight

curved

standard	TS.02.60.11	TS.02.61.11
----------	-------------	-------------

11 cm / 4¼"

# SCISSORS

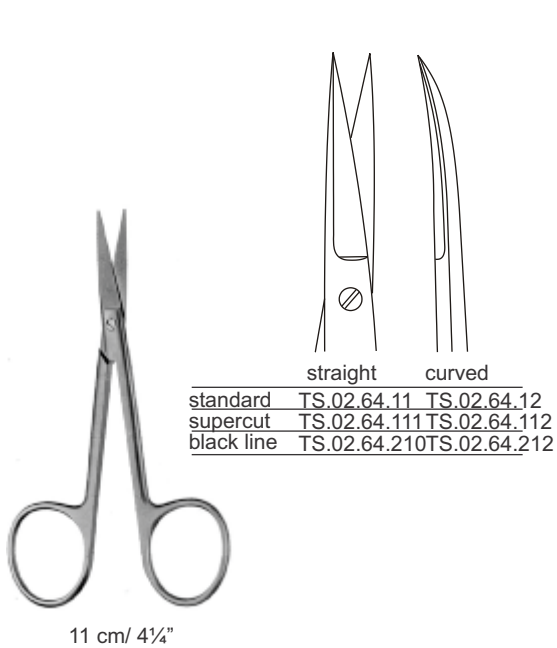
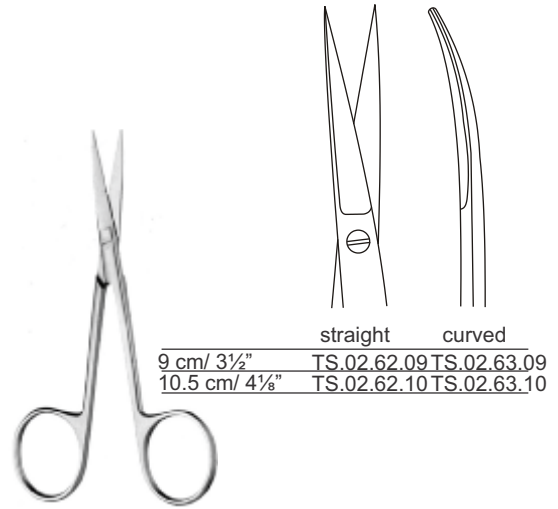
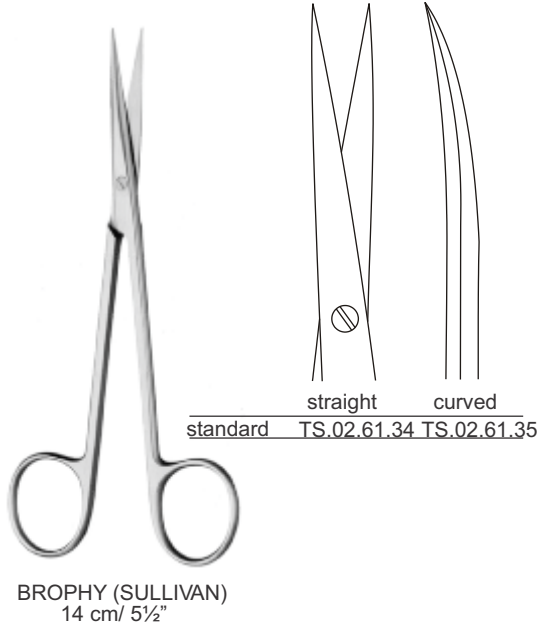

**SCISSORS**

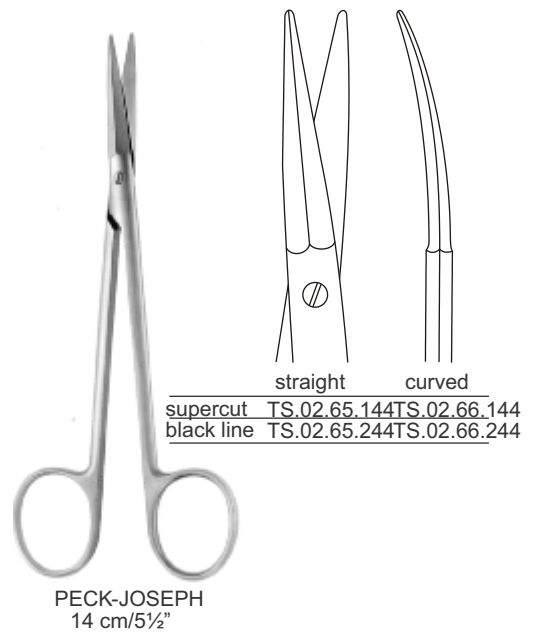
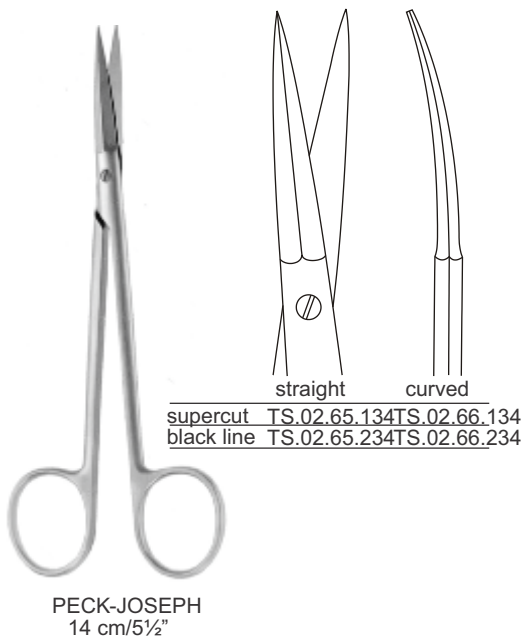
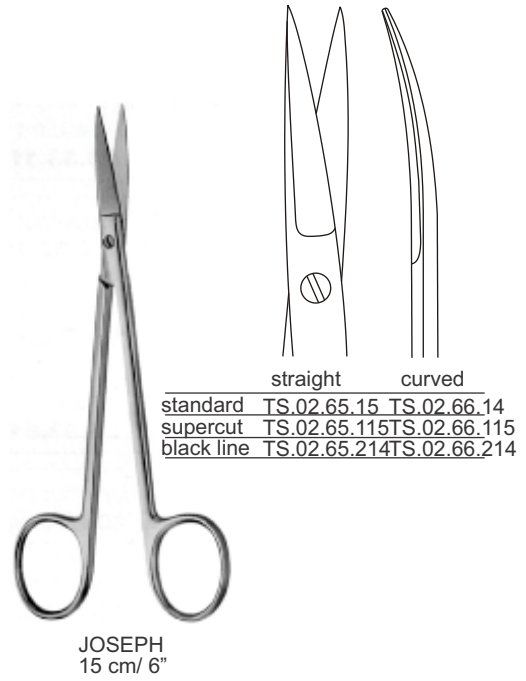
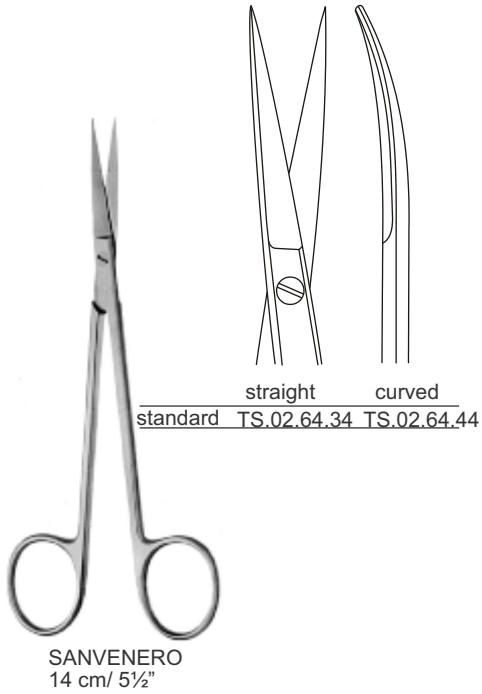

# SCISSORS



"SLIM"

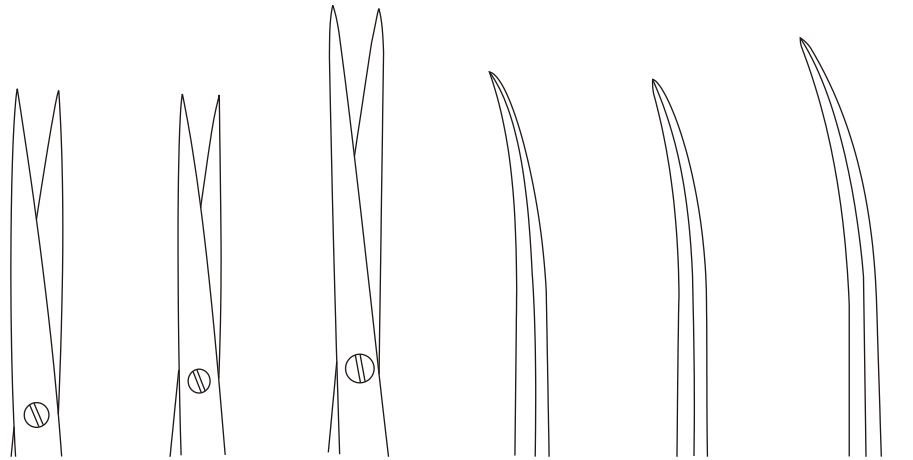

straight

straight

straight

curved

curved

curved

14 cm/ 5½"

18 cm/ 7¼"

20 cm/ 8"

14 cm/5½"

18 cm/ 7¼"

20 cm/ 8"

standard	TS.02.67.14	TS.02.67.18	TS.02.67.20	TS.02.68.14	TS.02.68.18	TS.02.68.20
"TC"	TS.02.67.64			TS.02.68.64		
supercut	TS.02.67.114			TS.02.68.114	TS.02.68.118	
supercut plus	TS.02.67.164			TS.02.68.164		



JAMESON  
15 cm/ 6"



supercut TS.02.69.117  
black line TS.02.69.217



JAMESON  
18 cm/ 7¼"



supercut TS.02.70.118  
black line TS.02.70.218

**SCISSORS**



REYNOLDS (JAMESON)

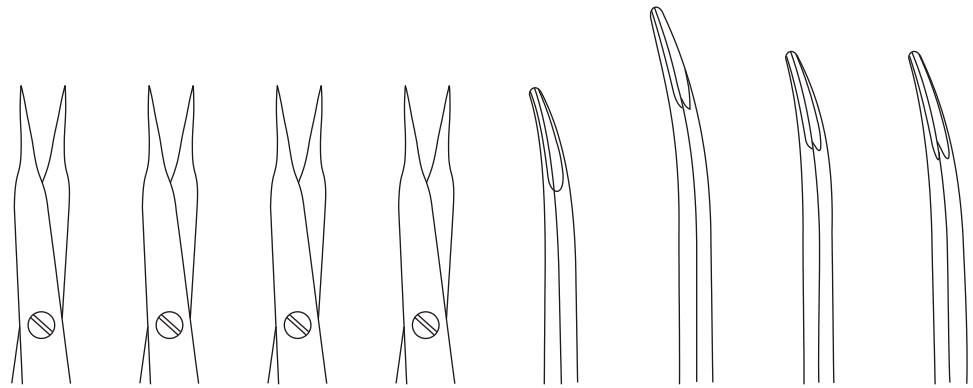

	12 cm/ 4½"	14 cm/ 5½"	16 cm/ 6¼"	18 cm/ 7⅞"	12 cm/ 4½"	14 cm/ 5½"	16 cm/ 6¼"	18 cm/ 7⅞"
standard	TS.02.72.12	TS.02.72.14	TS.02.72.16	TS.02.72.18	TS.02.73.12	TS.02.73.14	TS.02.73.16	TS.02.73.18
supercut					TS.02.73.112		TS.02.73.116	TS.02.73.118
black line					TS.02.73.212		TS.02.73.216	TS.02.73.218

flat tips



FANOUS

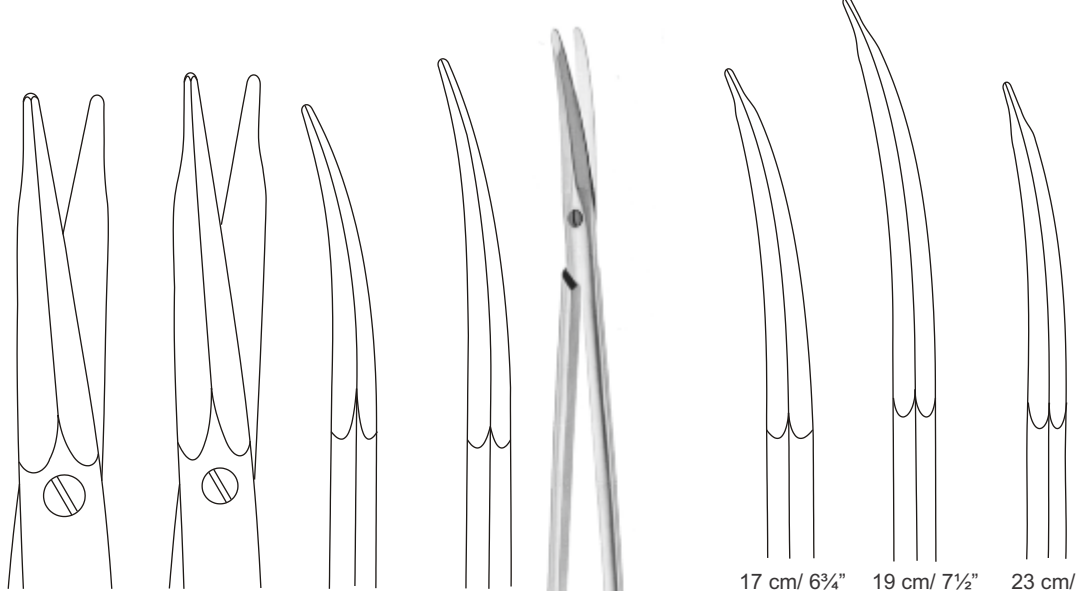

	16.5 cm/ 6½"	20.5 cm/ 8"	16.5 cm/ 6½"	20.5 cm/ 8"	17 cm/ 6¾"	19 cm/ 7½"	23 cm/ 9"
supercut	TS.02.74.116	TS.02.74.120	TS.02.74.126	TS.02.74.130	TS.02.77.127	TS.02.77.129	TS.02.77.133
"TC"					TS.02.77.67	TS.02.77.69	TS.02.77.73
black line					TS.02.77.227	TS.02.77.229	TS.02.77.233

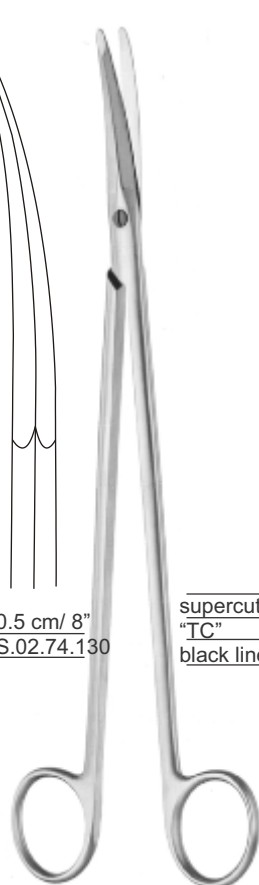

GORNEY  
FACE LIFT



# SCISSORS

flat tips

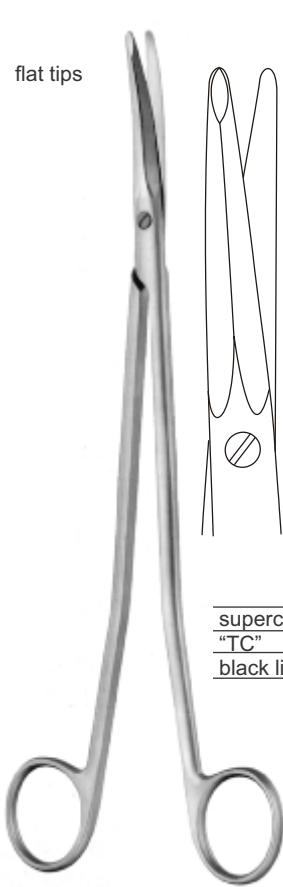

**GORNEY-FREEMAN  
FACE LIFT**

	17 cm/ 6 <sup>3</sup> / <sub>4</sub> "	19 cm/ 7 <sup>1</sup> / <sub>2</sub> "	23 cm/ 9"
supercut	TS.02.80.117	TS.02.80.119	TS.02.80.123
"TC"	TS.02.80.37	TS.02.80.39	TS.02.80.43
black line	TS.02.80.217	TS.02.80.219	TS.02.80.223

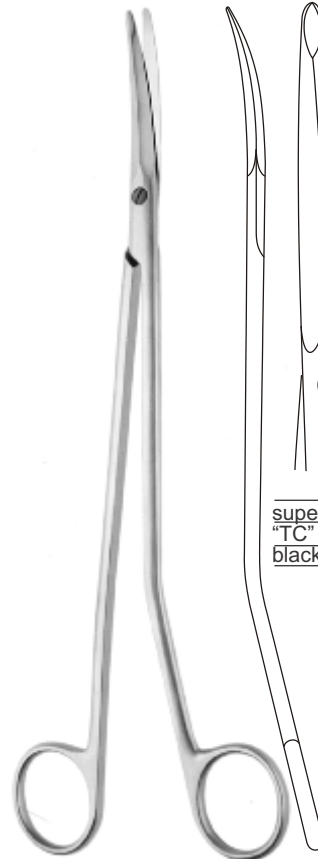

**GORNEY-FREEMAN  
23 cm/ 9"**

supercut	TS.02.80.152
"TC"	TS.02.80.72
black line	TS.02.82.252

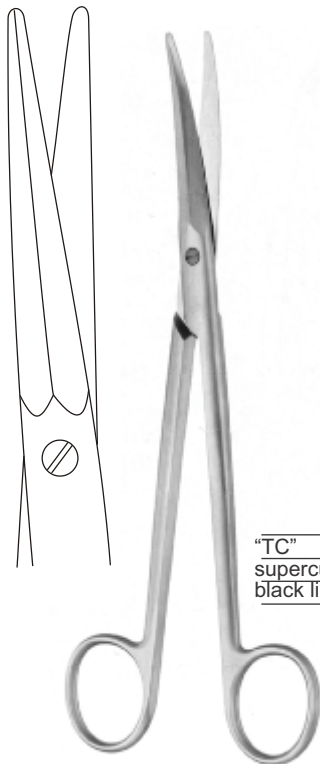

**KAYE  
FACE LIFT**

	15 cm/ 6"	17 cm/ 6 <sup>3</sup> / <sub>4</sub> "	19 cm/ 7 <sup>1</sup> / <sub>2</sub> "	23 cm/ 9"
"TC"	TS.02.81.115	TS.02.81.117	TS.02.81.119	TS.02.81.123
supercut	TS.02.81.115	TS.02.81.117	TS.02.81.119	TS.02.81.123
black line	TS.02.81.215	TS.02.81.217	TS.02.81.219	TS.02.81.223



**KAYE  
11.5 cm/ 4<sup>1</sup>/<sub>2</sub>"**

supercut	TS.02.81.132
black line	TS.02.81.232

**SCISSORS**



	straight	curved
standard	TS.02.90.13	TS.02.91.13
"TC"	TS.02.90.63	TS.02.91.63
supercut	TS.02.90.113	TS.02.91.113
supercut plus	TS.02.90.163	TS.02.91.163
black line	TS.02.90.213	TS.02.91.213

**FOX**  
13 cm / 5 1/8"

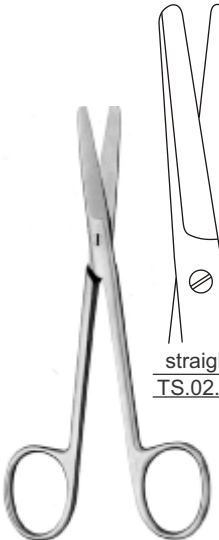

	straight	curved
	TS.02.95.02	TS.02.96.02

**WAGNER**  
12 cm / 4 3/4"

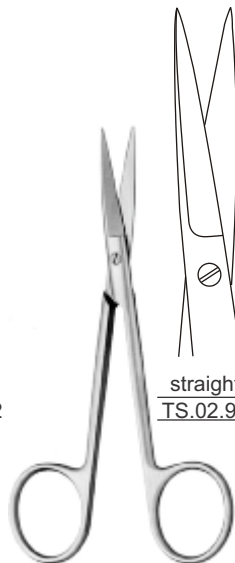

	straight	curved
	TS.02.95.12	TS.02.96.12

**WAGNER**  
12 cm / 4 3/4"

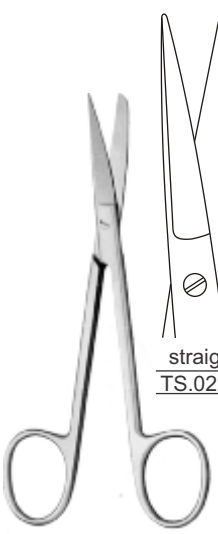

	straight	curved
	TS.02.95.32	TS.02.96.32

**WAGNER**  
12 cm / 4 3/4"

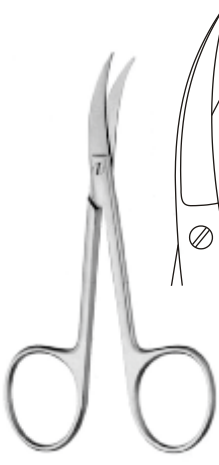

TS.02.96.80  
10.5cm / 4 1/8"



	straight	curved
	TS.02.110.13	TS.02.111.13

**QUIMBY**  
13 cm / 5 1/8"

# SCISSORS



LOCKLIN  
16 cm / 6¼"

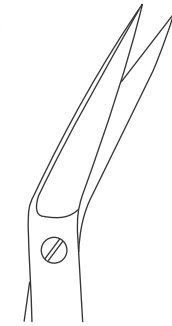

TS.02.115.15

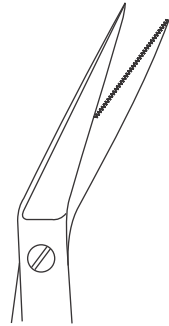

TS.02.115.16

serrated cutting edges



LOCKLIN  
16 cm / 6¼"

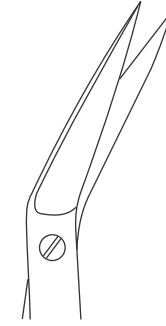

TS.02.116.26

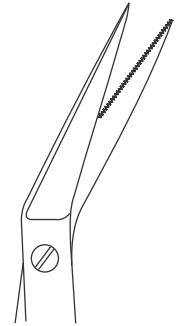

TS.02.116.27

serrated cutting edges



12 cm / 4¾"

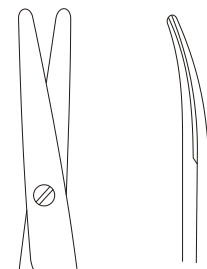

standard	TS.02.196.42	TS.02.196.43
"TC"	TS.02.196.62	TS.02.196.63
supercut	TS.02.196.142	TS.02.196.143
supercut plus	TS.02.196.162	TS.02.196.163

## Micro Scissors



# Micro Scissors



MICRO 2000  
15 cm / 6"



TS.02.01.20  
standard

TS.02.01.120  
supercut



TS.02.01.21  
standard

TS.02.01.121  
supercut



TS.02.01.22  
standard

serrated cutting edges



TS.02.01.23  
standard



TS.02.01.30  
standard

Vannas-type cutting edges

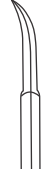

TS.02.01.31  
standard



TS.02.02.20  
standard



TS.02.02.21  
standard

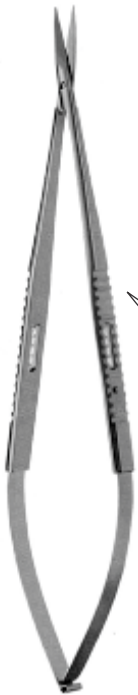

JACOBSON  
MICRO 2000  
18 cm / 7 1/2"



TS.02.07.20



TS.02.07.21



TS.02.07.25

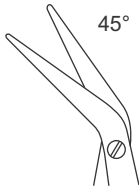

TS.02.07.26



MICRO 2000  
12.5 cm / 5"



TS.02.03.22  
standard

serrated cutting edges



TS.02.03.23  
standard



TS.02.04.30  
standard

Vannas-type cutting edges



TS.02.04.31  
standard



TS.02.05.25  
standard



TS.02.05.28  
standard



TS.02.06.29  
standard

# Micro Scissors



Vannas-type cutting edges

**KOSHIMA**  
TS.02.06.34  
15 cm/ 6"



**KOSHIMA**  
TS.02.06.32  
15 cm/ 6"



**YASARGIL**  
12 cm/ 4 3/4"



TS.02.05.40



TS.02.05.41

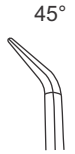

TS.02.05.55

45°



TS.02.05.50



TS.02.05.51

Vannas-type cutting edges



**YASARGIL**  
15 cm/ 6"



TS.02.01.40



TS.02.01.41



TS.02.01.50



TS.02.01.51

Vannas-type cutting edges



12 cm/ 4 3/4"



TS.02.08.84



TS.02.08.85



TS.02.08.88



TS.02.08.87

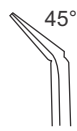

TS.02.08.89

45°

Vannas-type cutting edges

# Micro Scissors

Vein scissors



**BIEMER**  
TS.02.08.90  
13 cm / 5 1/8"

16 cm / 6 1/4"

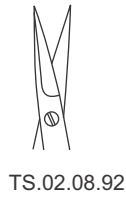

TS.02.08.92



TS.02.08.93



TS.02.08.94

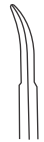

TS.02.08.95

Vannas-type cutting edges

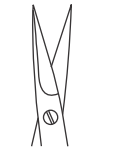

TS.02.08.96



TS.02.08.97

**MILLESI**

serrated cutting edges



**YASARGIL**  
TS.02.08.98



**JACOBSON**  
TS.02.08.99

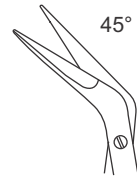

**POTTS-YASARGIL**  
TS.02.09.01



18.5 cm / 7 1/4"



TS.02.09.10  
18.5 cm / 7 1/4"

# Micro Scissors



15 cm/ 6"  
 Round handle Ø 8 mm



TS.02.01.74  
 standard



TS.02.01.75  
 standard



TS.02.01.76  
 standard



TS.02.01.77  
 standard

Vannas-type cutting edges

TS.02.01.174  
 supercut



MICRO SCISSORS  
 TS.02.12.12  
 12 cm/ 4¾"

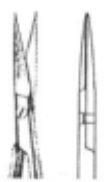

MICRO SCISSORS  
 TS.02.13.12  
 12 cm/ 4¾"



TS.02.08.02  
 23 cm/ 9"  
 Round Handle Ø 8 mm



# Scalpels, Knives



Scalpels, Knives

# Scalpels, Knives



13 cm/ 5 1/8"



TS.02.01.01  
# 1



TS.02.01.02  
# 2



TS.02.01.03  
# 3



TS.02.01.04  
# 4



TS.02.01.07  
# 7



TS.02.01.08  
# 8



TS.02.01.09  
# 9



TS.02.01.10  
# 10



**PARKER**  
14 cm/ 5 1/2"



TS.02.02.07  
# 1



TS.02.02.09  
# 2



**ADAMS**  
15 cm/ 6"



TS.02.13.51  
# 1



TS.02.13.52  
# 2



TS.02.13.53  
# 3



TS.02.13.54  
# 4

# Scalpels, Knives



TS.02.03.10  
# 10



TS.02.03.11  
# 11



TS.02.03.12  
# 12



TS.02.03.13  
# 12d



TS.02.03.15  
# 15



TS.02.03.18  
# 18



TS.02.03.19  
# 19



TS.02.03.20  
# 20



TS.02.03.21  
# 12d



TS.02.03.22  
# 22



TS.02.03.23  
# 23



TS.02.03.24  
# 24



TS.02.03.25  
# 25



TS.02.03.36  
# 36

# Scalpels, Knives



BARRON  
 TS.02.10.84  
 13 cm / 5 1/8"



TS.02.04.03  
 # 3  
 12.5 cm / 5"



TS.02.04.04  
 # 3  
 12.5 cm / 5"



TS.02.05.07  
 # 7  
 16.5 cm / 6 1/2"



TS.02.06.17  
 # 7K  
 12 cm / 4 3/4"



TS.02.07.13  
 # 3L  
 21 cm / 8 1/4"



TS.02.08.23  
 # 3LA  
 20.5 cm / 8"

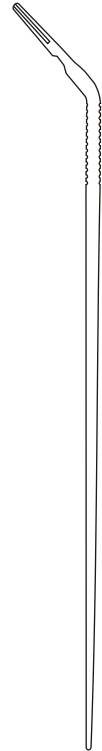

TS.02.09.04  
 # 4  
 13.5 cm / 5 3/8"



TS.02.10.40  
 15.5 cm / 6 1/8"



TS.02.10.22  
 22.5 cm / 9"



TS.02.10.90  
 13 cm / 5 1/8"



TS.02.10.91  
 15.5 cm / 6 1/8"

# Scalpels, Knives



TS.02.10.45  
22.5 cm/ 9"



TS.02.10.53  
27 cm/ 10 $\frac{1}{4}$ "



TS.02.10.61  
21 cm/ 8 $\frac{1}{4}$ "



TS.02.10.63  
15.5 cm/ 6 $\frac{1}{4}$ "



TS.02.10.64  
# 4L  
21 cm/ 8 $\frac{1}{4}$ "

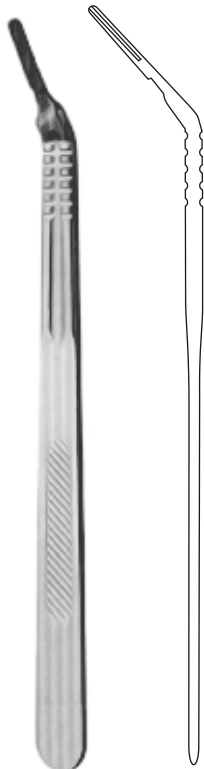

TS.02.10.74  
# 4LA  
20.5 cm/ 8 $\frac{1}{8}$ "



LANDOLT  
TS.02.10.86  
21 cm/ 8 $\frac{1}{4}$ "



LANDOLT  
TS.02.10.87  
25 cm/ 10"

# Scalpels, Knives



1/1

TS.02.10.92  
# 62



1/1

TS.02.10.94  
# 64



1/1

TS.02.10.95  
# 65



1/1

TS.02.10.97  
# 67



13.5 cm/ 5 1/4"



TS.02.11.01  
# 1



TS.02.11.02  
# 2



TS.02.11.03  
# 3



TS.02.11.05  
# 5



COLLIN  
16 cm/ 6 1/4"



TS.02.12.01  
# 1



TS.02.12.02  
# 2



TS.02.12.03  
# 3



TS.02.12.04  
# 4



TS.02.12.05  
# 5



TS.02.12.06  
# 6

# Scalpels, Knives

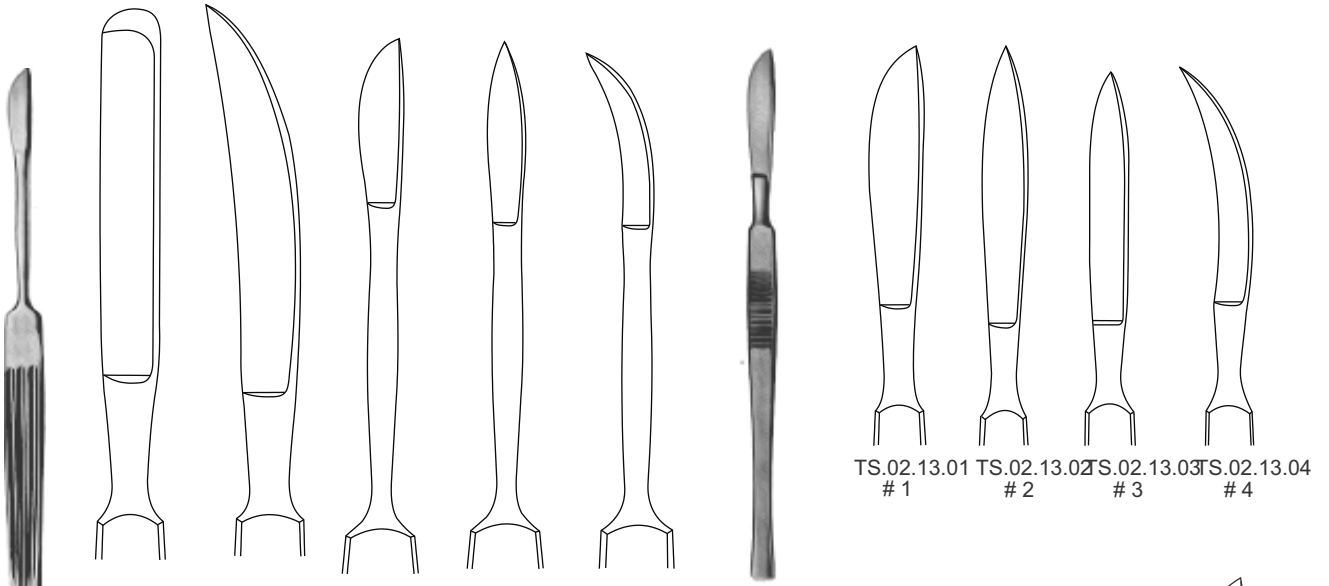

TS.02.12.38 # 38 TS.02.12.64 # 44 TS.02.12.61 # 61 TS.02.12.62 # 62 TS.02.12.63 # 63 BERGMANN 14 cm / 5 1/2"

17 cm / 6 3/4"



16 cm / 6 1/4"



TS.02.12.41 Fig. 1



TS.02.12.42 Fig. 2



TS.02.12.43 Fig. 3



TS.02.12.44 Fig. 4



TS.02.12.45 Fig. 5

1 1/1



TS.02.12.46 Fig. 6



TS.02.12.47 Fig. 7



TS.02.12.48 Fig. 8



TS.02.12.49 Fig. 9

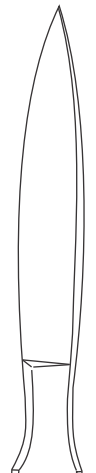

TS.02.12.50 Fig. 10

# Scalpels, Knives



17 cm/ 6¾"

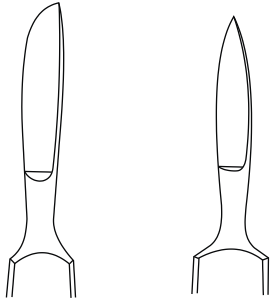

- |                 |                  |
|-----------------|------------------|
| TS.02.13.11 # 1 | TS.02.13.20 # 10 |
| TS.02.13.12 # 2 | TS.02.13.21 # 11 |
| TS.02.13.13 # 3 | TS.02.13.22 # 12 |
| TS.02.13.15 # 5 | TS.02.13.23 # 13 |
| TS.02.13.17 # 7 | TS.02.13.25 # 15 |
| TS.02.13.19 # 9 | TS.02.13.26 # 16 |

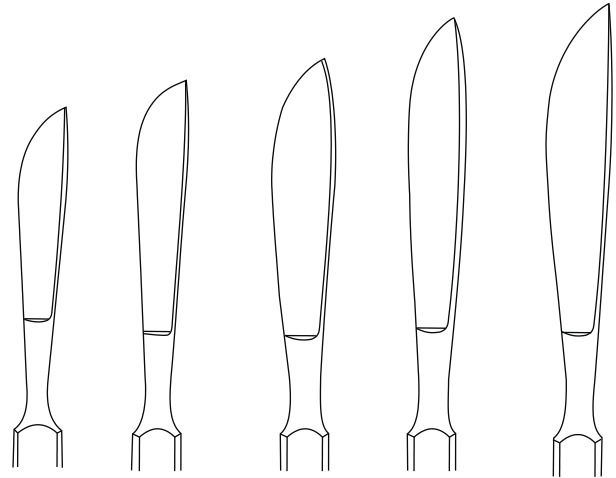

- |                 |                 |                 |                 |                 |
|-----------------|-----------------|-----------------|-----------------|-----------------|
| TS.02.13.31 # 1 | TS.02.13.32 # 2 | TS.02.13.33 # 3 | TS.02.13.34 # 4 | TS.02.13.35 # 5 |
|-----------------|-----------------|-----------------|-----------------|-----------------|



DIEFFENBACH  
 16 cm/ 6¼"

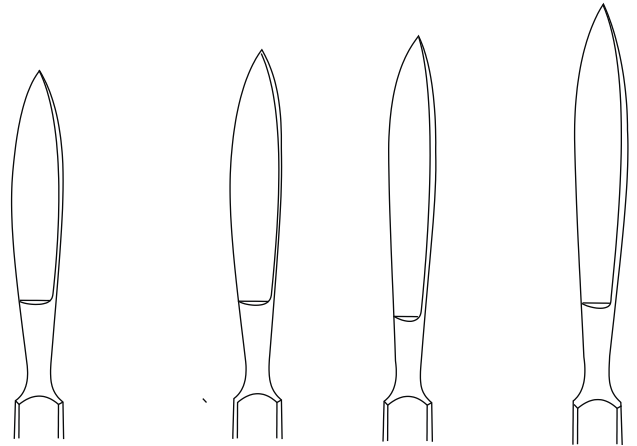

- |                 |                 |                 |                 |
|-----------------|-----------------|-----------------|-----------------|
| TS.02.13.36 # 6 | TS.02.13.37 # 7 | TS.02.13.38 # 8 | TS.02.13.39 # 9 |
|-----------------|-----------------|-----------------|-----------------|

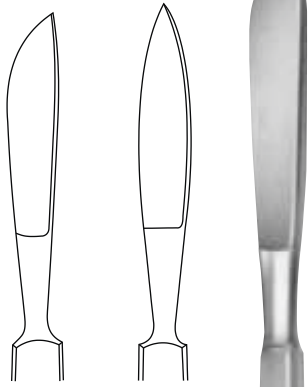

- TS.02.13.71 TS.02.13.72 TS.02.13.73



SIMON  
 20 cm/ 8"



# Scalpels, Knives

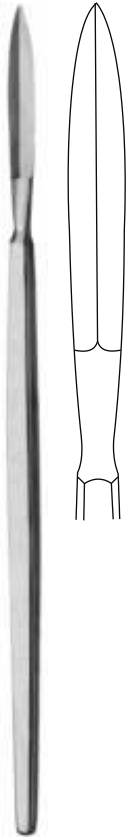

SCHROEDER  
TS.02.13.82  
22 cm / 8<sup>3</sup>/<sub>4</sub>"

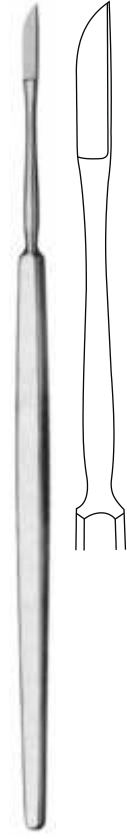

ULRICH  
TS.02.13.83  
22 cm / 8<sup>3</sup>/<sub>4</sub>"



SIMON  
TS.02.13.92  
22 cm / 8<sup>3</sup>/<sub>4</sub>"



CATLIN

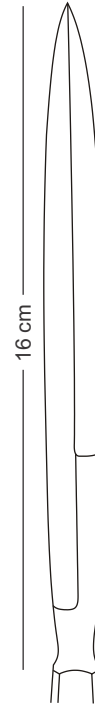

TS.02.14.16  
29 cm / 11<sup>1</sup>/<sub>2</sub>"



TS.02.14.22  
35 cm / 13<sup>3</sup>/<sub>4</sub>"



COLLIN  
TS.02.16.15  
27 cm / 10<sup>3</sup>/<sub>4</sub>"

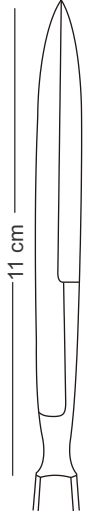

TS.02.15.11  
23 cm / 9"



# Scalpels, Knives

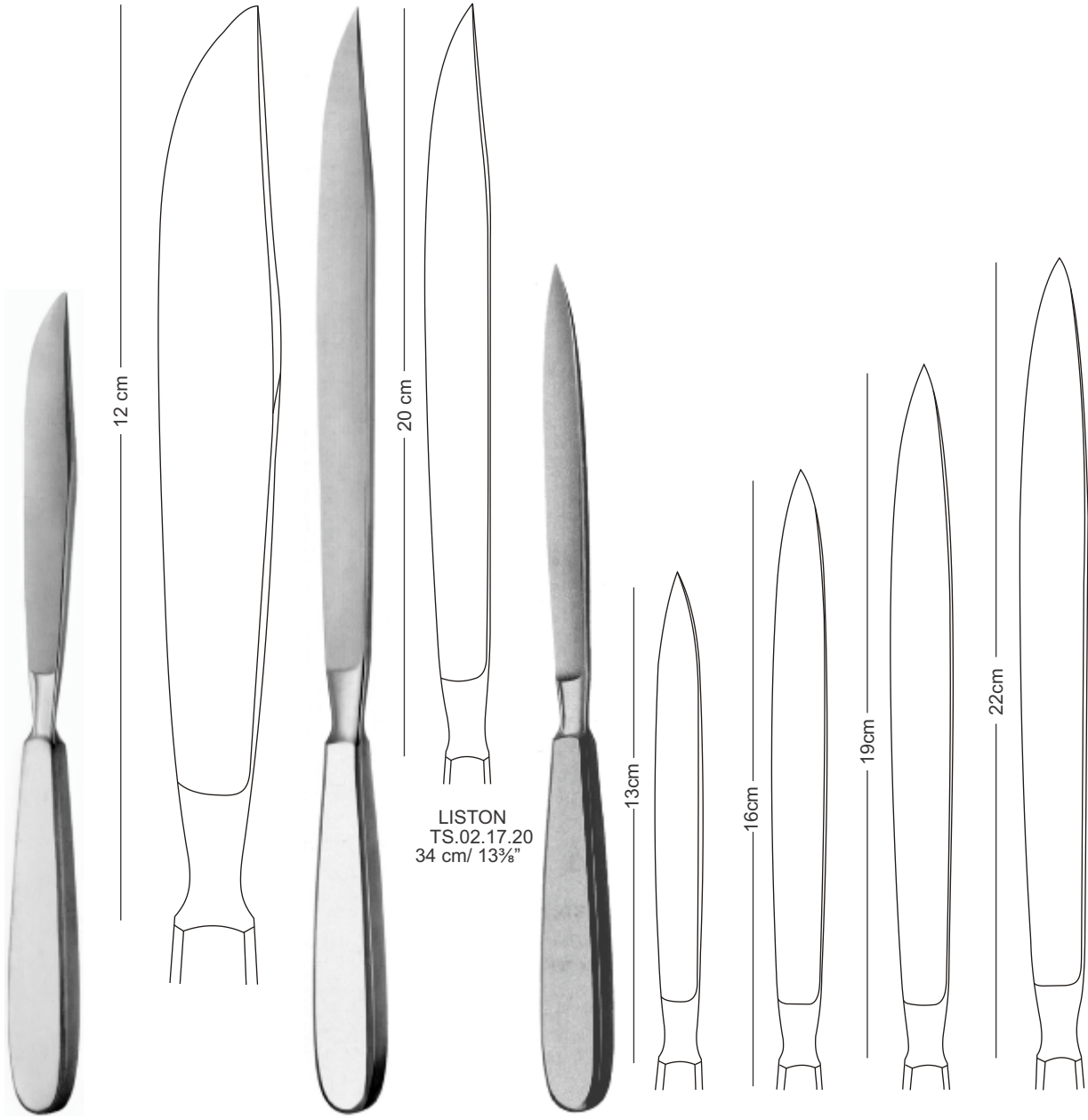

**LANGENBECK**  
 TS.02.17.12  
 24 cm / 9½"

**LISTON**  
 TS.02.17.20  
 34 cm / 13¾"

TS.02.17.26 26 cm / 10¼"    TS.02.17.29 29 cm / 11⅝"    TS.02.17.32 32 cm / 12½"    TS.02.17.35 35 cm / 13¾"

# Scalpels, Knives



LISTON  
TS.02.18.10  
23 cm/ 9"



LANGENBECK  
18 cm/ 7 1/8"

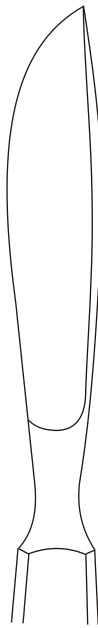

TS.02.19.01  
#1



TS.02.19.02  
#2



VIRCHOW  
TS.02.25.16 – 29 cm/ 11"  
TS.02.25.20 – 33 cm/ 13"  
TS.02.25.24 – 37 cm/ 14 1/2"



VAUGHN  
TS.02.30.12  
12.5 cm/ 5"



TS.02.31.13  
13 cm/ 5 1/8"



# Scalpels, Knives



HUMBY  
TS.02.30.30  
32 cm / 12½"  
Skin graft knife,  
without blades

Spare blade  
TS.02.30.31



WATSON  
TS.02.30.32  
30.5 cm / 12"  
Skin graft knife,  
without blades

# Dressing and Tissue Forceps



# Dressing and Tissue Forceps

4 x 5 teeth



STONE  
TS.02.11.15  
15 cm/ 6"

4 x 5 teeth

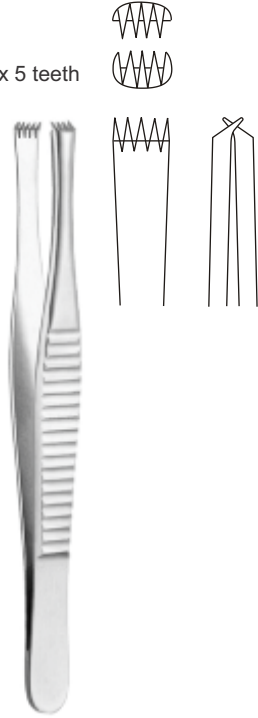

BEESON  
TS.02.11.16  
16 cm/ 6¼"

2 x 3 teeth

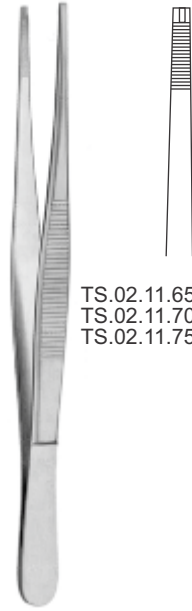

ADLERKREUTZ

- TS.02.11.65 15 cm/ 6"
- TS.02.11.70 20 cm/ 8"
- TS.02.11.75 25 cm/ 10"

4 x 5 teeth



ADLERKREUTZ

- TS.02.12.63 13 cm/ 5¼"
- TS.02.12.65 15 cm/ 6"
- TS.02.12.70 20 cm/ 8"
- TS.02.12.75 25 cm/ 10"

3 x 4 teeth



STILLE-BARRAYA

- TS.02.13.18 18 cm/ 7½"
- TS.02.13.20 20 cm/ 8"
- TS.02.13.25 25 cm/ 10"



ADSON  
TS.02.15.12  
12 cm/ 4¾"



ADSON "TC"  
TS.02.15.62  
12 cm/ 4¾"



ADSON "TC"  
TS.02.15.65  
15 cm/ 6"



# Dressing and Tissue Forceps

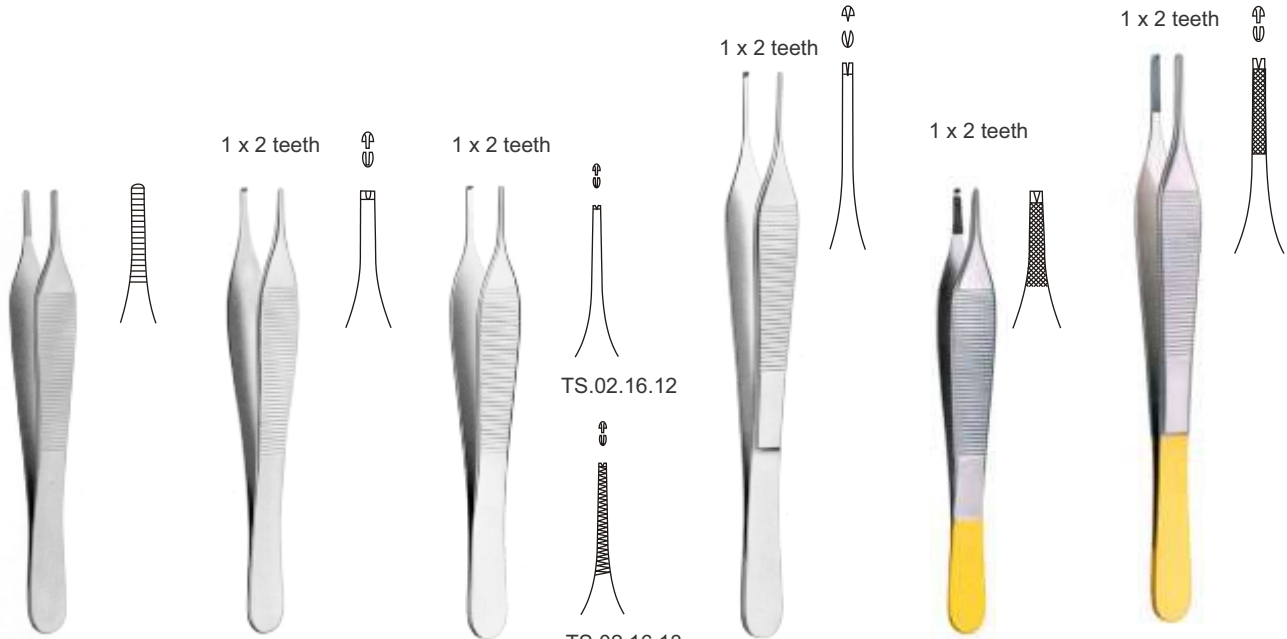

HUDSON-EWALD  
TS.02.16.01  
12 cm / 4¾"

HUDSON-EWALD  
TS.02.16.05  
12 cm / 4¾"

ADSON  
12 cm / 4¾"

TS.02.16.12

TS.02.16.13

ADSON  
TS.02.16.15  
15 cm / 6"

ADSON "TC"  
TS.02.16.62  
12 cm / 4¾"

ADSON "TC"  
TS.02.16.65  
15 cm / 6"

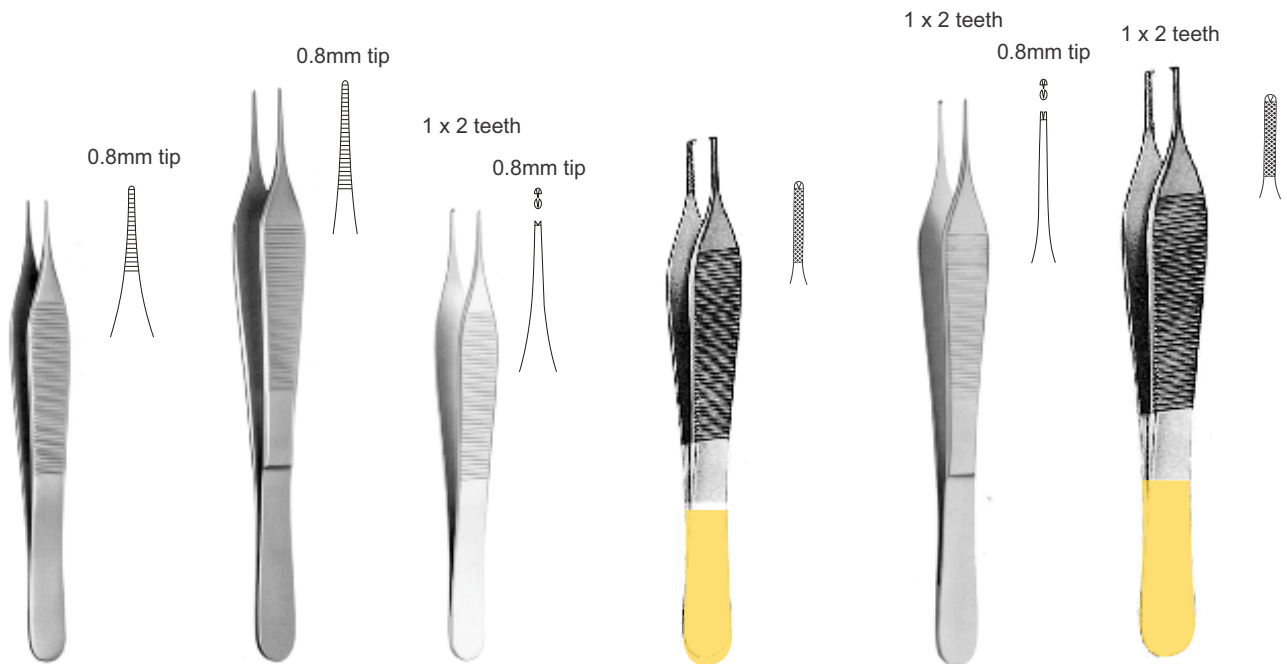

MICRO-ADSON  
TS.02.17.12  
12 cm / 4¾"

MICRO-ADSON  
TS.02.18.15  
15 cm / 6"

MICRO-ADSON  
TS.02.19.12  
12 cm / 4¾"

MICRO-ADSON "TC"  
TS.02.19.62  
12 cm / 4¾"

MICRO-ADSON  
TS.02.20.15  
15 cm / 6"

MICRO-ADSON "TC"  
TS.02.20.65  
15 cm / 6"

# Dressing and Tissue Forceps



Standard

TS.02.01.09  
9 cm / 3½"

TS.02.01.10  
10.5 cm / 4⅝"

TS.02.01.11  
11.5 cm / 4½"

TS.02.01.13  
13 cm / 5⅝"

TS.02.01.14  
14.5 cm / 5¾"

TS.02.01.15  
15 cm / 6"

TS.02.01.16  
16 cm / 6¼"

TS.02.01.18  
18 cm / 7⅞"

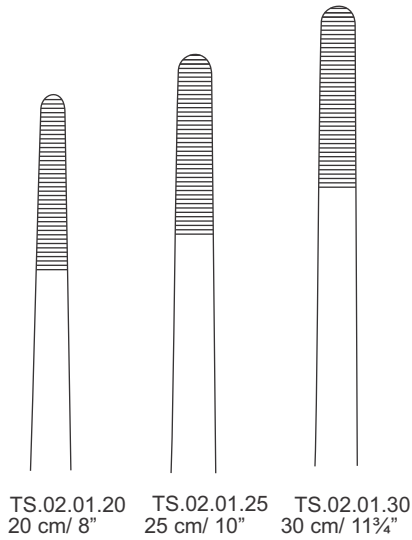

TS.02.01.20  
20 cm / 8"

TS.02.01.25  
25 cm / 10"

TS.02.01.30  
30 cm / 11¼"



"TC"

TS.02.01.64  
14.5 cm / 5¾"

TS.02.01.70  
20 cm / 8"

TS.02.01.68  
18 cm / 7⅞"

TS.02.01.75  
25 cm / 10"



medium width

TS.02.02.10 10.5 cm / 4⅝" TS.02.02.11 11.5 cm / 4½" TS.02.02.13 13 cm / 5" TS.02.02.14 14.5 cm / 5¾" TS.02.02.16 16 cm / 6¼" TS.02.02.18 18 cm / 7⅞" TS.02.02.20 20 cm / 8" TS.02.02.25 25 cm / 10" TS.02.02.30 30 cm / 11¼"



# Dressing and Tissue Forceps

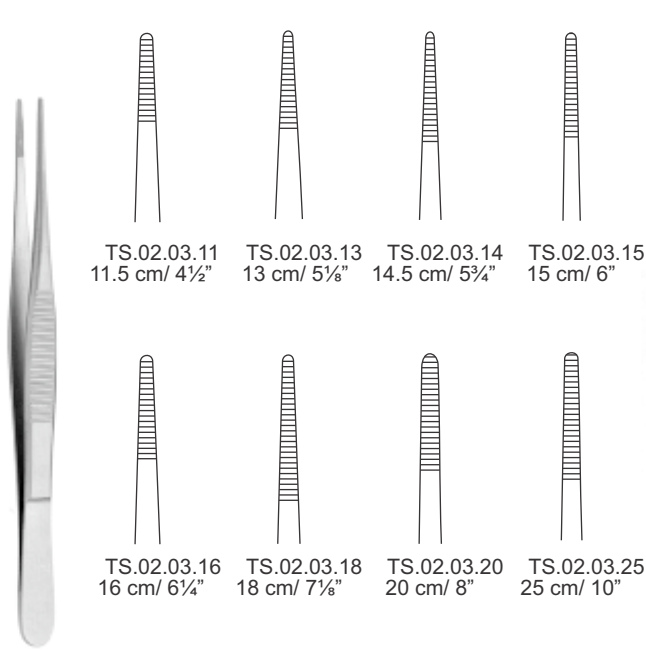

Slim

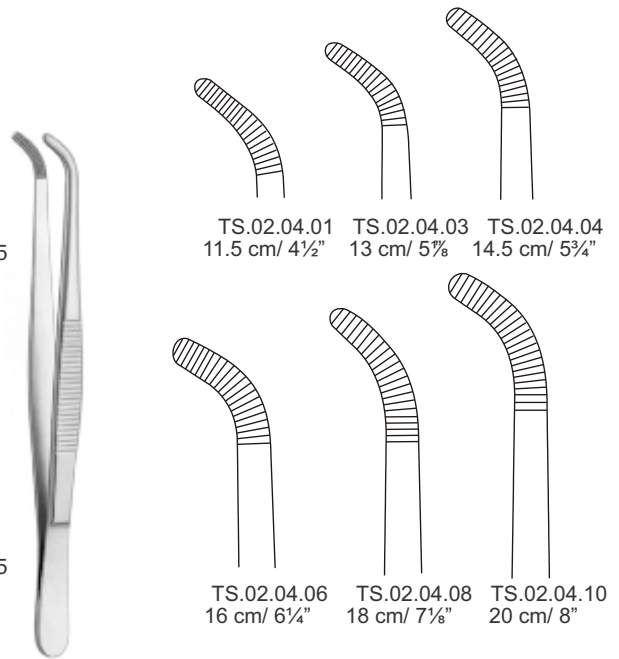

Standard

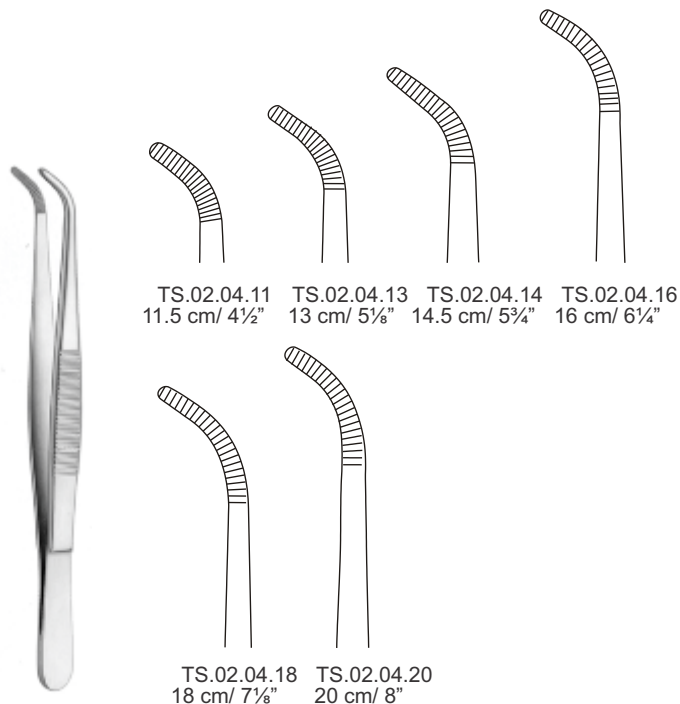

medium width

1 x 2 teeth

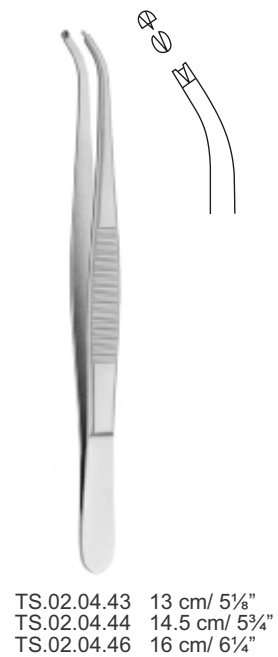

# Dressing and Tissue Forceps

1 x 2 teeth



Standard

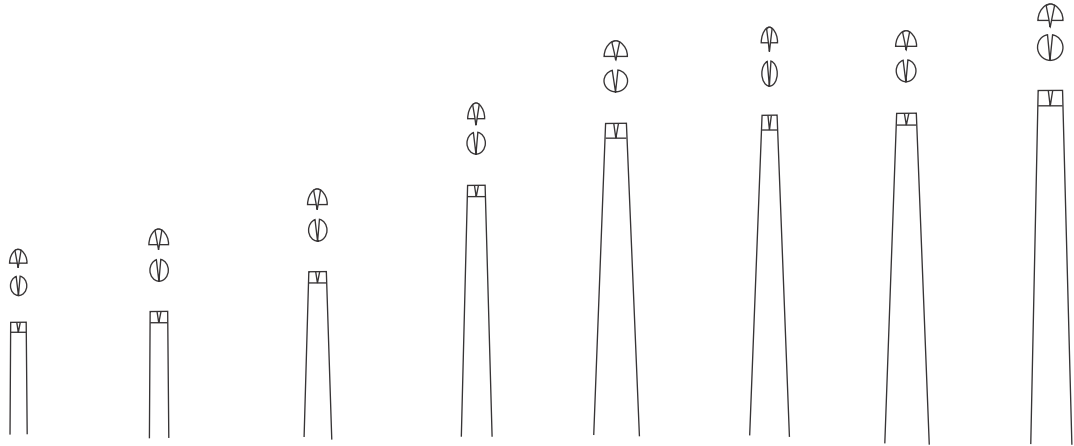

TS.02.05.09 9 cm / 3½"    TS.02.05.10 10.5 cm / 4⅛"    TS.02.05.11 11.5 cm / 4½"    TS.02.05.13 13 cm / 5⅛"    TS.02.05.14 14.5 cm / 5¾"    TS.02.05.15 15 cm / 6"    TS.02.05.16 16 cm / 6¼"    TS.02.05.18 18 cm / 7⅛"

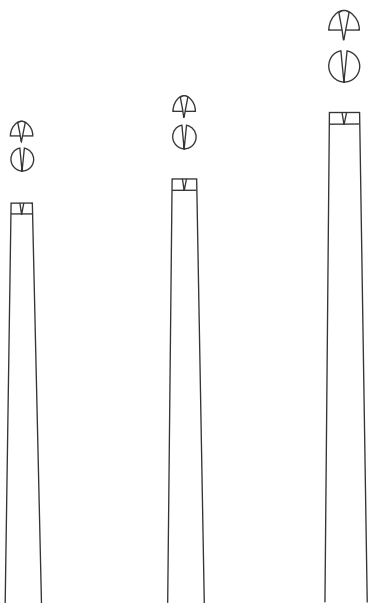

TS.02.05.20 20 cm / 8"    TS.02.05.25 25 cm / 10"    TS.02.05.30 30 cm / 11¾"

1 x 2 teeth



medium width

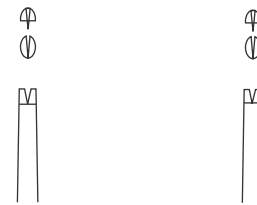

TS.02.06.11 11.5 cm / 4½"    TS.02.06.13 13 cm / 5⅛"

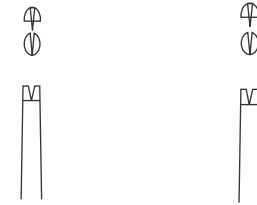

TS.02.06.14 14.5 cm / 5¾"    TS.02.06.16 16 cm / 6¼"

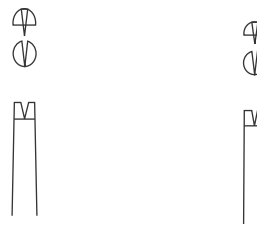

TS.02.06.18 18 cm / 7⅛"    TS.02.06.20 20 cm / 8"



TS.02.06.25 25 cm / 10"    TS.02.06.30 30 cm / 11¾"

# Dressing and Tissue Forceps

1 x 2 teeth

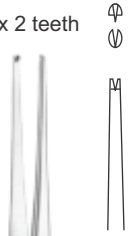

slim

TS.02.07.11  
11.5 cm / 4½"

TS.02.07.13  
13 cm / 5"

TS.02.07.14  
14.5 cm / 5¾"

TS.02.07.15  
15 cm / 6"



TS.02.07.16  
16 cm / 6¼"



TS.02.07.18  
18 cm / 7½"

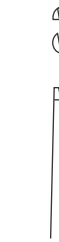

TS.02.07.20  
20 cm / 8"



TS.02.07.25  
25 cm / 10"

2 x 3 teeth



TS.02.08.13 13 cm / 5½"  
TS.02.08.14 14.5 cm / 5¾"  
TS.02.08.16 16 cm / 6¼"  
TS.02.08.18 18 cm / 7½"  
TS.02.08.20 20 cm / 8"  
TS.02.08.25 25 cm / 10"

3 x 4 teeth



TS.02.09.13 13 cm / 5½"  
TS.02.09.14 14.5 cm / 5¾"  
TS.02.09.16 16 cm / 6¼"  
TS.02.09.20 20 cm / 8"

4 x 5 teeth

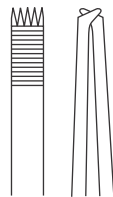

STILLE  
TS.02.10.13  
13 cm / 5½"

4 x 5 teeth



TS.02.10.14 14.5 cm / 5¾"  
TS.02.10.16 16 cm / 6¼"

5 x 6 teeth



LERCHE  
TS.02.10.15  
15 cm / 6"

# Dressing and Tissue Forceps

7 x 7 teeth



TS.02.21.12

9 x 9 teeth  
9 x 9 Zähne  
9 x 9 dientes  
9 x 9 dents  
9 x 9 denti



TS.02.21.13



ADSON-BROWN  
12 cm/ 4¾"

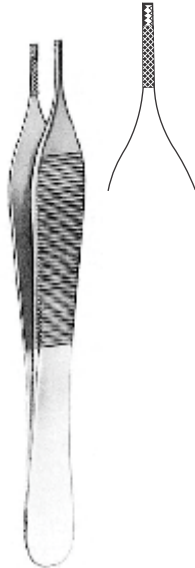

ADSON-BROWN "TC"  
TS.02.21.62  
12 cm/ 4¾"



DELACKI  
TS.02.21.72  
12 cm/ 4¾"

7 x 7 teeth



ADSON-BROWN  
TS.02.22.72  
12 cm/ 4¾"



1 x 2 teeth



TREVES  
TS.02.23.13  
13 cm/ 5½"

1 x 2 teeth



LANE  
TS.02.23.14 14 cm/ 5½"  
TS.02.23.20 20 cm/ 8"

1 x 2 teeth



TREVES  
TS.02.23.15  
15 cm/ 6"

2 x 3 teeth



ADSON-GRAEFE  
TS.02.23.82  
12 cm/ 4¾"



LANE  
TS.02.23.84 14 cm/ 5½"  
TS.02.23.90 20 cm/ 8"



IRIS  
10 cm/ 4"

TS.02.24.10 TS.02.25.20 TS.02.26.30  
straight slightly curved strong curved

# Dressing and Tissue Forceps

1 x 2 teeth



TS.02.27.10 TS.02.28.20 TS.02.29.30  
straight slightly curved strong curved

IRIS  
10 cm / 4"

SEMKEN serrated jaws



TS.02.30.12 TS.02.30.15  
12.5 cm / 5" 15 cm / 6"

SEMKEN

TS.02.31.22 TS.02.31.25  
12.5 cm / 5" 15 cm / 6"

1 x 2 teeth



TS.02.32.12 TS.02.32.15  
12.5 cm / 5" 15 cm / 6"

SEMKEN

TS.02.33.22 TS.02.33.25  
12.5 cm / 5" 15 cm / 6"

1 x 2 teeth

2 x 3 teeth



SEMKEN  
TS.02.34.32  
12.5 cm / 5"



"SELECT"  
serrated jaws

TS.02.34.51 11 cm / 4 1/4"

TS.02.34.53 13 cm / 5 1/8"

TS.02.34.58 18 cm / 7 1/8"

TS.02.34.60 20 cm / 8"

1 x 2 teeth



SEMKEN

TS.02.34.55 15 cm / 6"

TS.02.34.61 11 cm / 4 1/4"

TS.02.34.68 18 cm / 7 1/8"

"SELECT"

SEMKEN

TS.02.34.63 13 cm / 5 1/8"

TS.02.34.65 15 cm / 6"

TS.02.34.70 20 cm / 8"

# Dressing and Tissue Forceps



MCINDOE  
TS.02.35.15  
15 cm / 6"



MCINDOE "TC"  
TS.02.35.65  
15 cm / 6"



1 x 2 teeth



GILLIES  
TS.02.36.85  
15 cm / 6"



GILLIES "TC"  
TS.02.36.95  
15 cm / 6"



WAUGH  
TS.02.37.15  
15 cm / 6"



WAUGH  
TS.02.37.20  
20 cm / 8"



1 x 2 teeth



WAUGH  
TS.02.38.15  
15 cm / 6"



WAUGH

TS.02.38.18  
18 cm / 7 1/8"



TS.02.38.20  
20 cm / 8"

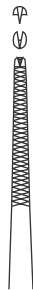

1 x 2 teeth

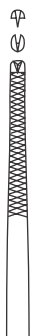

TS.02.38.25  
25 cm / 10"



TS.02.38.30  
30.5 cm / 12"

1 x 2 teeth



WAUGH "TC"  
TS.02.38.65 15 cm / 6"  
TS.02.38.70 20 cm / 8"



POTTS-SMITH  
delicate

TS.02.39.18  
18 cm / 7 1/8"



TS.02.39.20  
20 cm / 8"



TS.02.39.25  
25 cm / 10"



# Dressing and Tissue Forceps



TS.02.39.65 15 cm/ 6"  
TS.02.39.68 18 cm/ 7 1/8"  
TS.02.39.70 20 cm/ 8"  
TS.02.39.73 23 cm/ 9"  
TS.02.39.75 25 cm/ 10"

**POTTS-SMITH**  
"TC"  
standard



TS.02.39.85 14.5 cm/ 5 3/4"  
TS.02.39.88 18 cm/ 7 1/8"  
TS.02.39.93 23 cm/ 9"

**POTTS-SMITH**  
"TC"  
extremely delicate



TS.02.40.18  
18 cm/ 7 1/8"

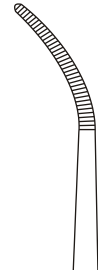

TS.02.40.20  
20 cm/ 8"

**BROPHY**  
serrated jaws

1 x 2 teeth  
1 x 2 Zähne  
1 x 2 dientes  
1 x 2 dents  
1 x 2 denti



TS.02.41.18  
18 cm/ 7 1/8"



TS.02.41.20  
20 cm/ 8"



TS.02.41.25  
25 cm/ 10"

**POTTS-SMITH**  
delicate

1 x 2 teeth  
1 x 2 Zähne  
1 x 2 dientes  
1 x 2 dents  
1 x 2 denti



TS.02.42.18  
18 cm/ 7 1/8"

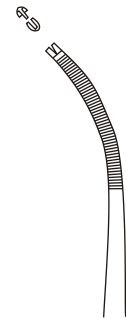

TS.02.42.20  
20 cm/ 8"

**BROPHY**

# Dressing and Tissue Forceps



TS.02.42.23 13 cm/ 5 $\frac{1}{8}$ "  
 TS.02.42.25 15 cm/ 6"  
 TS.02.42.27 17 cm/ 6 $\frac{3}{4}$ "  
 TS.02.42.30 20 cm/ 8"

swedish pattern



BLANK

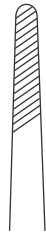

TS.02.42.33 13 cm/ 5 $\frac{1}{8}$ "

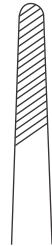

TS.02.42.34 14.5 cm/ 5 $\frac{3}{4}$ "



TS.02.42.36 16 cm/ 6 $\frac{1}{4}$ "



TS.02.42.40  
20 cm/ 8"

swedish pattern

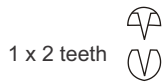

TS.02.42.50  
20 cm/ 8"  
swedish pattern



DEBAKEY "AT"

1.5 mm

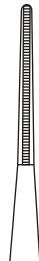

TS.02.43.15 15 cm/ 6"

1.5 mm

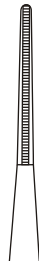

TS.02.43.16 16 cm/ 6 $\frac{1}{4}$ "

1.5 mm

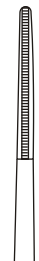

TS.02.43.19 20 cm/ 8"

1.5 mm

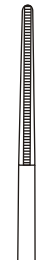

TS.02.43.24 24 cm/ 9 $\frac{1}{2}$ "

1.5 mm

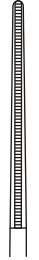

TS.02.43.30 30 cm/ 11 $\frac{3}{4}$ "

Vascular forceps



DEBAKEY "AT"

2.0 mm



TS.02.44.15 15 cm/ 6"

2.0 mm



TS.02.44.19 20 cm/ 8"

2.0 mm



TS.02.44.24 24 cm/ 9 $\frac{1}{2}$ "

2.0 mm



TS.02.44.30 30 cm/ 11 $\frac{3}{4}$ "



# Dressing and Tissue Forceps

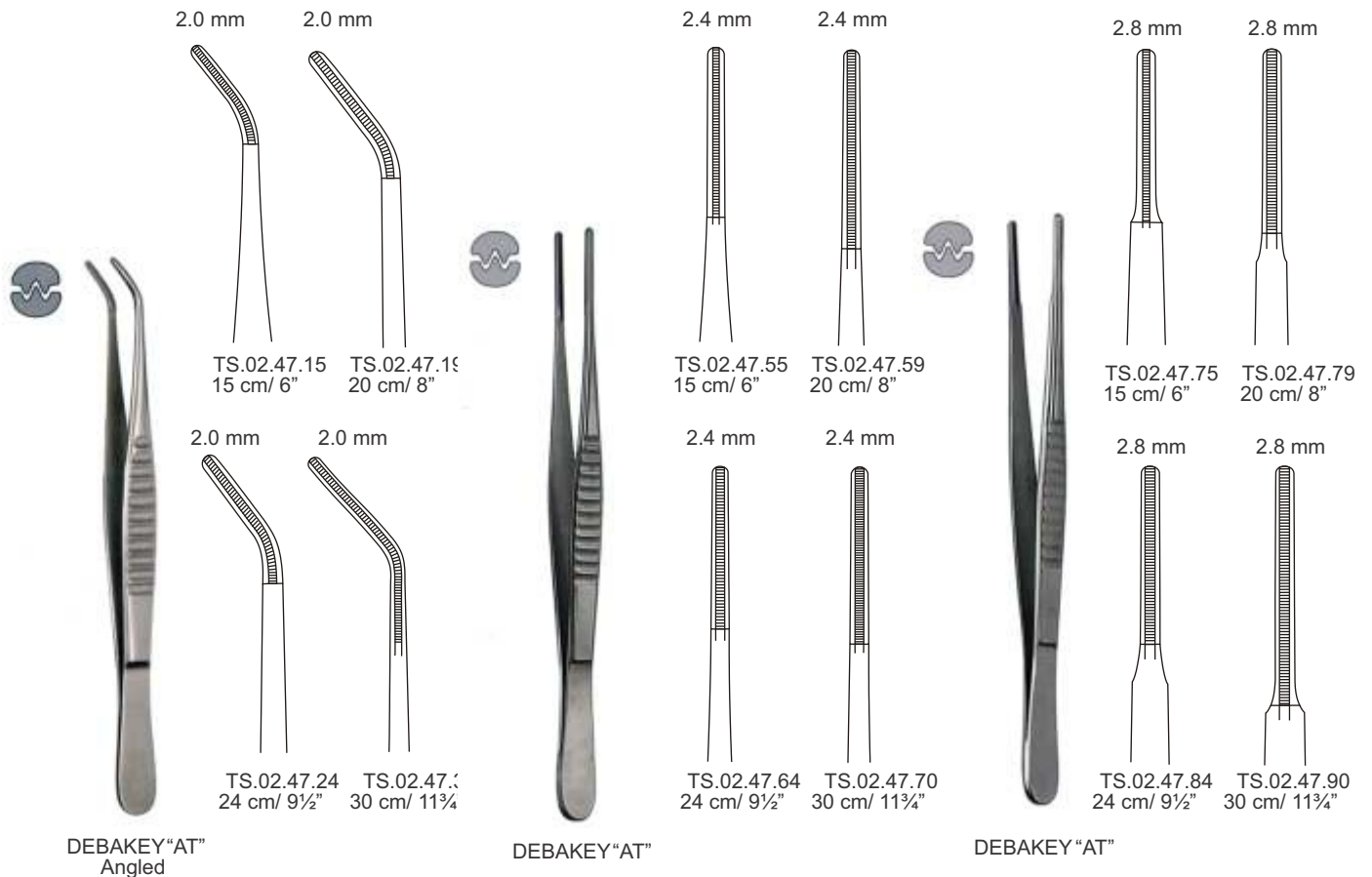
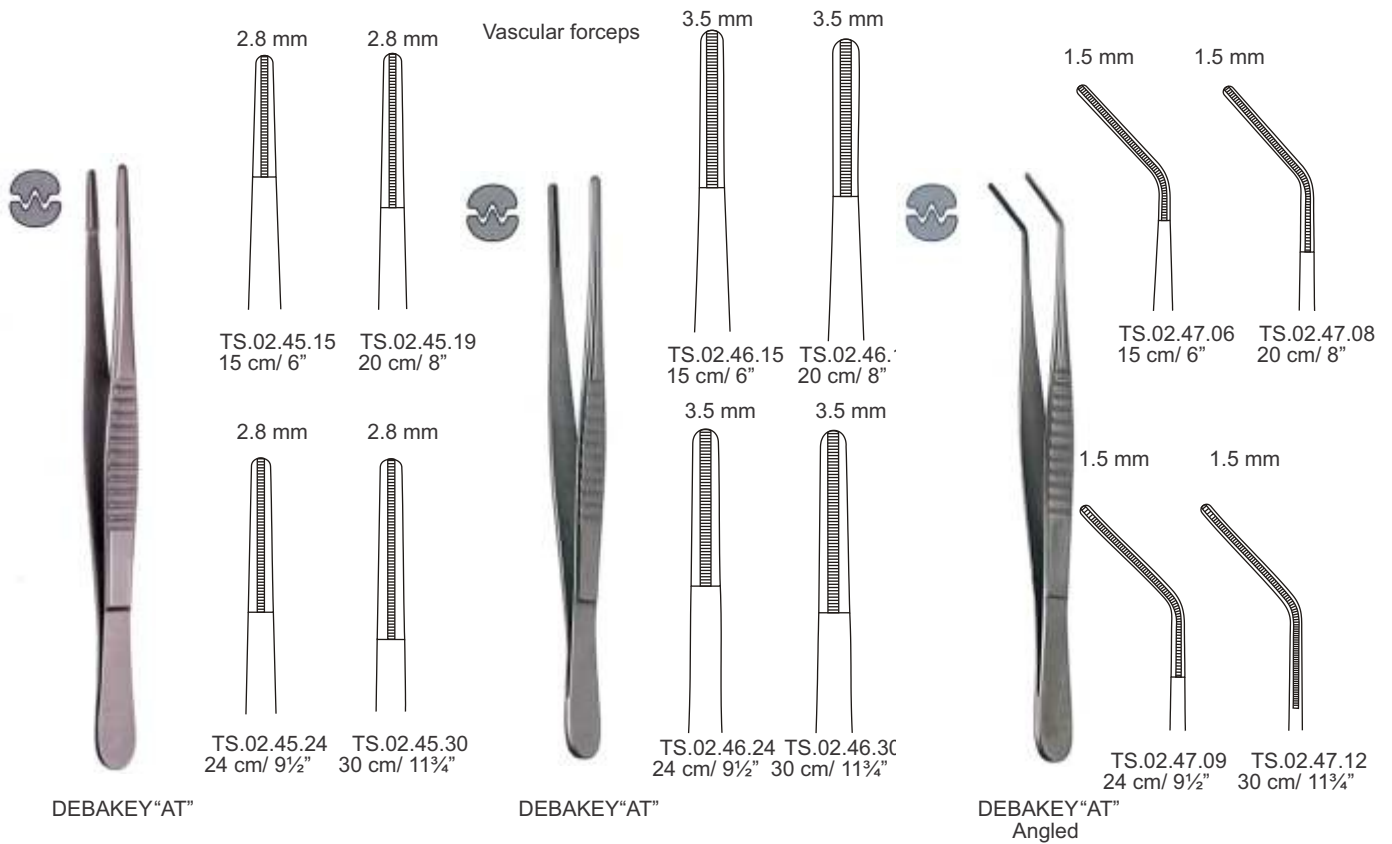

# Dressing and Tissue Forceps

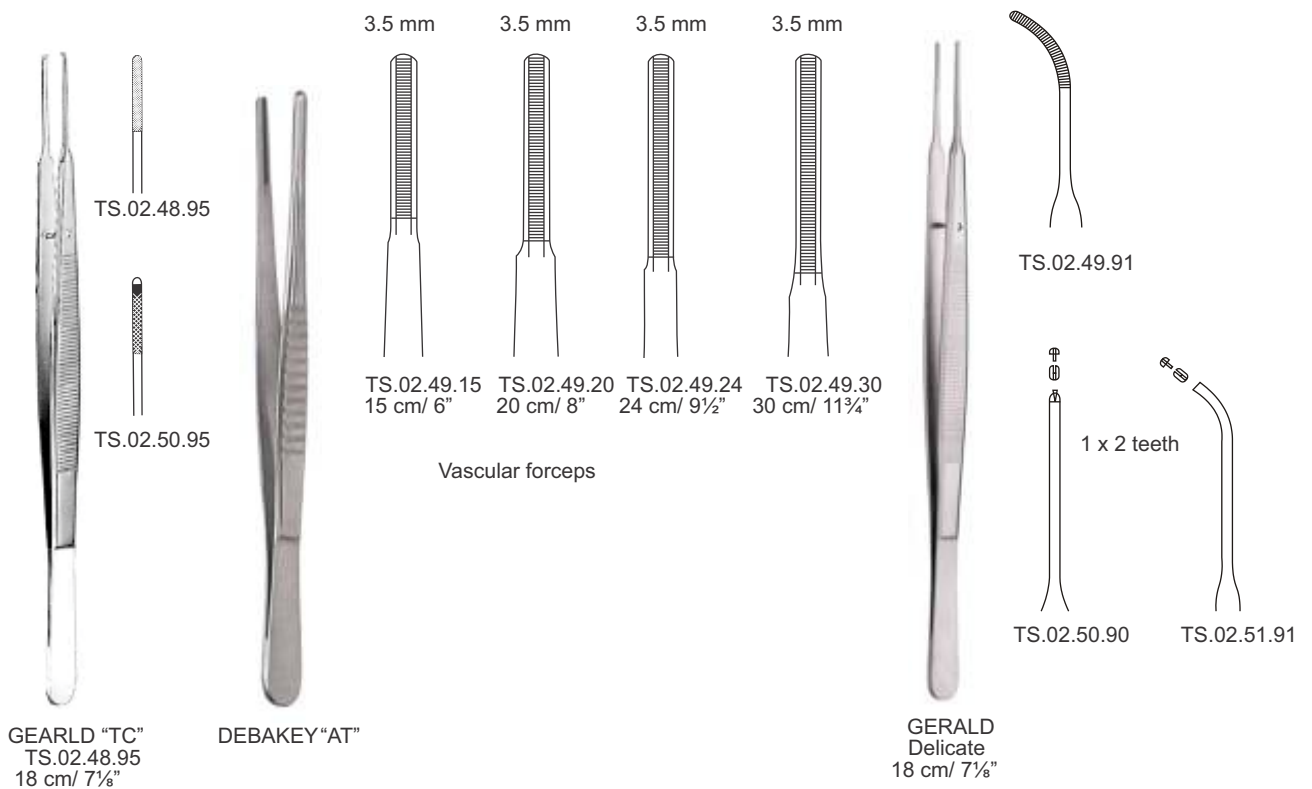
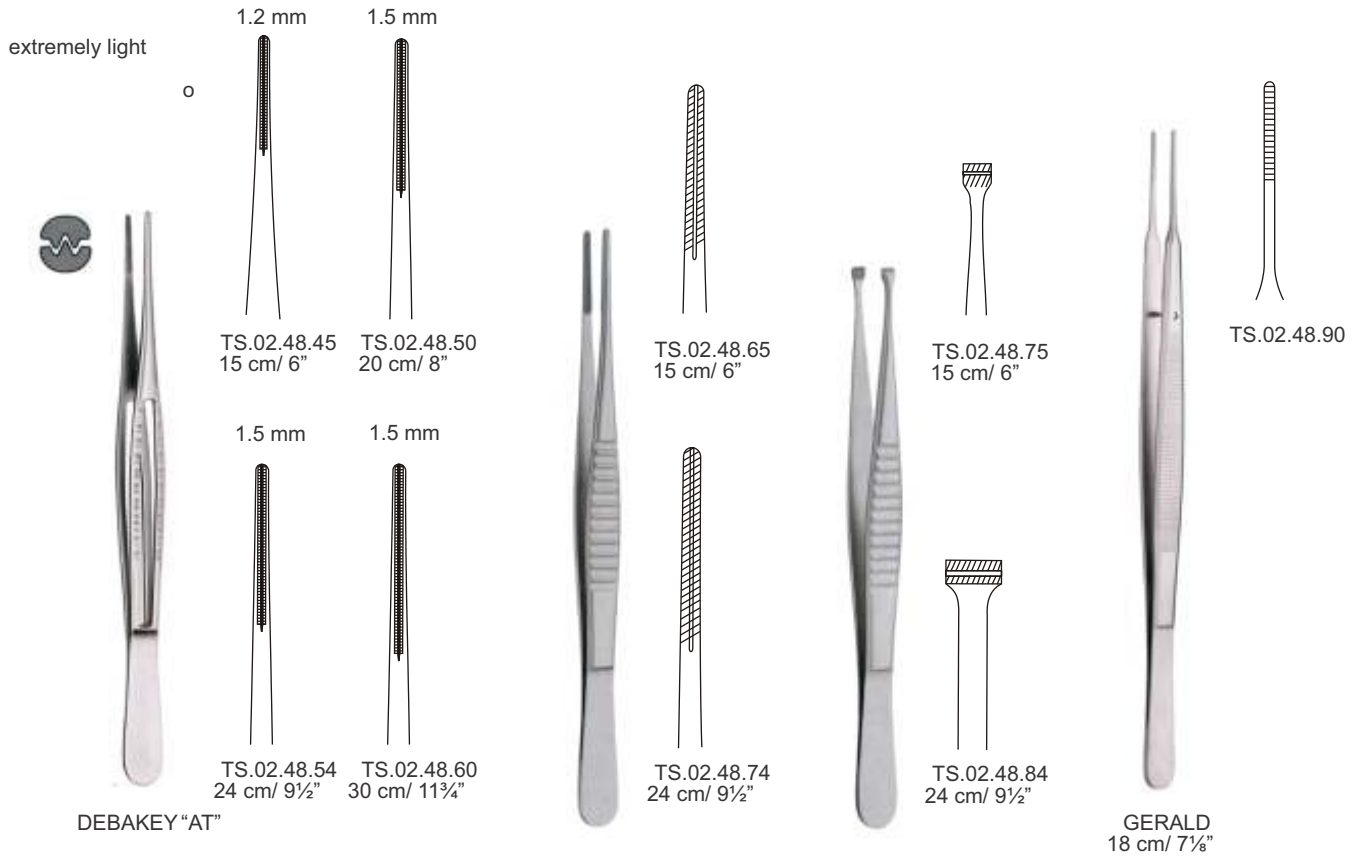

# Dressing and Tissue Forceps

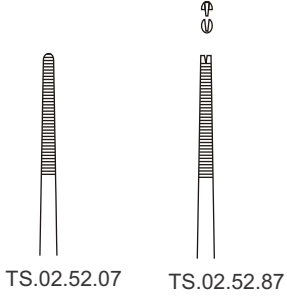

CUSHING  
18 cm / 7 1/8"



with dissector end

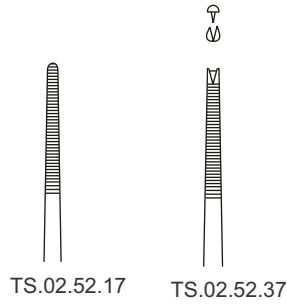

CUSHING  
18 cm / 7 1/8"



with dissector end

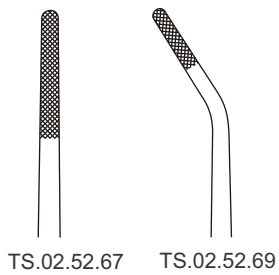

CUSHING "TC"  
18 cm / 7 1/8"



with dissector end

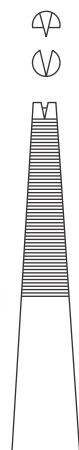

BONNEY  
TS.02.52.91  
18 cm / 7 1/8"

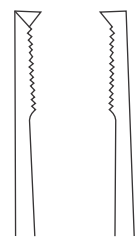

FERRIS-SMITH  
18 cm / 7 1/8"

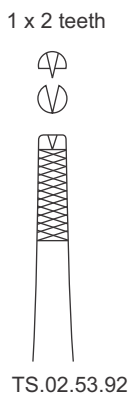

2 x 3 teeth

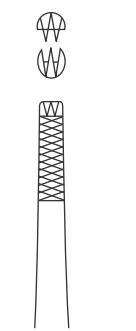

# Dressing and Tissue Forceps

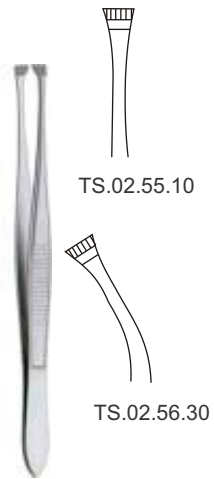

TS.02.55.10



TS.02.56.30

GRAEFE  
11 cm / 4 1/4"

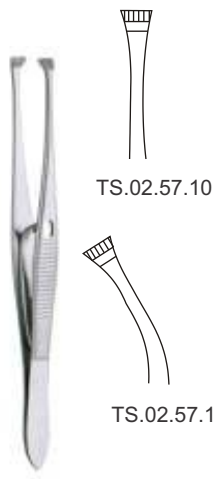

TS.02.57.10

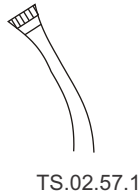

TS.02.57.11

GRAEFE  
11 cm / 4 1/4"



CUSHING (TAYLOR)  
TS.02.55.18 18.5 cm / 7 1/4"  
TS.02.55.19 19.5 cm / 7 3/4"



with dissector end



CUSHING (TAYLOR)  
TS.02.55.28 18.5 cm / 7 1/4"



GERALD  
TS.02.55.39  
19 cm / 7 1/2"



GERALD  
TS.02.55.49  
19 cm / 7 1/2"



GREEN  
10 cm / 4"

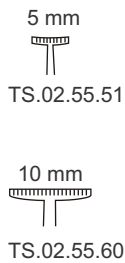

5 mm  
TS.02.55.51

10 mm  
TS.02.55.60



GERALD  
TS.02.55.59  
19 cm / 7 1/2"



CUSHING (TAYLOR) "TC"  
TS.02.55.68  
18.5 cm / 7 1/4"

# Dressing and Tissue Forceps



BROWN

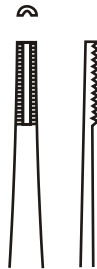

TS.02.57.15  
15 cm / 6"

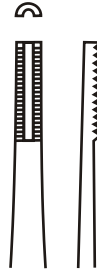

TS.02.57.20  
20 cm / 8"



TS.02.57.25  
25 cm / 10"



DURANTE  
TS.02.57.44 14.5 cm / 5"  
TS.02.57.46 16 cm / 6 1/2"  
TS.02.57.50 20 cm / 8"



TUTTLE  
TS.02.58.18 18 cm / 7 1/8"  
TS.02.58.23 23 cm / 9"



RUSS. MOD

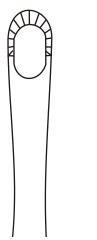

TS.02.59.15  
15 cm / 6"

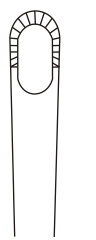

TS.02.59.20  
20 cm / 8"

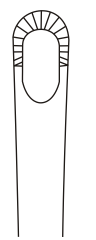

TS.02.59.25  
25 cm / 10"



MAYO  
TS.02.59.33  
23 cm / 9"



WANGENSTEEN  
TS.02.59.45 15 cm / 6"  
TS.02.59.53 23 cm / 9"  
TS.02.59.55 25 cm / 10"



WANGENSTEEN "TC"  
TS.02.59.65 15 cm / 6"  
TS.02.59.73 23 cm / 9"  
TS.02.59.74 25 cm / 10"



# Dressing and Tissue Forceps

**DUVAL**  
14.5 cm / 5¾"

8 mm  
TS.02.60.08 # 1

10 mm  
TS.02.60.10 # 2

**NELSON**  
TS.02.60.15 15 cm / 6"  
TS.02.60.23 23 cm / 9"

TS.02.60.26 16 cm / 6¼"

TS.02.60.36 16 cm / 6¼"

14 mm  
TS.02.61.14 # 1

18 mm  
TS.02.61.18 # 2

27 mm  
TS.02.61.27 # 3

TS.02.62.14

TS.02.63.14

**COLLIN-DUVAL**  
21 cm / 8¼"

**LUCAE**  
14 cm / 5½"

**LUCAE**  
TS.02.66.14  
14 cm / 5½"

1 x 2 teeth

Φ

# Dressing and Tissue Forceps

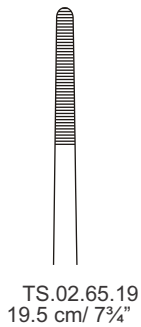
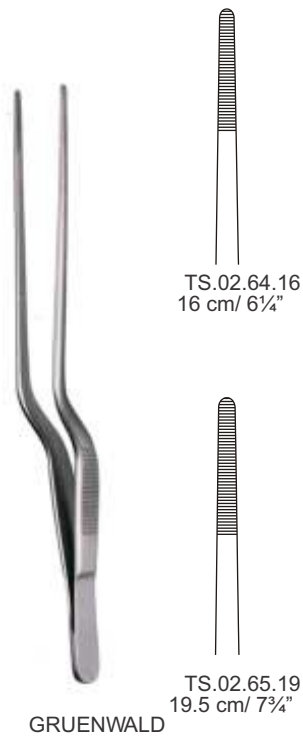

1 x 2 teeth

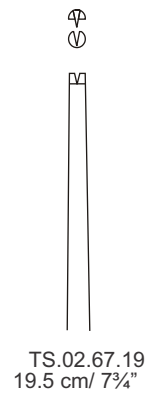

# Dressing and Tissue Forceps

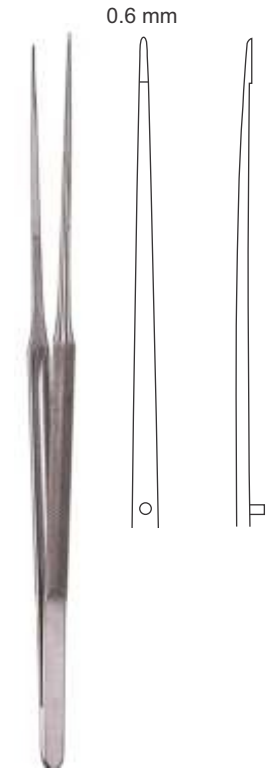

TS.02.71.84  
23 cm / 9"



TROELTSCH  
TS.02.72.73  
13 cm / 5 1/8"



TROELTSCH (WILDE)  
TS.02.74.11  
11 cm / 4 1/4"



TROELTSCH (WILDE)  
TS.02.74.13  
13 cm / 5 1/8"



TROELTSCH  
TS.02.75.14  
14 cm / 5 1/2"



TS.02.76.10

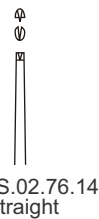

TS.02.76.14  
straight



TS.02.76.08  
8 cm / 3"

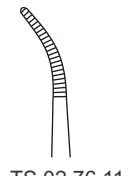

TS.02.76.11

1 x 2 teeth

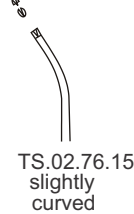

TS.02.76.15  
slightly curved

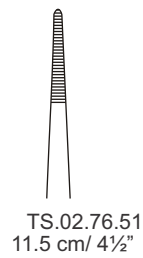

TS.02.76.51  
11.5 cm / 4 1/2"



TS.02.77.40  
10.5 cm / 4 1/8"



TS.02.76.09  
9 cm / 3 1/2"

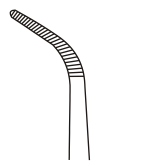

TS.02.76.13



TS.02.76.16  
strong curved

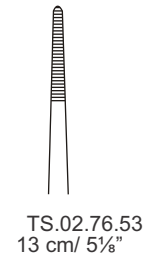

TS.02.76.53  
13 cm / 5 1/8"



TS.02.77.41  
11.5 cm / 4 1/2"

KRONECKER

10 cm / 4"

10 cm / 4"

delicate

delicate



# Dressing and Tissue Forceps

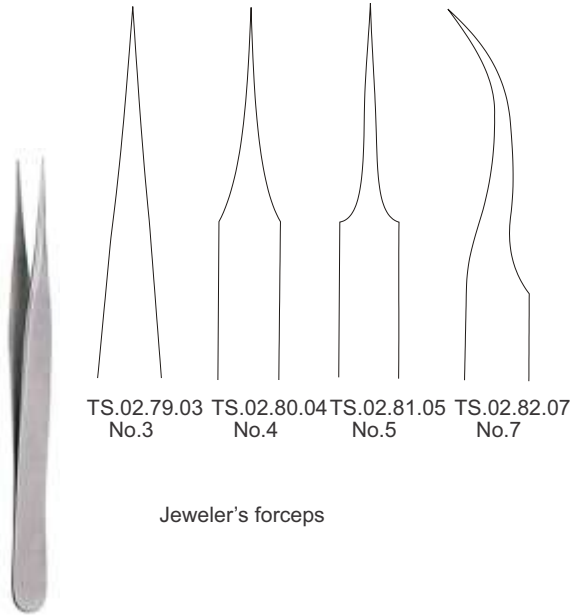

TS.02.79.03 No.3    TS.02.80.04 No.4    TS.02.81.05 No.5    TS.02.82.07 No.7

Jeweler's forceps

11.5 cm / 4½"

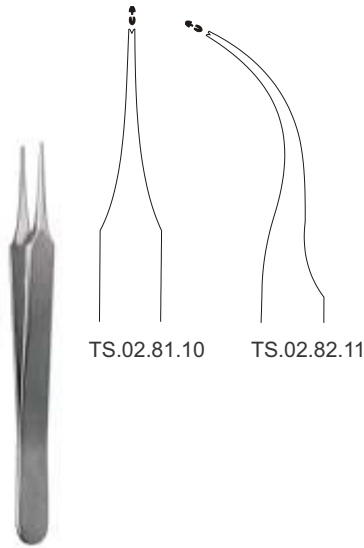

TS.02.81.10    TS.02.82.11

11.5 cm / 4½"

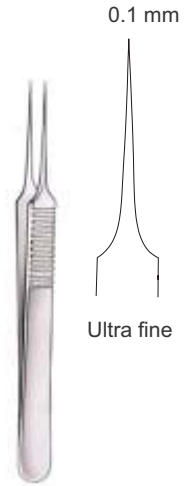

KOSHIMA  
TS.02.83.51  
11 cm / 4¼"



PEET  
TS.02.85.11  
11.5 cm / 4½"

ARTHUR  
TS.02.86.04  
14 cm / 5½"

STIEGLITZ  
(WILLIAMS)

TS.02.87.14  
14 cm / 5½"

TS.02.88.24  
13 cm / 5¼"

TS.02.88.34  
12 cm / 4¾"

RALK (VIRTUS)  
14 cm / 5½"

TS.02.89.14

TS.02.89.24

# Dressing and Tissue Forceps

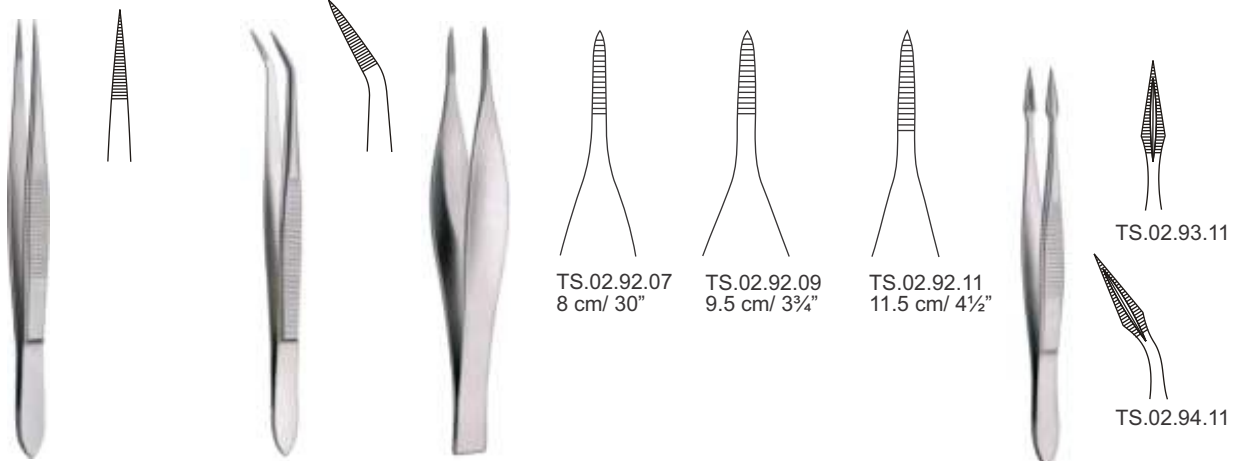

**SPLINTER**  
 TS.02.90.08 8 cm/ 3"  
 TS.02.90.09 9 cm/ 3½"  
 TS.02.90.10 10.5 cm/ 4¼"  
 TS.02.90.11 11.5 cm/ 4½"

**SPLINTER**  
 TS.02.91.08 8 cm/ 3"  
 TS.02.91.09 9 cm/ 3½"  
 TS.02.91.10 10 cm/ 4"  
 TS.02.91.11 11 cm/ 4¼"

TS.02.92.07 8 cm/ 30"  
 TS.02.92.09 9.5 cm/ 3¾"  
 TS.02.92.11 11.5 cm/ 4½"

TS.02.93.11  
 TS.02.94.11

**HUNTER**  
11 cm/ 4¼"

**FEILCHENFELD**

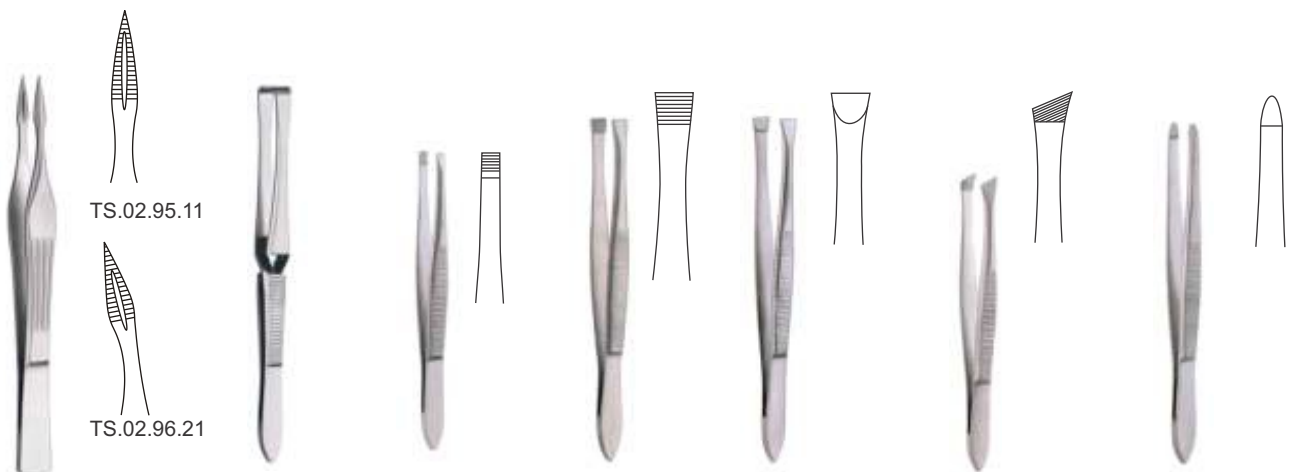

TS.02.95.11  
 TS.02.96.21

**WALTER**  
11 cm/ 4¼"

TS.02.97.10  
10 cm/ 4"  
Tick forceps

**DOUGLAS**  
TS.02.98.08  
8 cm/ 3"

TS.02.99.09  
9 cm/ 3½"

**LITTAUER**  
TS.02.99.19  
9 cm/ 3½"

**BERGH**  
TS.02.99.28  
8 cm/ 3"

**ZIEGLER**  
TS.02.99.29  
9 cm/ 3½"

# Dressing and Tissue Forceps



TS.03.98.40  
19.5 cm / 7 3/4"



TS.03.99.59  
19.5 cm / 7 3/4"



TS.03.100.60  
19.5 cm / 7 3/4"



18.5 cm / 7 1/4"

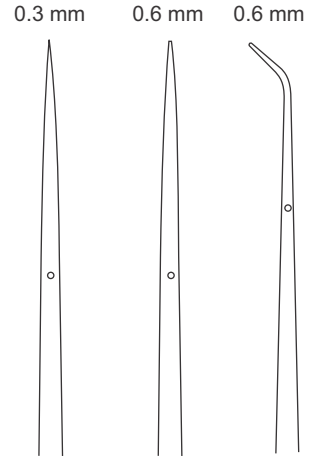

TS.03.101.40 TS.03.101.42 TS.03.101.43



TS.03.101.60  
19 cm / 7 1/2"



BEER  
TS.03.102.06 6 cm / 2 3/8"  
TS.03.102.09 8 cm / 3"



BEER  
TS.03.102.07  
8 cm / 3"

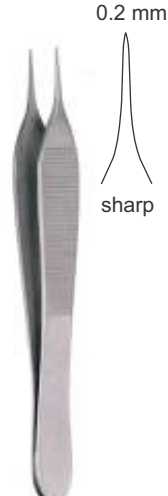

JACOBSON-ADSON  
TS.03.102.12  
12 cm / 4 3/4"



JACOBSON-ADSON  
(KOSHIMA)  
TS.03.102.42  
12 cm / 4 3/4"

# Dressing and Tissue Forceps



0.3 mm  
sharp

JACOBSON-ADSON  
TS.03.103.15  
15 cm / 6"



JACOBSON

0.4 mm



TS.03.104.11  
11 cm / 4<sup>3</sup>/<sub>8</sub>"  
sharp

0.4 mm



TS.03.104.15  
15 cm / 6"  
sharp

0.5 mm



TS.03.104.18  
18 cm / 7<sup>1</sup>/<sub>8</sub>"  
sharp



BARRAQUER  
TS.03.105.10  
10.5 cm / 4<sup>1</sup>/<sub>8</sub>"



GRADLE  
TS.03.105.11  
10.5 cm / 4<sup>1</sup>/<sub>8</sub>"



TS.03.105.19  
19.5 cm / 7<sup>3</sup>/<sub>4</sub>"



0.8 mm  
TS.03.105.50

1.2 mm  
TS.03.105.51

16.5 cm / 6<sup>1</sup>/<sub>2</sub>"



TS.03.106.20  
19.5 cm / 7<sup>3</sup>/<sub>4</sub>"



TS.03.106.52  
19 cm / 7<sup>1</sup>/<sub>2</sub>"

1.0 mm



CILIA  
TS.03.107.11  
10.5 cm / 4<sup>1</sup>/<sub>8</sub>"



MICRO 2000  
TS.03.108.13  
12.5 cm / 5"

0.2 mm



MICRO 2000  
TS.03.109.13  
12.5 cm / 5"

0.3 mm

# Dressing and Tissue Forceps

0.3 mm



MICRO 2000  
TS.03.110.13  
12.5 cm / 5"

0.1 mm



MICRO 2000  
TS.03.111.13  
13.5 cm / 5 1/4"

0.2 mm

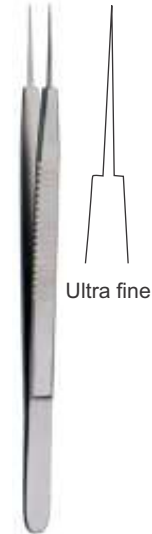

MICRO 2000  
(KOSHIMA)  
TS.03.111.14  
14 cm / 5 1/2"

0.3 mm



MICRO 2000  
TS.03.112.14  
14 cm / 5 1/2"

0.2 mm



MICRO 2000  
TS.03.114.11  
10.5 cm / 4 1/8"

0.3 mm



MICRO 2000  
TS.03.115.11  
10.5 cm / 4 1/8"

0.2 mm



TS.03.115.02  
sharp

0.3 mm



TS.03.115.03  
blunt

0.2 mm



MICRO 2000  
TS.03.116.12  
11.5 cm / 4 1/2"

0.3 mm



MICRO 2000  
TS.03.117.12  
11.5 cm / 4 1/2"

0.2 mm



MICRO 2000  
TS.03.118.11  
10.5 cm / 4 1/8"

0.3 mm



MICRO 2000  
TS.03.119.11  
10.5 cm / 4 1/8"

0.3 mm



MICRO 2000  
TS.03.120.11  
11.5 cm / 4 1/2"

0.2 mm



TS.03.116.02  
sharp

0.3 mm



TS.03.116.03  
blunt

MICRO 2000  
12 cm / 4 3/4"

# Dressing and Tissue Forceps



ADSON  
12 cm/ 4¾"



TS.03.150.12



ADSON  
12 cm/ 4¾"

1 x 2 teeth



TS.03.152.12



TS.03.154.15  
15 cm/ 6"

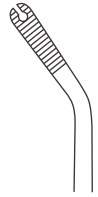

MICRO 2000  
14 cm/ 5½"

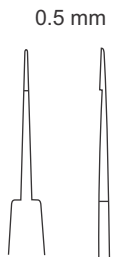

TS.03.165.05

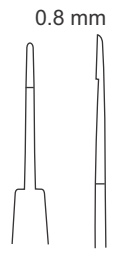

TS.03.165.08



AUSTIN  
TS.03.166.08  
18 cm/ 7⅛"

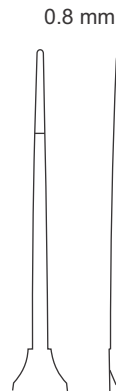

MICRO 2000  
12 cm/ 4¾"

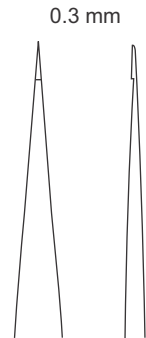

TS.03.167.03

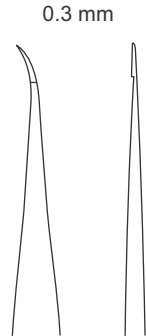

TS.03.168.03

# Dressing and Tissue Forceps



12 cm/ 4¾"  
15 cm/ 6"  
18 cm/ 7¼"



0.3 mm  
TS.03.170.12  
TS.03.170.15  
TS.03.170.18



0.3 mm  
TS.03.171.12  
TS.03.171.15  
TS.03.171.18



0.3 mm  
TS.03.172.12  
TS.03.172.15  
TS.03.172.18



0.3 mm  
TS.03.173.12  
TS.03.173.15  
TS.03.173.18



TS.03.175.23  
23 cm/ 9"



0.6 mm



# Sponge Forceps



Sponge Forceps



# Sponge Forceps



LISTER

TS.03.01.13  
13 cm / 5 1/8"



TS.03.01.15  
15 cm / 6"



TS.03.01.18  
18 cm / 7 1/8"



TS.03.03.17  
17.5 cm / 7"



MAIER  
26 cm / 10 1/4"

TS.03.07.26



TS.03.08.:



MAIER  
26 cm / 10 1/4"

TS.03.09.26



TS.03.10.26

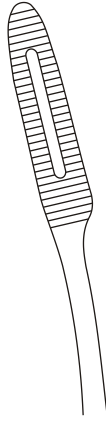

# Sponge Forceps



GROSS-MAIER

TS.03.11.20 20 cm/ 8"	TS.03.12.20
TS.03.11.22 22 cm/ 8¾"	TS.03.12.22
TS.03.13.26 26 cm/ 10¼"	TS.03.14.26

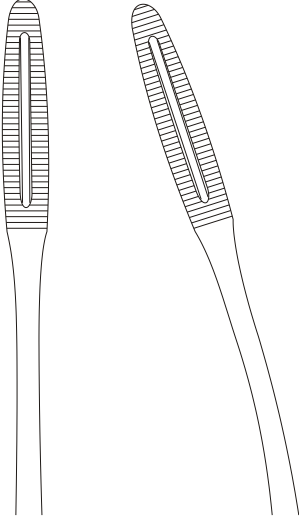

PELKMANN  
25 cm/ 10"

TS.03.15.25      TS.03.16.25

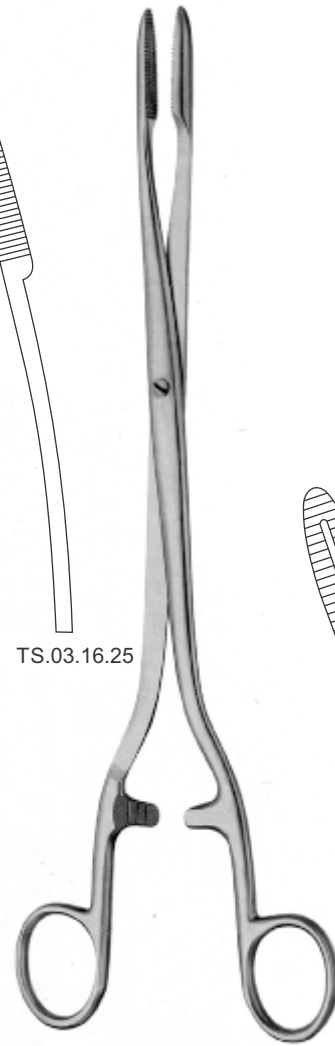
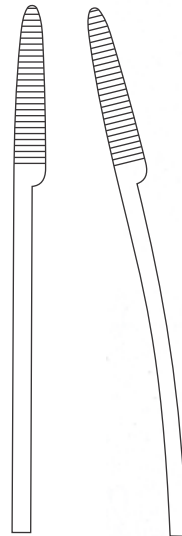

SIMS-MAIER  
28 cm/ 11"

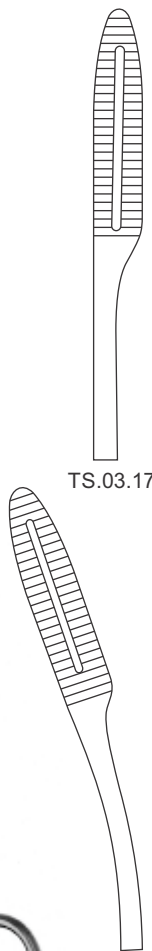

TS.03.17.28

TS.03.18.28



GROSS-MAIER

TS.03.19.20 20 cm/ 8"	TS.03.20.20
TS.03.29.26 26 cm/ 10¼"	TS.03.30.26

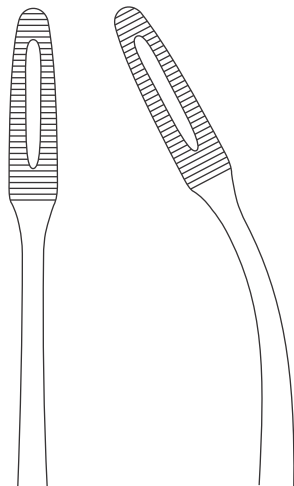

# Sponge Forceps

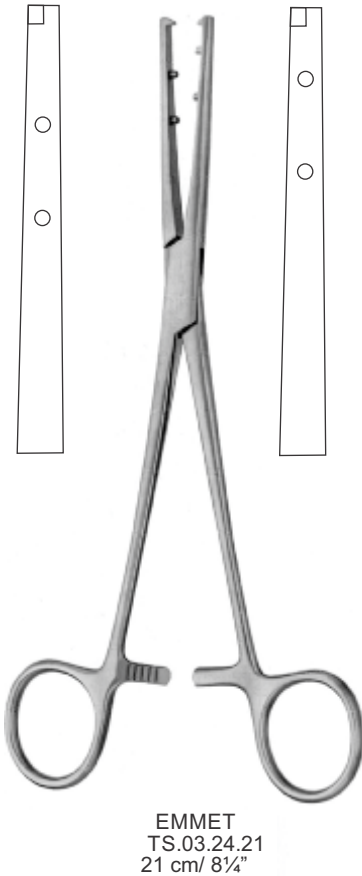
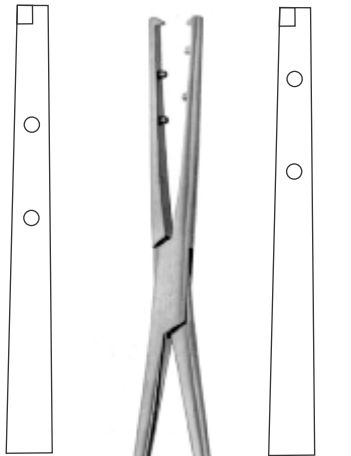
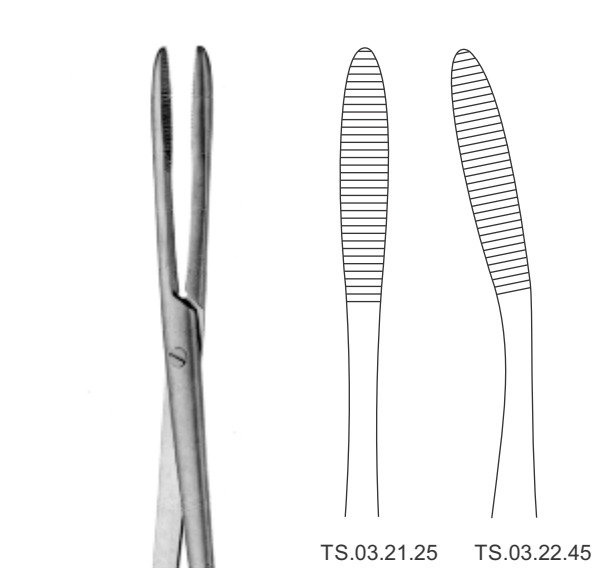

CHERON  
TS.03.23.75  
26 cm / 10 1/4"

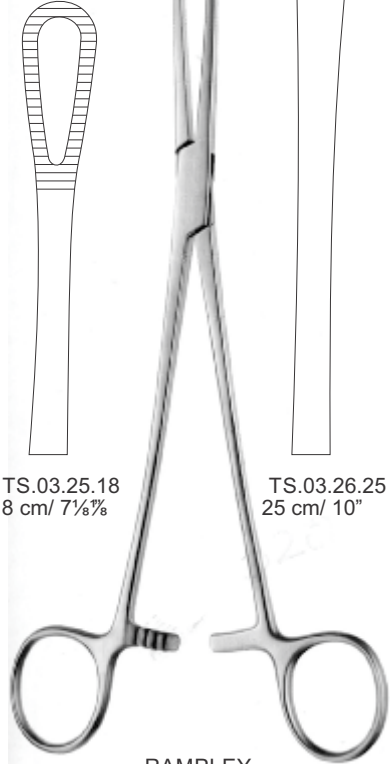
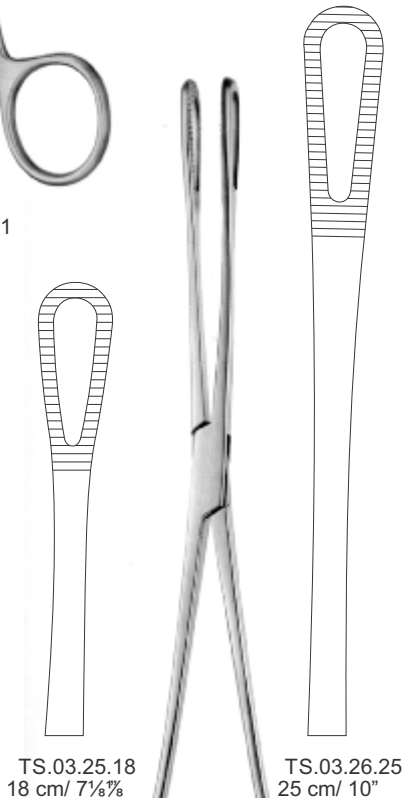

# Sponge Forceps

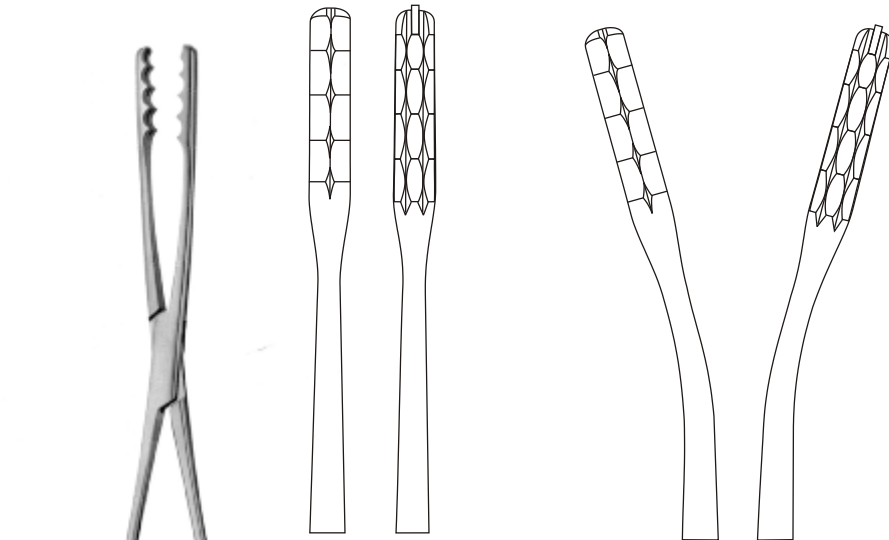

TS.03.27.18	18 cm/ 7"	TS.03.28.18
TS.03.27.20	20 cm/ 8"	TS.03.28.20
TS.03.27.22	22 cm/ 8¾"	TS.03.28.22
TS.03.27.26	26 cm/ 10¼"	TS.03.28.26



ULRICH

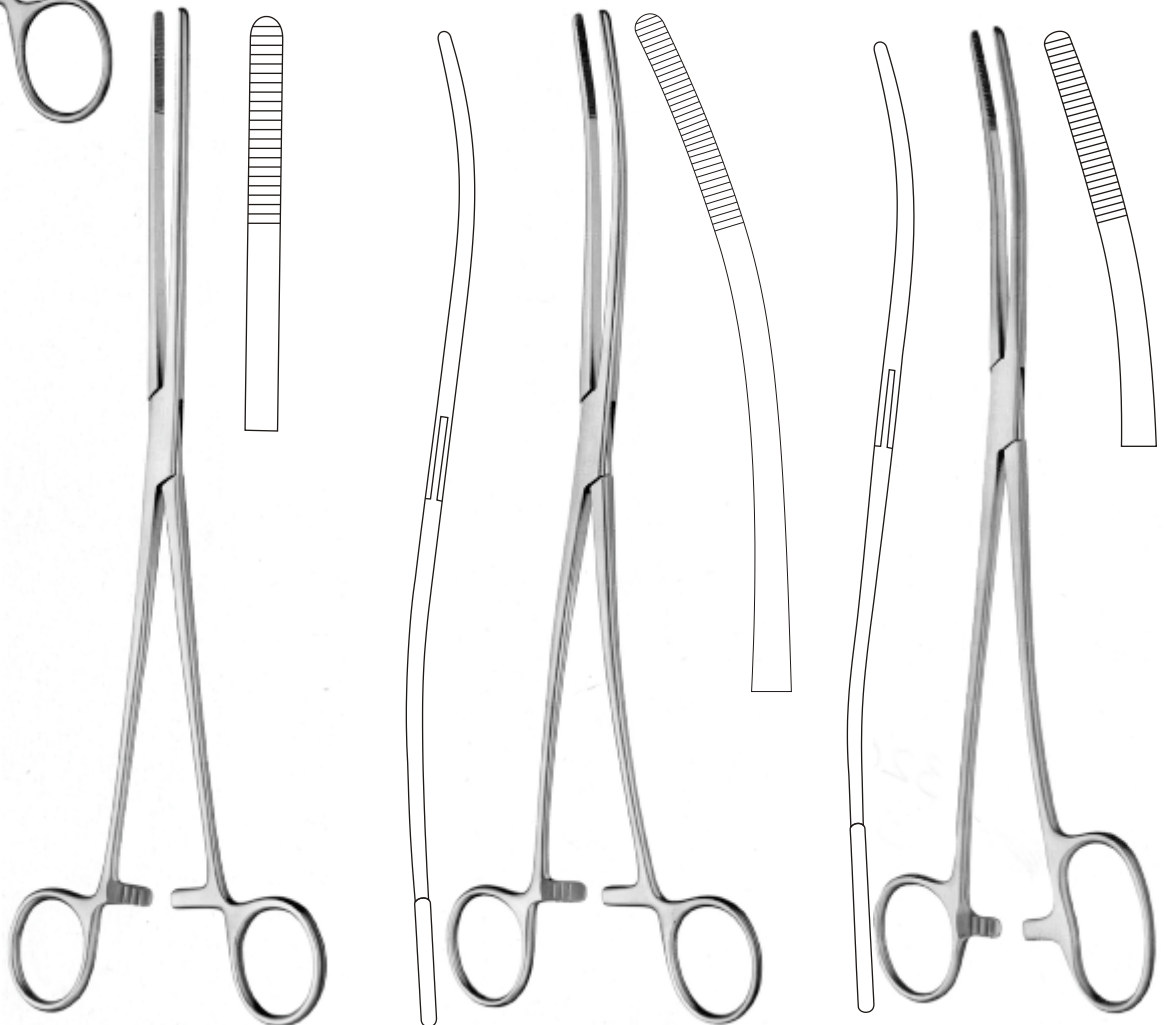

BOZEMANN  
TS.03.33.26  
27 cm/ 10¾"

BOZEMANN  
TS.03.34.26  
27 cm/ 10¾"

BOZEMANN DOUGLAS  
TS.03.35.26  
26 cm/ 10¼"

# Sponge Forceps

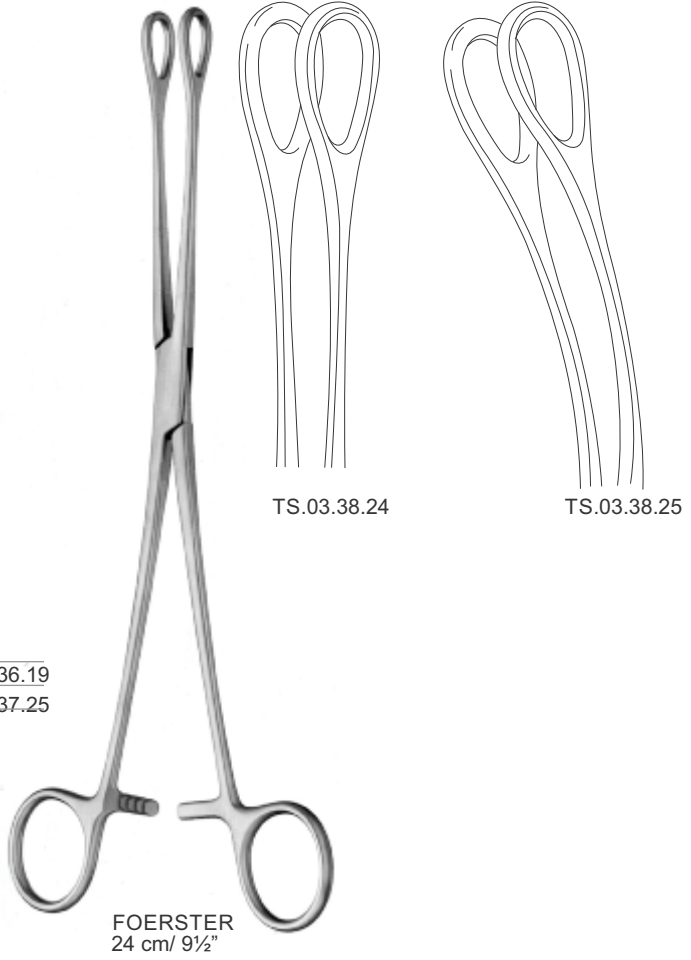
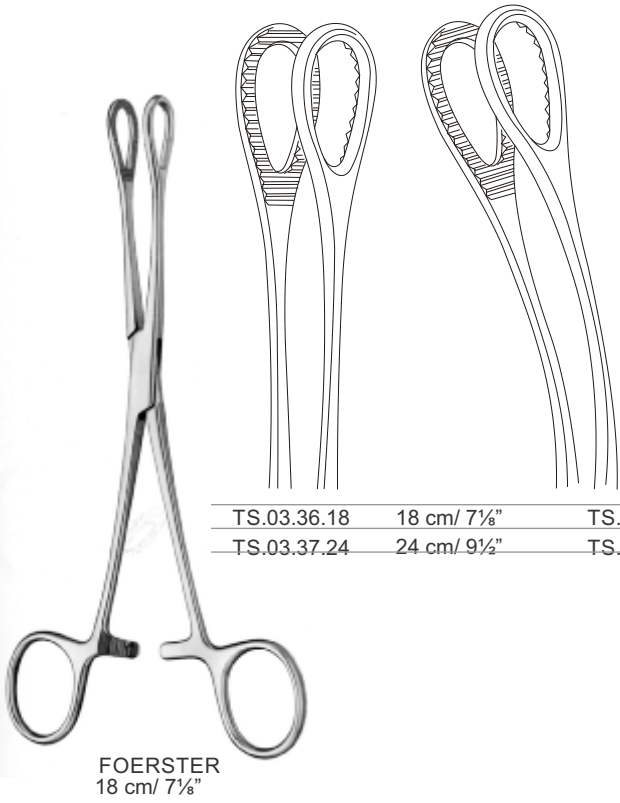

# Sponge Forceps



BERGMANN-FOERSTER  
TS.03.39.24  
24 cm/ 9½"



TS.03.40.24



FLETCHER (JAVERTS)  
TS.03.41.24  
24 cm/ 9½"

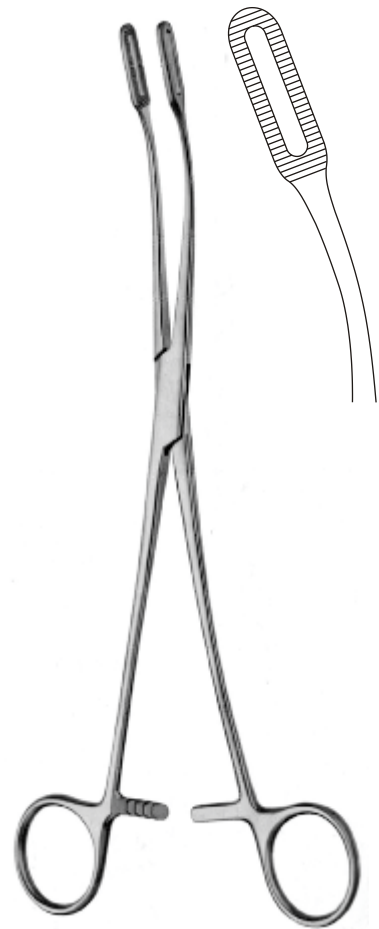

FLETCHER (JAVERTS)  
TS.03.42.24  
24 cm/ 9½"

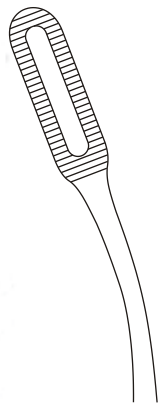

# Hemostatic Forceps



Hemostatic Forceps

# Hemostatic Forceps

## Bulldog Clamps



TS.03.01.35  
3.5 cm/ 1½"



TS.03.02.35  
3.5 cm/ 1½"



TS.03.01.38  
3.8 cm/ 1½"



TS.03.02.38  
3.8 cm/ 1½"



TS.03.01.50  
5 cm/ 2"



TS.03.02.50  
5 cm/ 2"



TS.03.03.55  
5.5 cm/ 2¼"



TS.03.04.55  
5.5 cm/ 2¼"



TS.03.04.08  
4.5 cm/ 1¾"



TS.03.04.12  
5 cm/ 2"



TS.03.04.16  
5.5 cm/ 2½"



DIEFFENBACH



DIETRICH



TS.03.04.28  
4.5 cm/ 1¾"

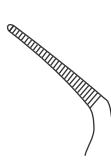

TS.03.04.32  
5 cm/ 2"

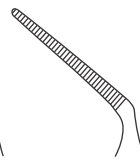

TS.03.04.36  
5.5 cm/ 2½"



DIETRICH



DIETRICH

1/1

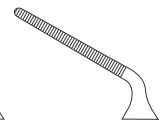
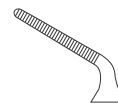

	TS.03.05.08	TS.03.05.10	TS.03.05.12	TS.03.05.18	TS.03.05.20	TS.03.05.22
Length	50 mm	50 mm	60 mm	50 mm	50 mm	60 mm
Jaws	8 mm	12 mm	20 mm	8 mm	12 mm	20 mm
Weight	3 gm	3 gm	3 gm	3 gm	3 gm	3 gm



# Hemostatic Forceps



**JOHNS-HOPKINS**  
TS.03.05.93  
24.5 cm / 9¾"

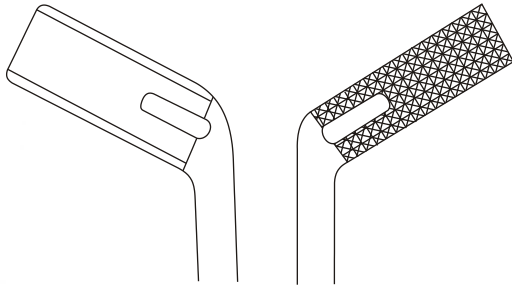

Applying forceps for Johns-Hopkins and Debaquey Bulldog clamps

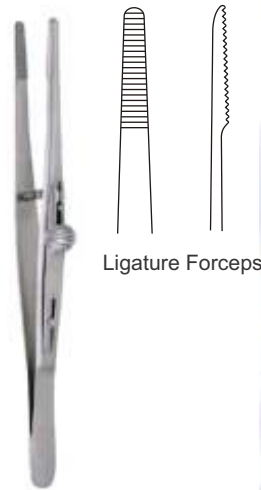

**FRICKE**  
TS.03.05.94  
13 cm / 5½"

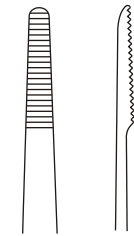

Ligature Forceps



**OVERHOLT-MIXTER**  
TS.03.07.80  
21 cm / 8¼"

## Bulldog Clamps



JOHNS-HOPKINS

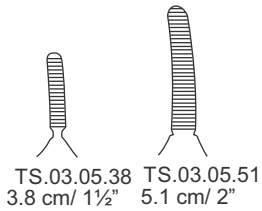

TS.03.05.38 3.8 cm / 1½"    TS.03.05.51 5.1 cm / 2"



JOHNS-HOPKINS

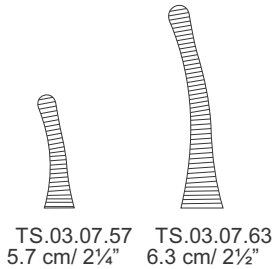

TS.03.07.57 5.7 cm / 2¼"    TS.03.07.63 6.3 cm / 2½"



JOHNS-HOPKINS

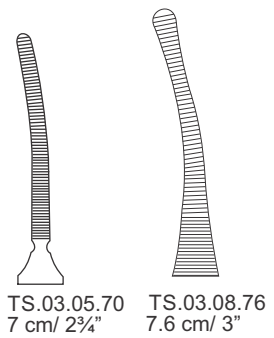

TS.03.05.70 7 cm / 2¾"    TS.03.08.76 7.6 cm / 3"

# Hemostatic Forceps



JOHNS-HOPKINS  
 TS.03.08.89  
 8.9 cm / 3½"



GREGORY "AT"

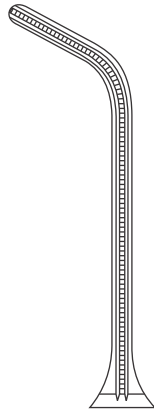

TS.03.09.91  
 11 cm / 4¼"

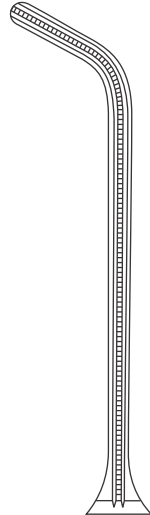

TS.03.09.92  
 12 cm / 4¾"



DEBAKEY "AT"  
 TS.03.09.95  
 6 cm / 2 3/5"



GREGORY "AT"  
 11 cm / 4¼"



TS.03.09.93 TS.03.09.94

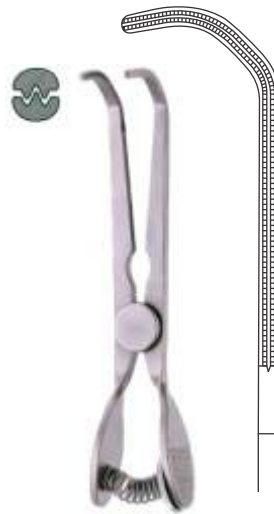

DEBAKEY "AT"  
 TS.03.09.96  
 11.5 cm / 4½"



DEBAKEY "AT"  
 TS.03.09.97  
 8 cm / 3"

# Hemostatic Forceps



Vasectomy  
TS.03.10.51  
12.5 cm/ 5"  
Pointed

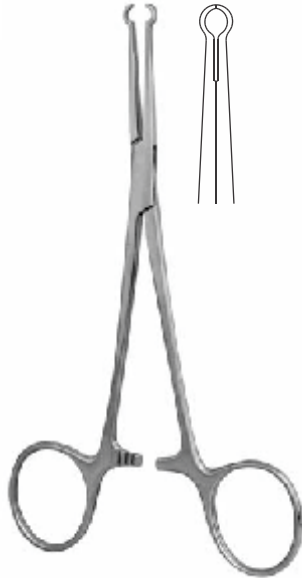

Vasectomy  
TS.03.10.52  
14 cm/ 5½"  
Ring Tip



HALSTED MOSQUITO

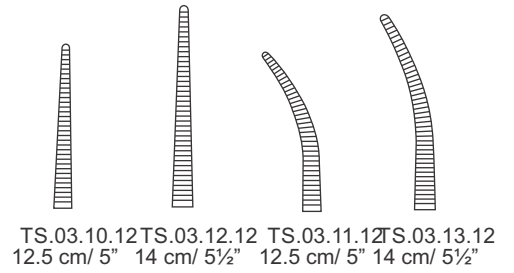

TS.03.10.12 12.5 cm/ 5"  
TS.03.12.12 14 cm/ 5½"  
TS.03.11.12 12.5 cm/ 5"  
TS.03.13.12 14 cm/ 5½"

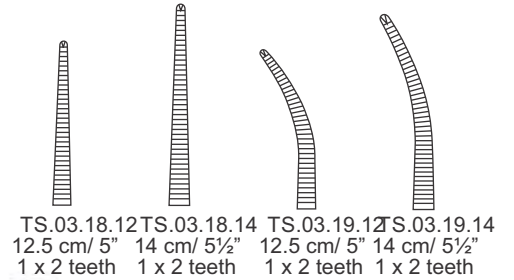

TS.03.18.12 12.5 cm/ 5"  
TS.03.18.14 14 cm/ 5½"  
TS.03.19.12 12.5 cm/ 5"  
TS.03.19.14 14 cm/ 5½"  
1 x 2 teeth 1 x 2 teeth 1 x 2 teeth 1 x 2 teeth

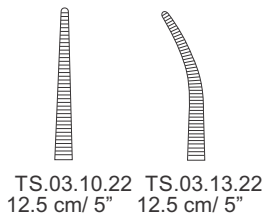

TS.03.10.22 12.5 cm/ 5"  
TS.03.13.22 12.5 cm/ 5"

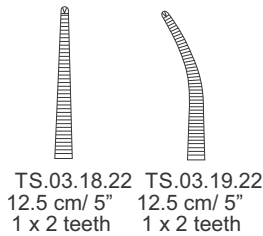

TS.03.18.22 12.5 cm/ 5"  
TS.03.19.22 12.5 cm/ 5"  
1 x 2 teeth 1 x 2 teeth



MICRO HALSTED MOSQUITO



10 cm/ 4"

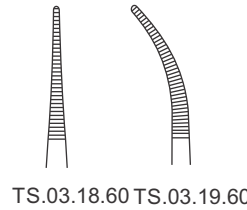

TS.03.18.60 TS.03.19.60



MOSQUITO "AT"  
12.5 cm/ 5"

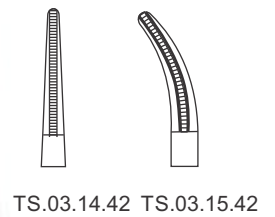

TS.03.14.42 TS.03.15.42

# Hemostatic Forceps



PACKER (SKILLMAN)  
12.5 cm / 5"



TS.03.14.82



TS.03.15.82



MICRO JACOBSON  
12.5 cm / 5"



TS.03.18.42



TS.03.19.42



MICRO JACOBSON  
(KOSHIMA)  
12.5 cm / 5"



TS.03.18.52



TS.03.19.52



12.5 cm / 5"

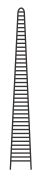

TS.03.18.62



TS.03.19.62



CHAPUT  
TS.03.20.13  
13 cm / 5 1/8"

1/1



TUFFIER  
TS.03.20.14  
13 cm / 5 1/8"



# Hemostatic Forceps



CHAPUT  
TS.03.20.23  
14 cm/ 5½"



TERRIER  
TS.03.21.13  
13 cm/ 5⅛"



TUFFIER  
TS.03.22.13  
13 cm/ 5⅛"

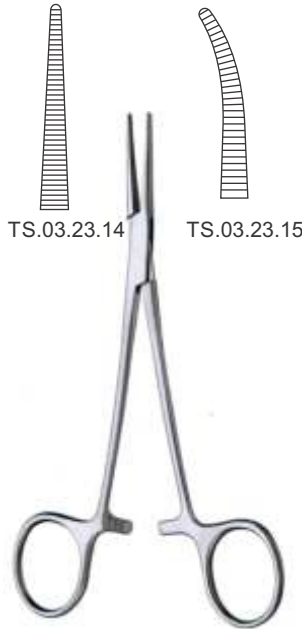

CRILE BABY  
14 cm/ 5½"



DANDY BABY  
TS.03.25.83  
13 cm/ 5⅛"



DANDY  
14 cm/ 5½"

1 x 2 teeth

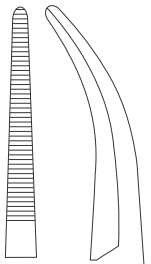

TS.03.25.84

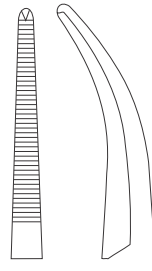

TS.03.25.94



RAIMONDI  
TS.03.25.97  
12.5 cm/ 5"

# Hemostatic Forceps



HOEN  
TS.03.25.98  
12.5 cm / 5"



CARREL (REYNOLDS)  
11 cm / 4 1/4"

TS.03.26.11

TS.03.27.11



HARTMANN  
(BABY-MOSQUITO)  
10 cm / 4"

TS.03.28.09

TS.03.29.09



PROVIDENCE HOSPITAL  
14 cm / 5 1/2"

TS.03.30.14

TS.03.31.14



PROVIDENCE HOSPITAL  
14 cm / 5 1/2"

TS.03.32.14

TS.03.33.14



LERICHE  
15 cm / 6"

TS.03.34.15

TS.03.35.15

# Hemostatic Forceps

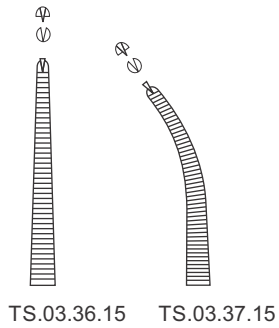

LERICHE  
15 cm / 6"

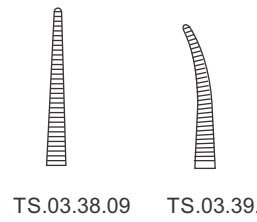

MICRO HARTMANN  
10 cm / 4"

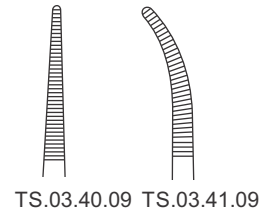
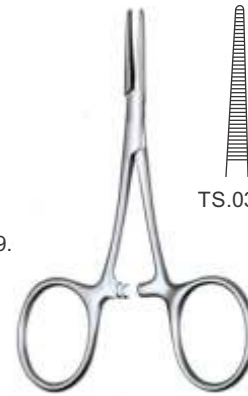

HARTMANN  
(BABY-MOSQUITO)  
10 cm / 4"

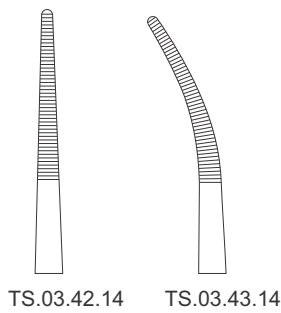

KELLY  
14 cm / 5½"

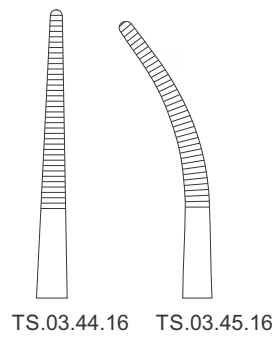

RANKIN KELLY  
16 cm / 6¼"

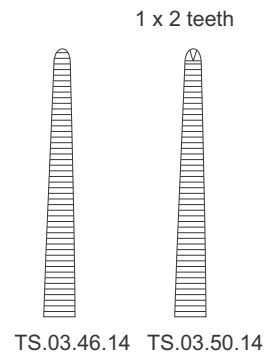

CRILE  
14 cm / 5½"

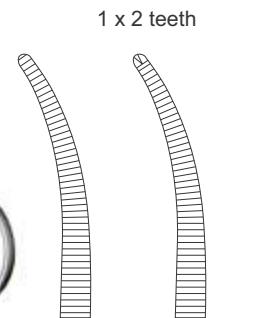

TS.03.47.14 TS.03.51.14

# Hemostatic Forceps

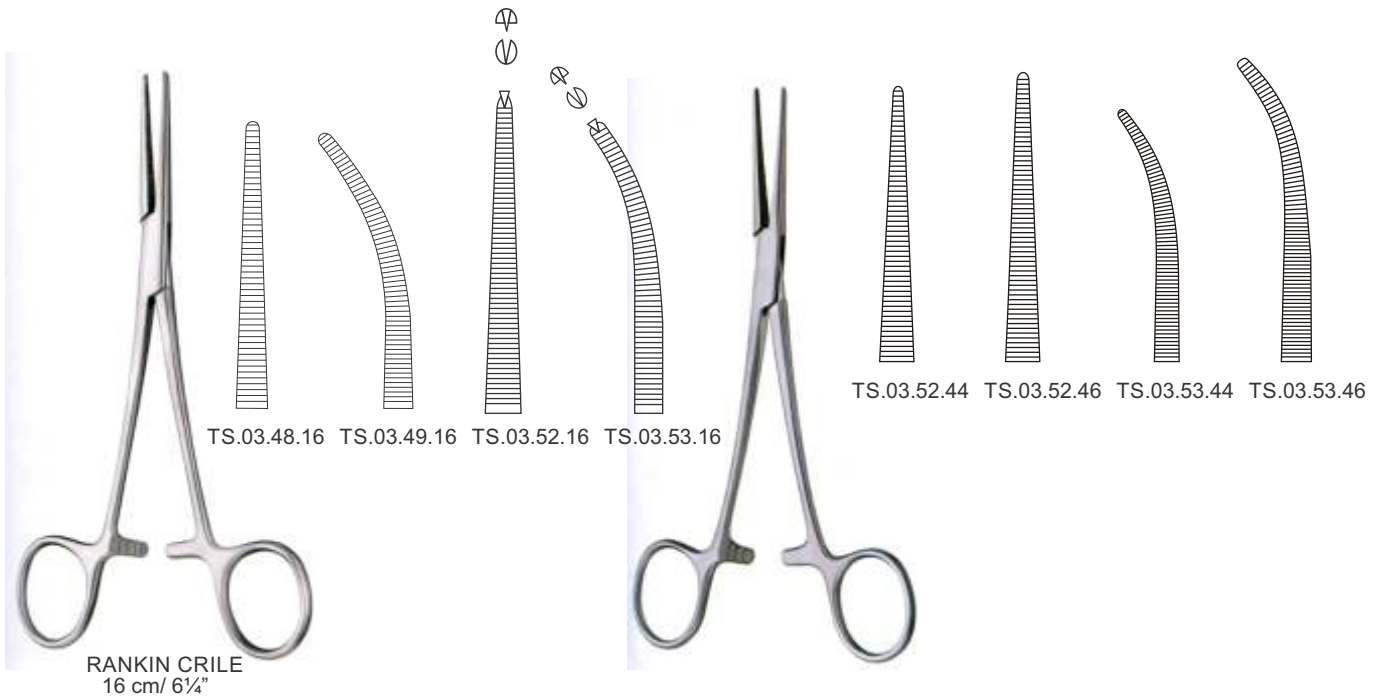



# Hemostatic Forceps



TS.03.56.1616 cm / 6¼"	TS.03.60.16
TS.03.56.1818 cm / 7⅛"	TS.03.60.18
TS.03.56.2020 cm / 8"	TS.03.60.20
TS.03.56.2222 cm / 8¾"	TS.03.60.22
TS.03.56.2424 cm / 9½"	TS.03.60.24
TS.03.56.2626 cm / 10¼"	TS.03.60.26

ROCHESTER PEAN

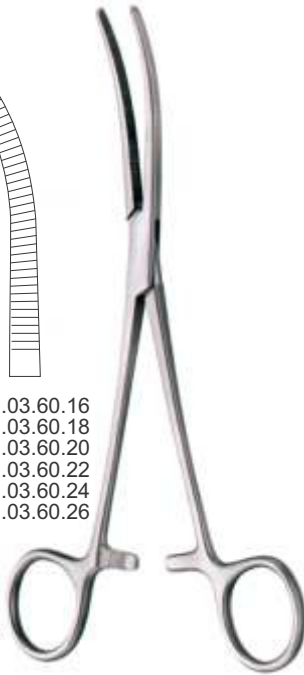

ROCHESTER PEAN



TS.03.57.14 14 cm / 5½"	TS.03.57.16 16 cm / 6¼"
----------------------------	----------------------------

PEAN



DEBAKEY PEAN "AT"

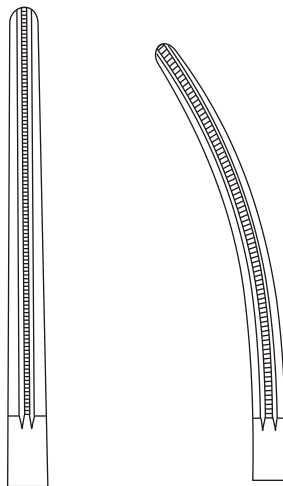

TS.03.59.50 20 cm / 8"	TS.03.60.50
TS.03.59.5626.5 cm / 10½"	TS.03.60.56
TS.03.59.5828 cm / 11"	TS.03.60.58



PEAN DIXON  
16 cm / 6¼"

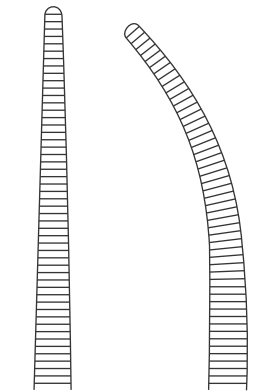

TS.03.58.16	TS.03.58.17
-------------	-------------

# Hemostatic Forceps

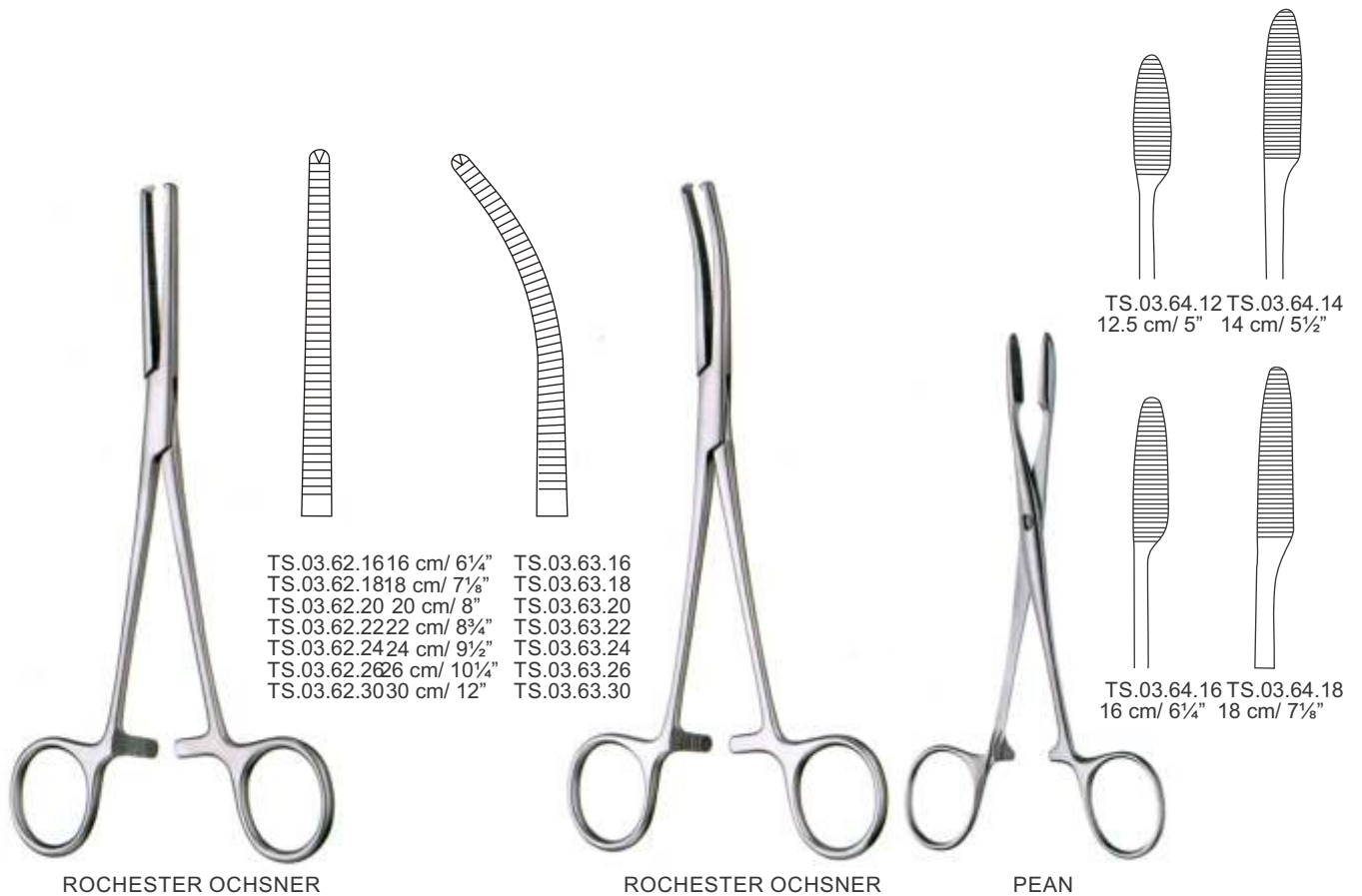
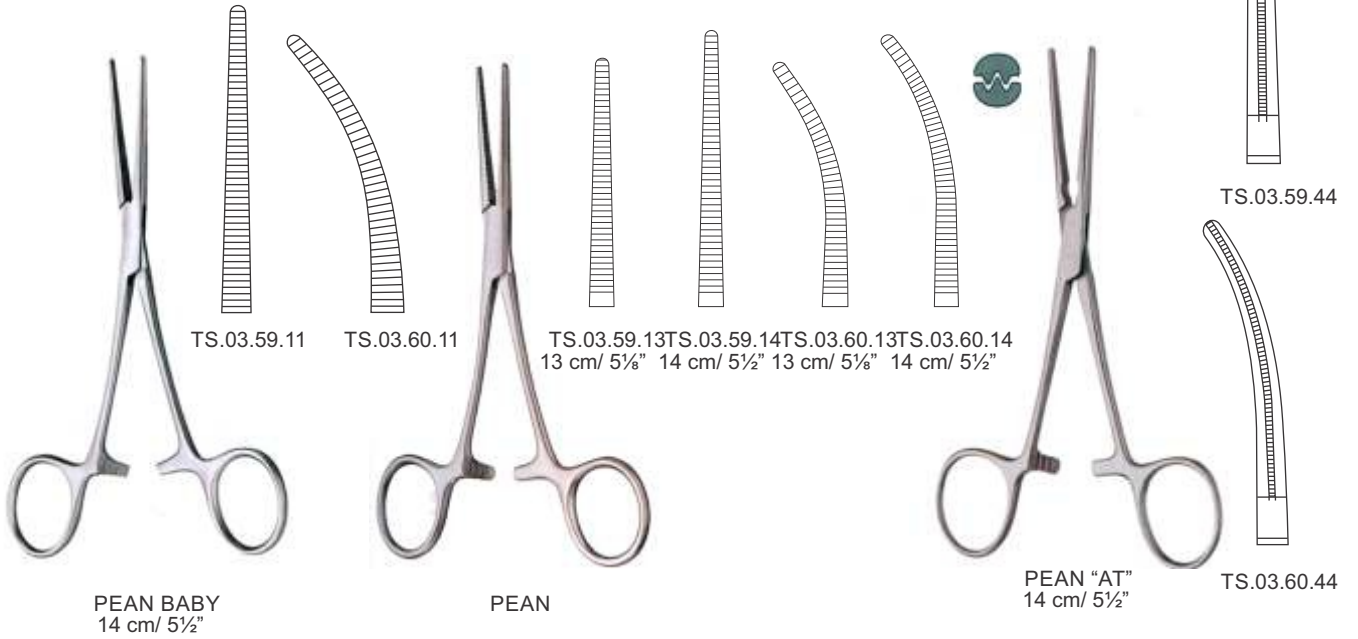

# Hemostatic Forceps



BENGOLEA

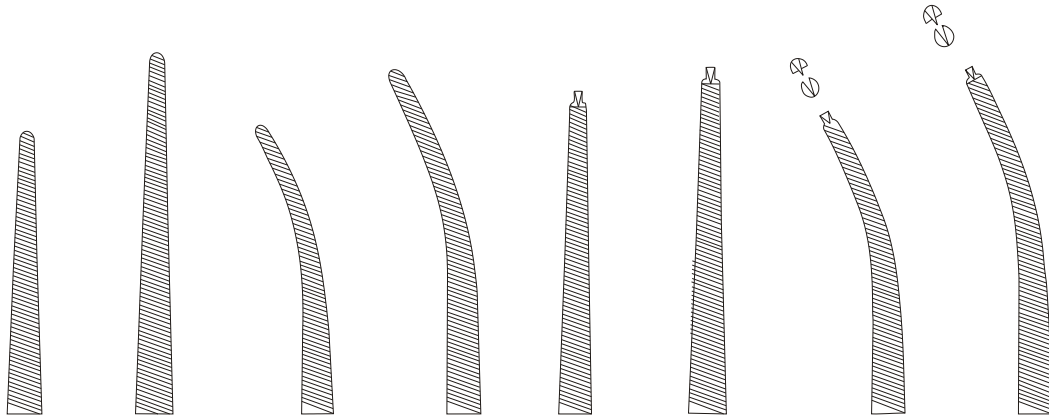

TS.03.64.20 20 cm/ 8"	TS.03.64.21 20 cm/ 8"	TS.03.64.26 26 cm/ 10¼"	TS.03.64.23 23 cm/ 9"	TS.03.65.20 20 cm/ 8"	TS.03.65.21 20 cm/ 8"	TS.03.65.26 26 cm/ 10¼"	TS.03.65.23 23 cm/ 9"
	TS.03.64.22 23 cm/ 9"		TS.03.64.27 26 cm/ 10¼"		TS.03.65.23 23 cm/ 9"		TS.03.65.27 26 cm/ 10¼"
	TS.03.64.24 24.5 cm/ 9½"		TS.03.64.25 24.5 cm/ 9½"		TS.03.65.24 24.5 cm/ 9½"		TS.03.65.25 24.5 cm/ 9½"



BENGOLEA

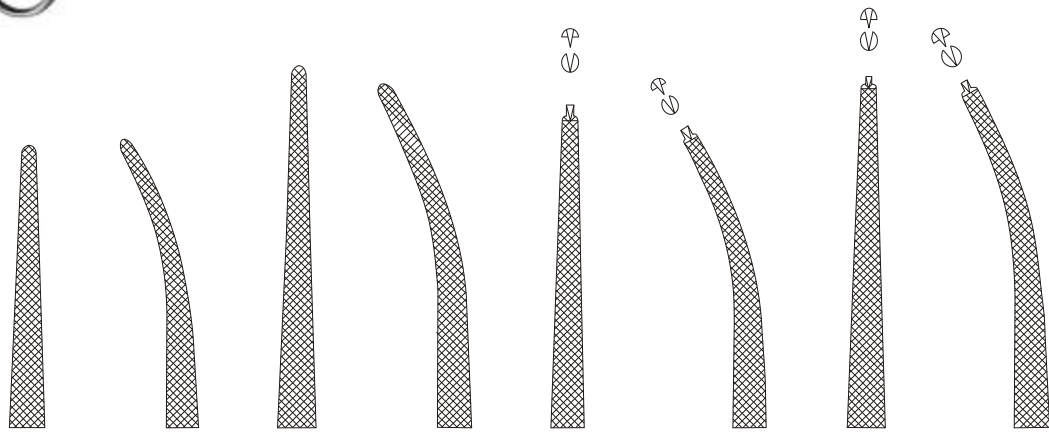

TS.03.64.40 20 cm/ 8"	TS.03.64.41 20 cm/ 8"	TS.03.64.43 23 cm/ 9"	TS.03.64.44 23 cm/ 9"	TS.03.65.40 20 cm/ 8"	TS.03.65.41 20 cm/ 8"	TS.03.65.43 23 cm/ 9"	TS.03.65.44 23 cm/ 9"
			TS.03.64.47 26 cm/ 10¼"				TS.03.65.47 26 cm/ 10¼"

# Hemostatic Forceps

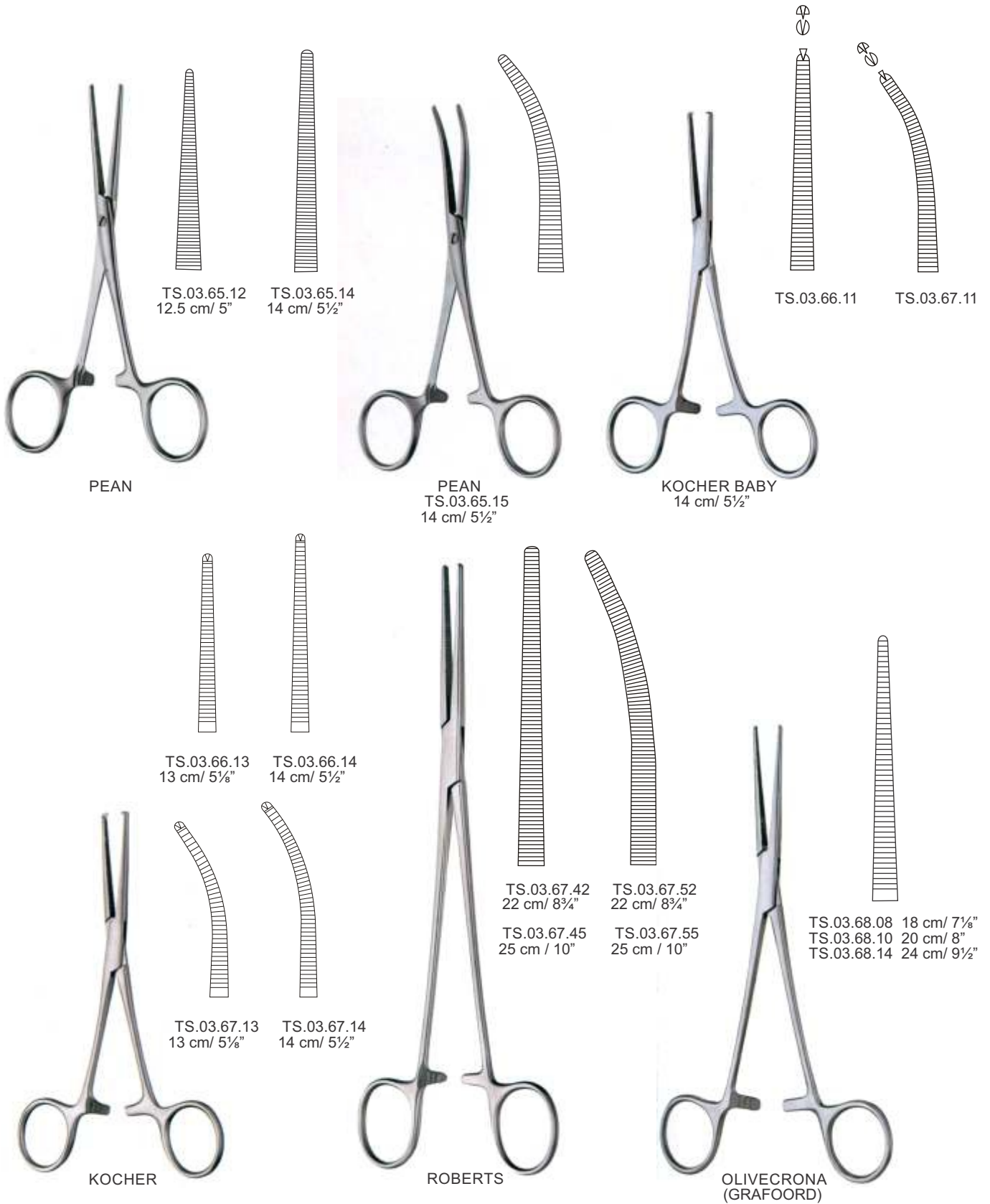

# Hemostatic Forceps



ZENKER  
29.5 cm / 11½"

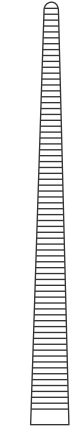

TS.03.68.28

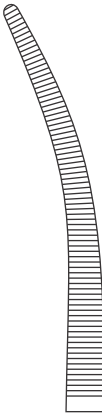

TS.03.68.29

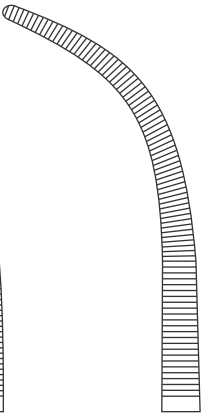

TS.03.68.30



SAROT  
24 cm / 9½"



TS.03.68.74

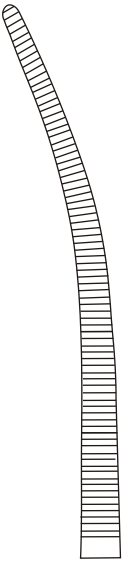

TS.03.68.75



CRAFOORD SELLORS  
24 cm / 9½"



TS.03.68.82

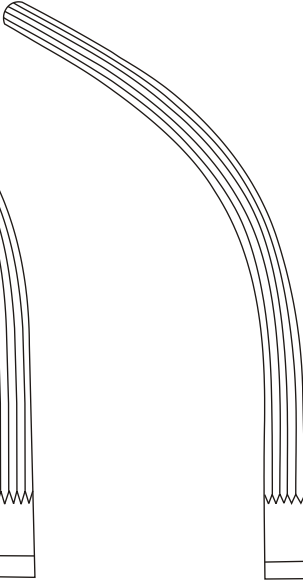

TS.03.68.83

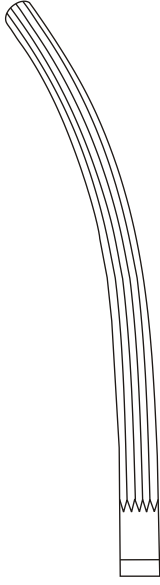

TS.03.68.84

# Hemostatic Forceps



RUMEL  
23 cm/ 9"

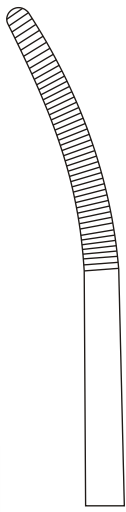

TS.03.69.01

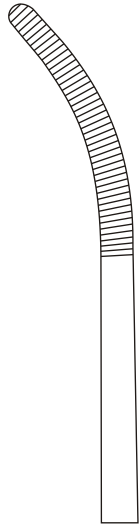

TS.03.69.02

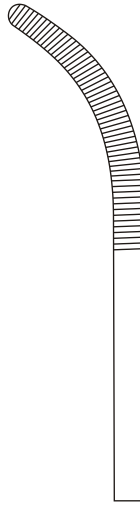

TS.03.69.03



TS.03.69.04

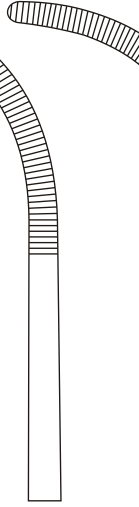

TS.03.69.05

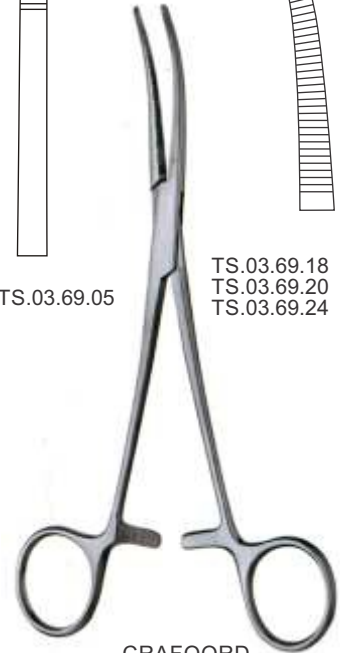

CRAFOORD  
(COLLER)

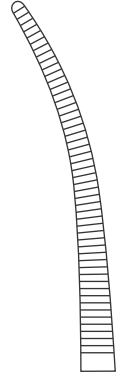

TS.03.69.18 18 cm/ 7 1/8"  
TS.03.69.20 20 cm/ 8"  
TS.03.69.24 24 cm/ 9 1/2"



DIXON LOVELACE  
16 cm/ 6 1/4"



TS.03.69.56

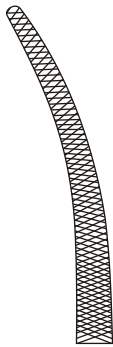

TS.03.69.57



LOVELACE  
TS.03.69.85  
15 cm/ 6"



DIXON LOVELACE  
TS.03.69.86  
16 cm/ 6 1/4"

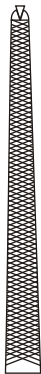

# Hemostatic Forceps

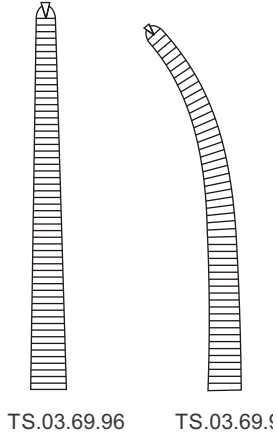

OCHSNER DIXON  
16 cm / 6 1/4"



KOCHER  
TS.03.70.14  
14 cm / 5 1/2"



KOCHER  
TS.03.74.14  
14 cm / 5 1/2"

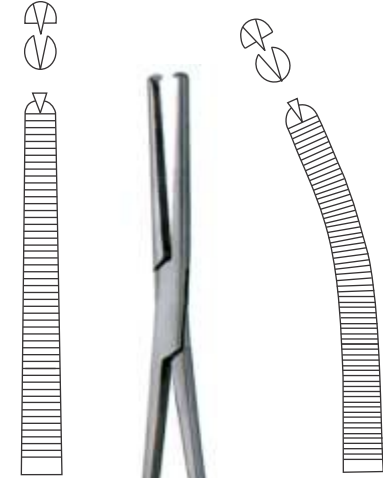

TS.03.72.33

TS.03.72.34



HOLZBAGH  
23.5 cm / 9 1/4"

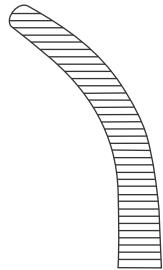

TS.03.73.23  
23 cm / 9"

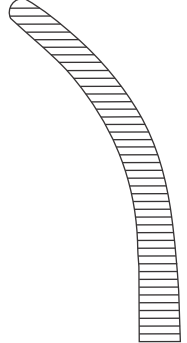

TS.03.73.24  
24 cm / 9 1/2"



MOYNIHAN

# Hemostatic Forceps

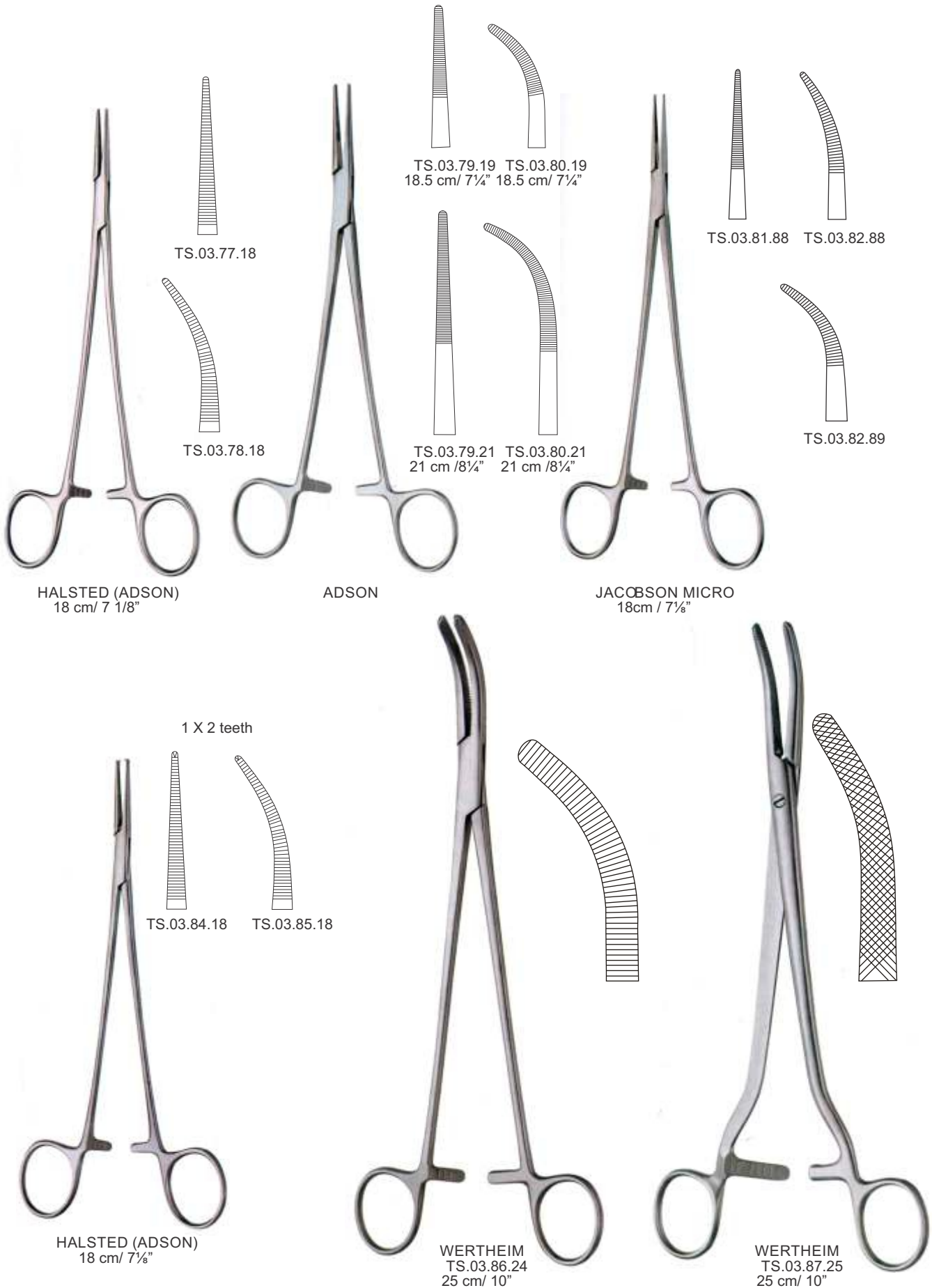



# Hemostatic Forceps



WERTHEIM  
TS.03.88.43  
23 cm/ 9"



TS.03.89.16 16 cm/ 6¼"  
TS.03.89.20 20 cm/ 8"  
TS.03.89.23 23 cm/ 9"

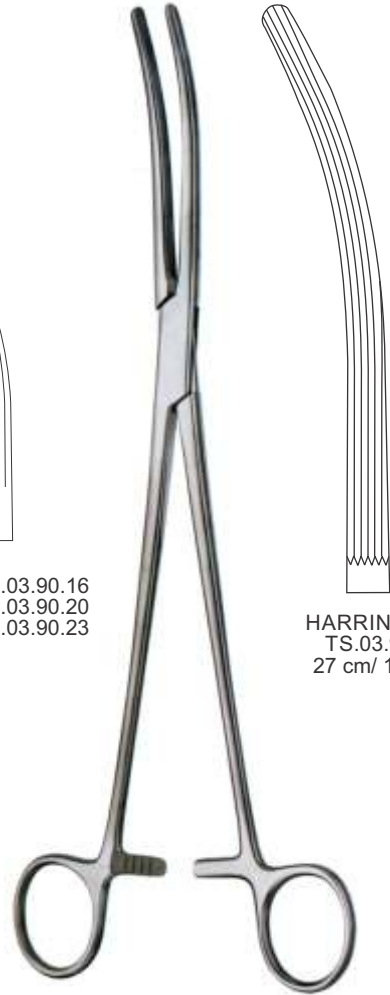

HARRINGTON  
TS.03.90.27  
27 cm/ 10¾"



FERGUSON  
16.5 cm/ 6½"

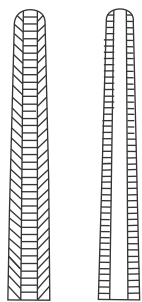

TS.03.91.16

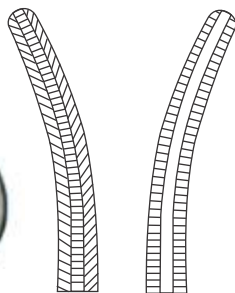

TS.03.91.19



PHANEUF  
21 cm/ 8¼"



TS.03.91.21

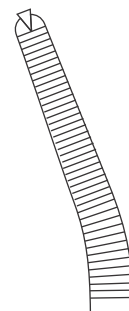

TS.03.92.21

# Hemostatic Forceps



FAURE  
 21 cm / 8 1/4"



TS.03.93.20

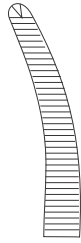

TS.03.93.21



FAURE  
 TS.03.93.75  
 25 cm / 10"

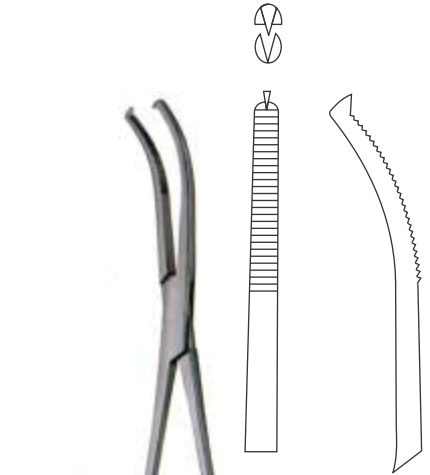
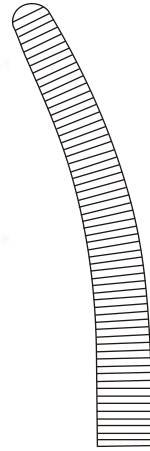

MILKULICZ  
 TS.03.94.48  
 18.5 cm / 7 1/4"

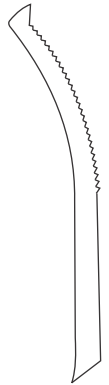

MILKULICZ  
 TS.03.94.14  
 14.5 cm / 5 3/4"



MILKULICZ



TS.03.94.38  
 18 cm / 7 1/8"

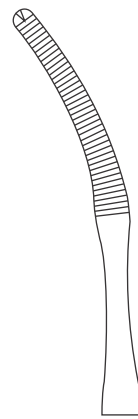

TS.03.94.40  
 20 cm / 8"



MILKULICZ  
 TS.03.94.58  
 18 cm / 7 1/8"

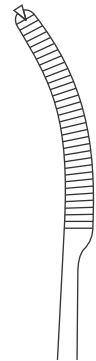

1 x 2 teeth

# Hemostatic Forceps



MIKULICZ  
20 cm / 8"

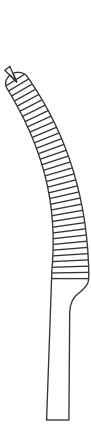

TS.03.94.60

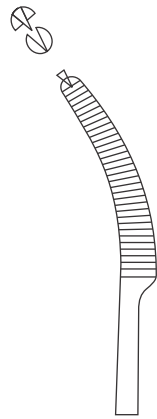

TS.03.94.61



MIKULICZ  
20 cm / 8"

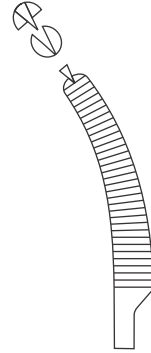

TS.03.94.70



WERTHEIM "AT"

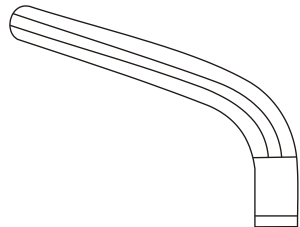

TS.03.94.35  
19.5 cm / 7 3/4"

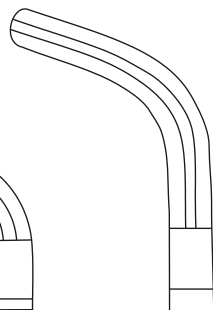

TS.03.94.34  
20.5 cm / 8"

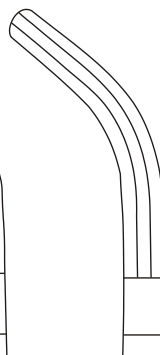

TS.03.94.33  
21.5 cm / 8 1/2"

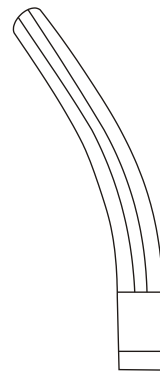

TS.03.94.31  
22 cm / 8 3/4"



TS.03.94.30  
22 cm / 8 3/4"

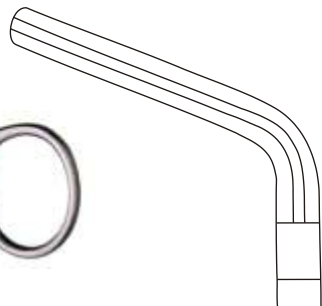

TS.03.94.55  
23 cm / 9"

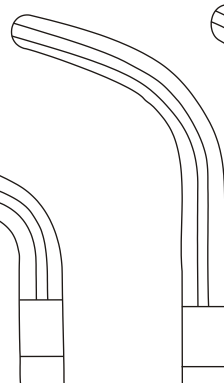

TS.03.94.54  
23.5 cm / 9 1/4"

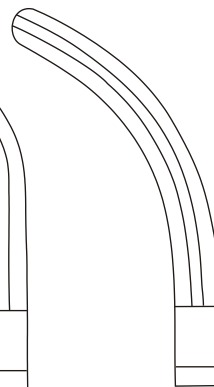

TS.03.9453  
24 cm / 9 1/2"

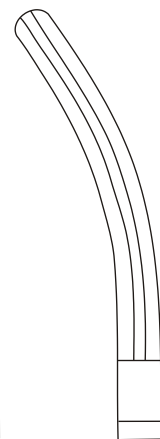

TS.03.94.51  
24.5 cm / 9 3/4"



TS.03.94.50  
25 cm / 10"

# Hemostatic Forceps



# Hemostatic Forceps



OVERHOLT BABY  
TS.03.99.13  
13.5 cm / 5¼"



FUCHSIG  
TS.03.99.19  
19 cm / 7½"



MEEKER  
TS.03.99.27  
27 cm / 10¾"



OVERHOLT SLIM

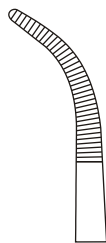

TS.03.99.28  
18.5 cm / 7¼"

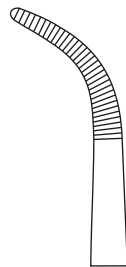

TS.03.99.30  
20.5 cm / 8"

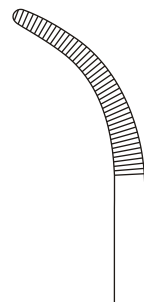

TS.03.99.31  
21 cm / 8¼"

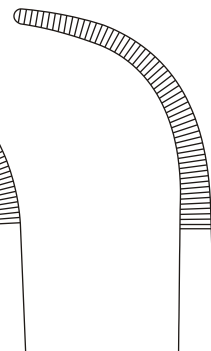

TS.03.99.32  
21.5 cm / 8½"

# Hemostatic Forceps



TS.03.99.49  
 19 cm / 7½"

OVERHOLT  
 GEISSENDOERFER

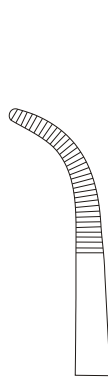

TS.03.99.49  
 19 cm / 7½"

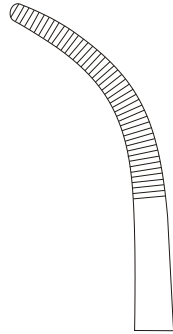

TS.03.99.51  
 21.5 cm / 8½"

TS.03.99.67  
 27 cm / 10¾"

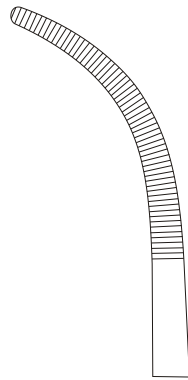

TS.03.99.52  
 22.5 cm / 9"

TS.03.99.68  
 28 cm / 11"

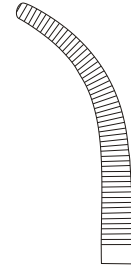

TS.03.99.60  
 20.5 cm / 8⅛"

TS.03.99.76  
 26 cm / 10¼"

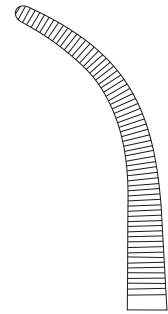

TS.03.99.61  
 21 cm / 8¼"

TS.03.99.77  
 27 cm / 10¾"

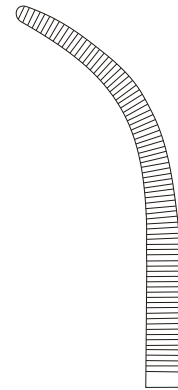

TS.03.99.62  
 22.5 cm / 9"

TS.03.99.78  
 27.5 cm / 10¾"

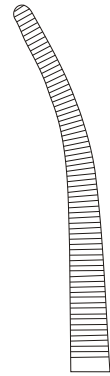

TS.03.99.63  
 23.5 cm / 9¼"

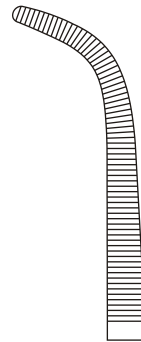

TS.03.99.64

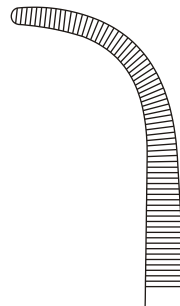

TS.03.99.65



OVERHOLT MIOTTI  
 24 cm / 9½"

# Hemostatic Forceps

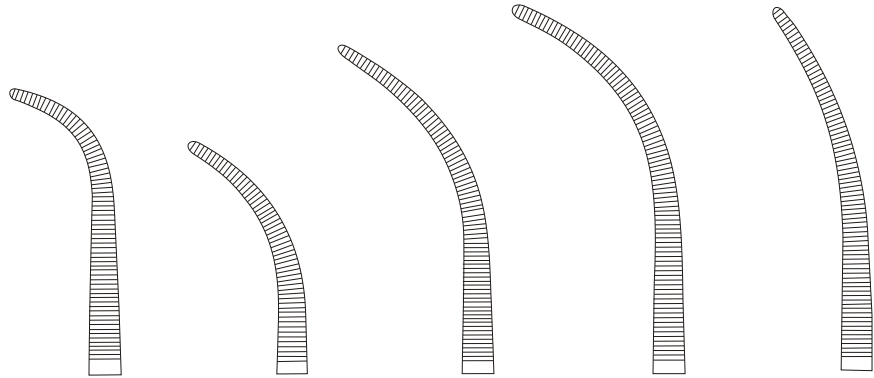

TS.03.99.82  
22 cm/ 8¾"

TS.03.99.83  
21.5 cm/ 8½"

TS.03.99.84  
22.5 cm/ 8¾"

TS.03.99.85  
23 cm/ 9"

TS.03.99.86  
23 cm/ 9"



OVERHOLT  
delicate pattern

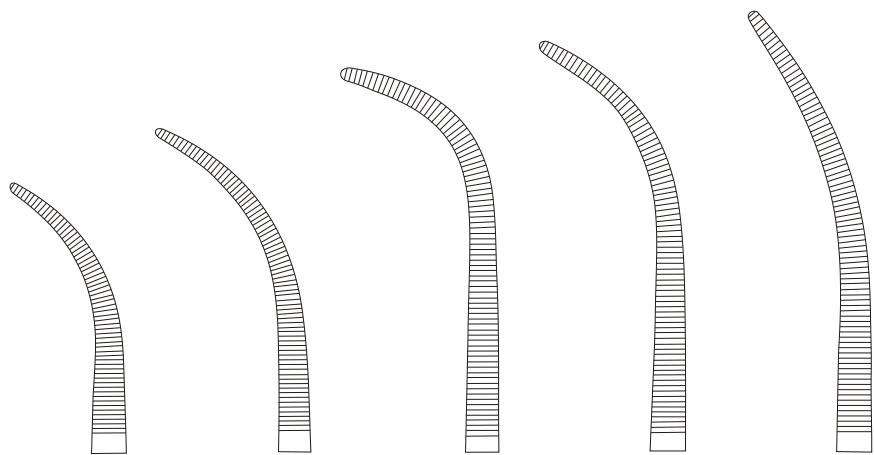

TS.03.99.87  
26.5 cm/ 10½"

TS.03.99.88  
27.5 cm/ 10¾"

TS.03.99.89  
30 cm/ 11¾"

TS.03.99.90  
30 cm/ 11¾"

TS.03.99.91  
30.5 cm/ 12"

# Dissecting Forceps

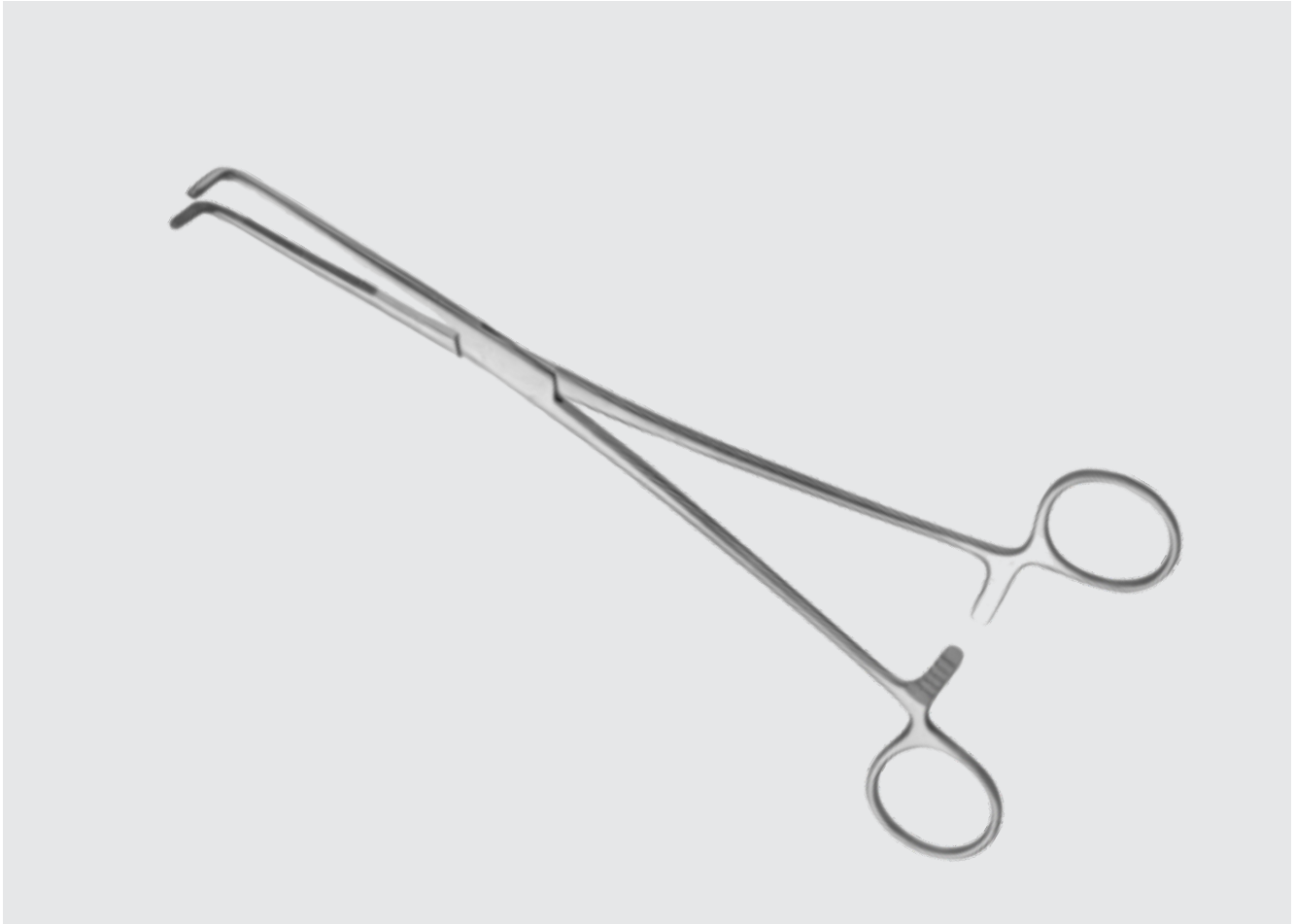



# Dissecting Forceps



ADSON BABY

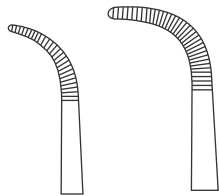

TS.03.01.14 14 cm / 5½"  
TS.03.02.19 19 cm / 7½"



MIXTER BABY

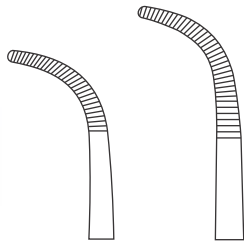

TS.03.03.14 14 cm / 5½"  
TS.03.04.19 19 cm / 7½"



TS.03.05.14  
14 cm / 5½"



TS.03.05.89  
19 cm / 7½"



MIXTER

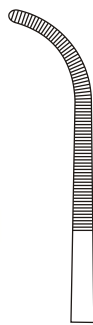

TS.03.06.18 18 cm / 7¼"  
TS.03.06.23 23 cm / 9"

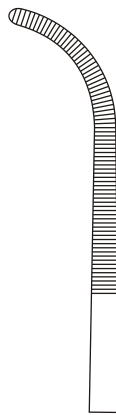

ROCHESTER MIXTER

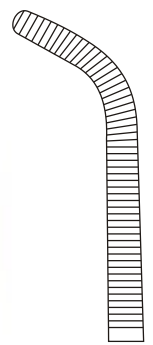

TS.03.06.36  
16 cm / 6¼"

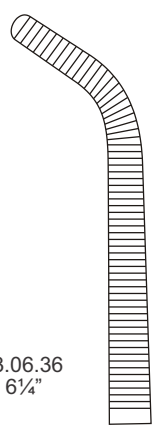

TS.03.06.40  
20 cm / 8"

# Dissecting Forceps



**JOHNS HOPKINS**  
TS.03.06.45  
20 cm / 8"



**MIXER CRAFOORD**  
TS.03.07.75 25 cm / 10"  
TS.03.07.76 15 cm / 6"  
TS.03.07.77 27 cm / 10¾"  
TS.03.07.78 18 cm / 7⅙"  
TS.03.07.80 20 cm / 8"



**WIKSTROEM**  
TS.03.07.81 21 cm / 8¼"  
TS.03.07.83 23 cm / 9"  
TS.03.07.84 24 cm / 9½"



**GEMINI**

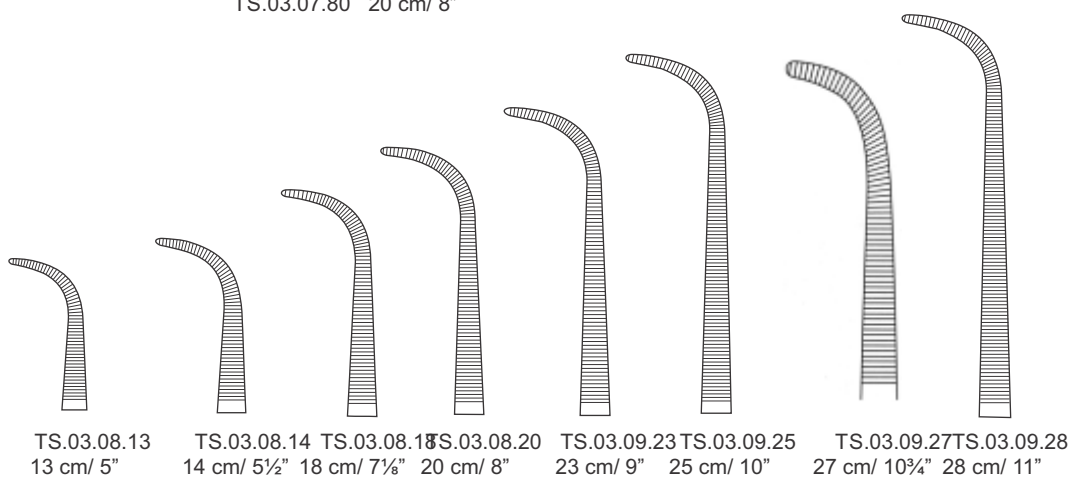

# Dissecting Forceps



TS.03.10.50  
SCHNIDT  
(BOETTCHER)

19 cm / 7½"

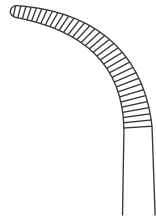

TS.03.10.55  
SCHNIDT  
(SAWTELL)



TS.03.11.51  
SCHNIDT  
(BOETTCHER)

19 cm / 7½"

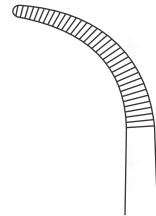

TS.03.11.56  
SCHNIDT  
(SAWTELL)



LAHEY (SWEET)  
TS.03.12.09  
19 cm / 7½"

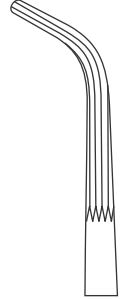

LAHEY

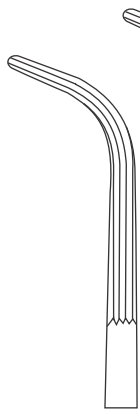

TS.03.12.19  
19 cm / 7½"

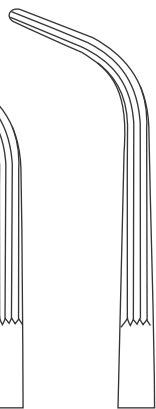

TS.03.12.23  
23 cm / 9"



HOHENFELLNER

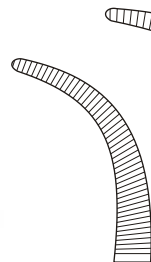

TS.03.12.78  
18 cm / 7 ⅛"

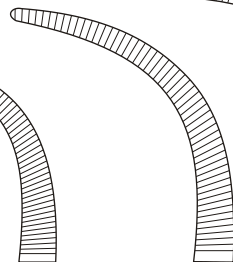

TS.03.12.81  
21 cm / 8¼"

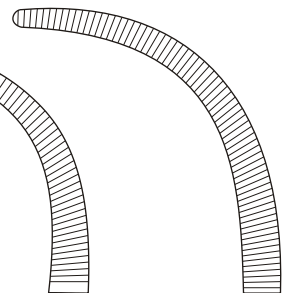

TS.03.12.84  
24 cm / 9½"

# Dissecting Forceps



O'SHAUGNESSY  
 TS.03.12.50  
 20 cm / 8"

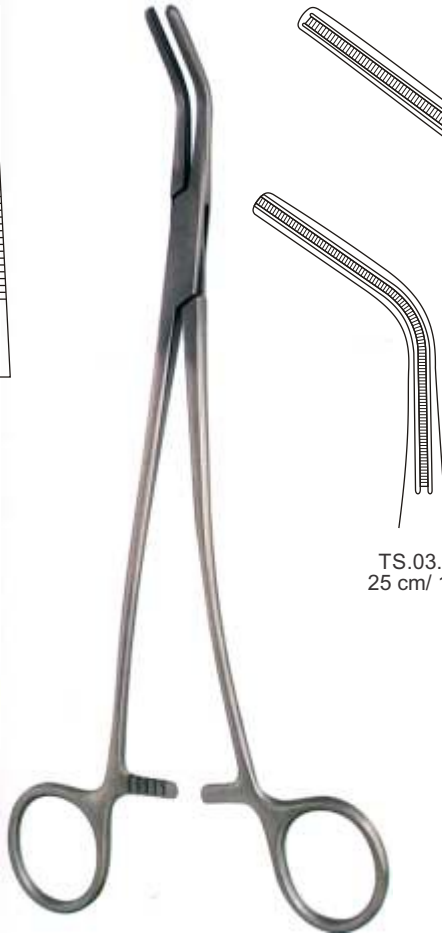

HOHENFELLNER "AT"

TS.03.12.85  
 25 cm / 10"

TS.03.12.86  
 26 cm / 10 1/4"



DEBAKEY MIXTER  
 TS.03.13.35  
 20 cm / 8"



MIXTER

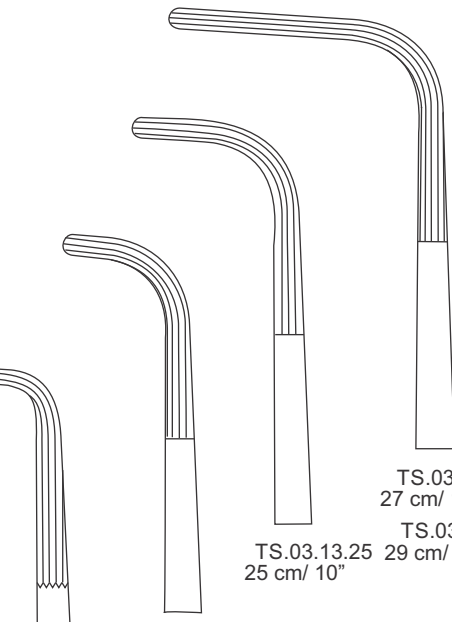

TS.03.13.19 19 cm / 7 1/2" TS.03.13.22 22 cm / 8 3/4"

TS.03.13.27  
 27 cm / 10 3/4"

TS.03.13.29 29 cm / 11 1/2"  
 TS.03.13.25 25 cm / 10"



BRUNSCHWIG  
 TS.03.13.52  
 22 cm / 8 3/4"

# Dissecting Forceps

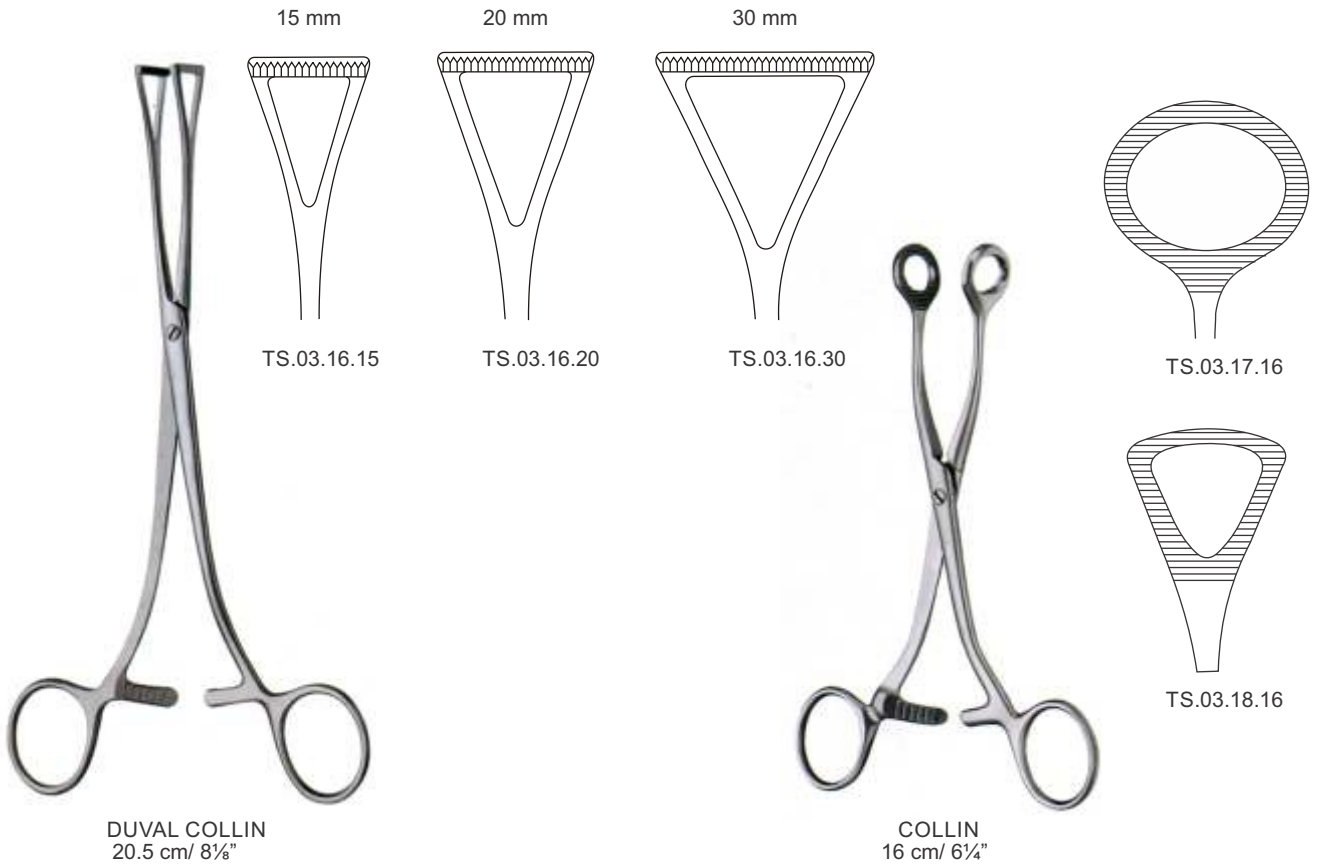
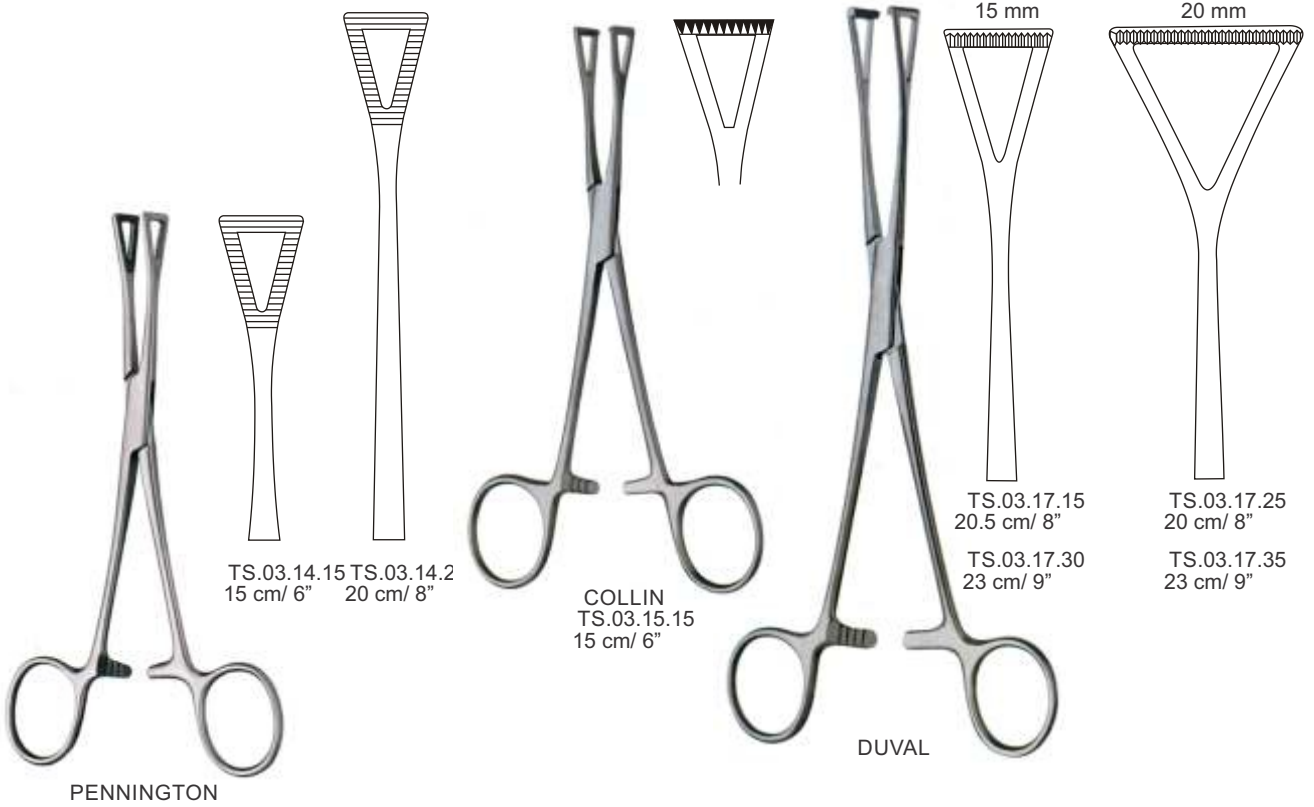

# Dissecting Forceps

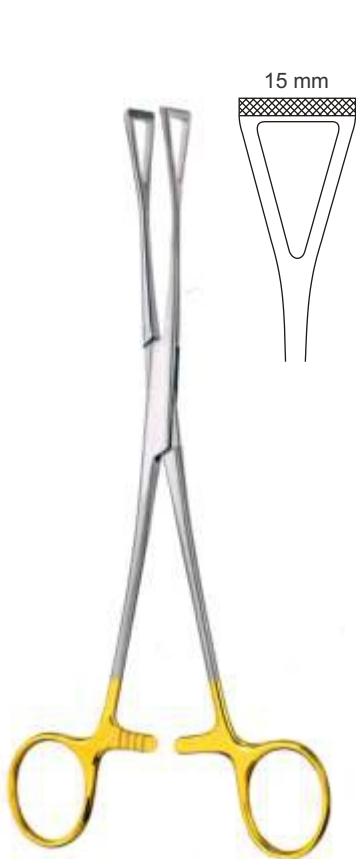

DUVAL "TC"  
TS.03.17.46  
20 cm / 8"



DUVAL "AT"  
TS.03.17.82  
23 cm / 9"

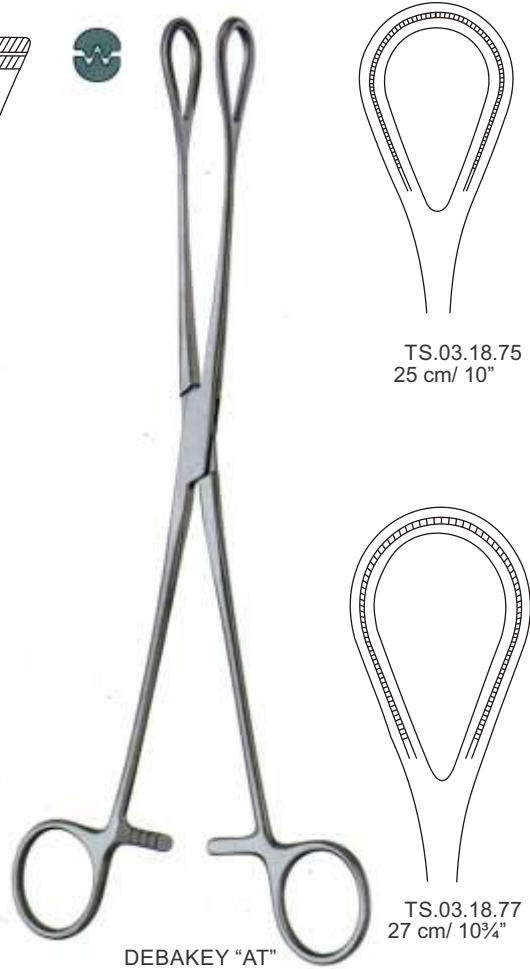

TS.03.18.75  
25 cm / 10"

TS.03.18.77  
27 cm / 10 3/4"

DEBAKEY "AT"

# Dissecting Forceps



TS.03.19.05  
5.5 cm/ 2 1/8"



JONES  
TS.03.20.08  
8 cm/ 3"



SCHAEFFEL  
TS.03.21.08  
8 cm/ 3"



TS.03.22.08  
8cm/ 3"



DOYEN  
TS.03.24.18  
18 cm/ 7 1/8"

TS.03.20.09  
9 cm/ 3 1/2"

TS.03.21.09  
9 cm/ 3 1/2"



BACKHAUS  
TS.03.25.08 8.5 cm/ 3 1/4"  
TS.03.25.10 10.5 cm/ 4 1/8"  
TS.03.26.13 13 cm/ 5 1/8"  
TS.03.26.15 15 cm/ 6"



TOHOKU  
TS.03.27.10 10 cm/ 4"  
TS.03.27.13 13 cm/ 5"



BERNHARD (STAUDE)  
TS.03.27.16  
16 cm/ 6 1/4"



BACKHAUS ROEDER  
TS.03.28.13 13 cm/ 5 1/8"  
TS.03.28.15 15 cm/ 6"

# Dissecting Forceps



OMBREDANNE (JACKSON)  
TS.03.29.13  
13.5 cm / 5¼"

PROFESSIONAL  
TS.03.29.14  
13 cm / 5½"

EDNA (LORNA)  
TS.03.30.10  
10 cm / 4"

EDNA (LORNA)  
TS.03.30.34  
14 cm / 5½"



BALL & SOCKET  
TS.03.30.11 11 cm / 4¼"  
TS.03.30.13 13 cm / 5½"  
TS.03.30.15 15 cm / 6"



LANE  
TS.03.33.15 15 cm / 6"  
TS.03.33.18 18 cm / 7½"  
TS.03.33.20 20 cm / 8"



TS.03.36.14  
14.5 cm / 5¾"



# Dissecting Forceps

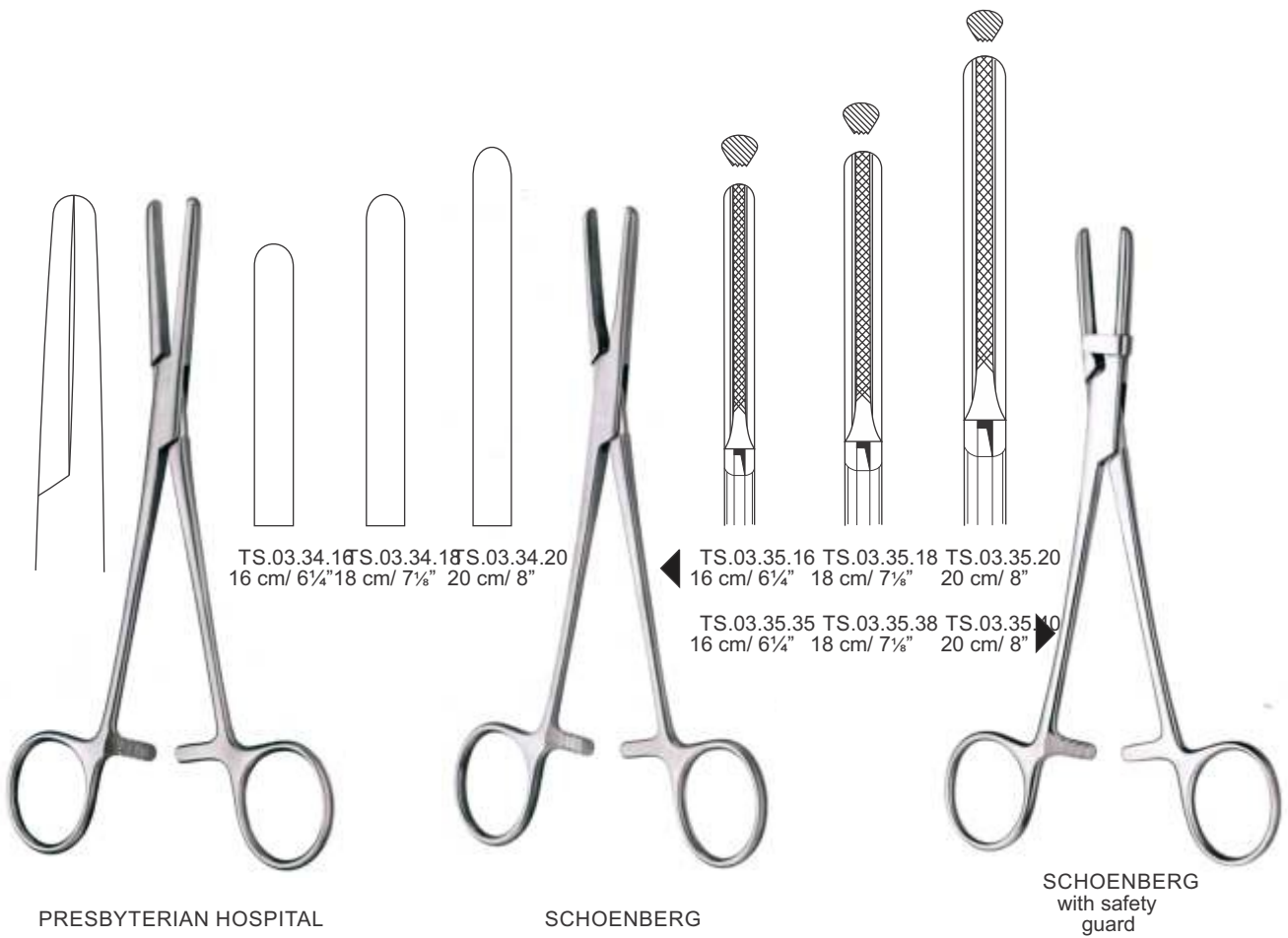



Needle Holders

# Needle Holders

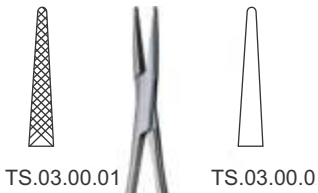

**HALSTED**  
11.5 cm/ 4½"

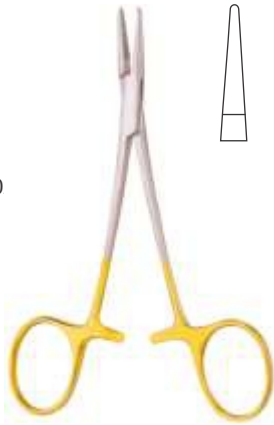

**HALSTED "TC"**  
TS.03.00.51  
11.5 cm/ 4½"



**DERF**  
12 cm/ 4¾"



**WEBSTER**  
TS.03.01.12  
12.5 cm/ 5"



**WEBSTER "TC"**  
TS.03.02.62  
12.5 cm/ 5"



**HALSEY**  
TS.03.03.13  
13.5 cm/ 5¼"



**HALSEY "TC"**

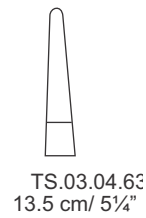
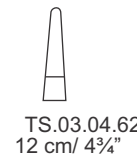

**COLLIER**  
TS.03.05.13  
13 cm/ 5⅝"

# Needle Holders



**BAUMGARTNER**  
 TS.03.05.14  
 14 cm / 5½"

**BAUMGARTNER "TC"**  
 TS.03.05.64  
 14 cm / 5½"

**BROWN**  
 TS.03.06.13 13 cm / 5¼"  
 TS.03.08.18 18 cm / 7¼"

**CONVERSE**  
 TS.03.06.15  
 15 cm / 6"



**CONVERSE "TC"**  
 TS.03.07.65  
 15 cm / 6"

**NAGATA**

TS.03.08.61 TS.03.08.63  
 11.5 cm / 4½" 13 cm / 5¼"

**NEIVERT**  
 TS.03.09.12  
 12.5 cm / 5"

# Needle Holders



# Needle Holders



NEW ORLEANS  
TS.04.18.18  
18 cm / 7½"



NEW ORLEANS "TC"  
TS.04.19.68  
18 cm / 7½"



CRILE WOOD

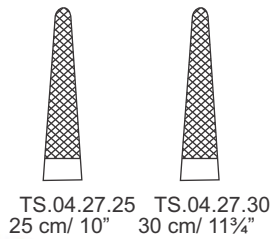
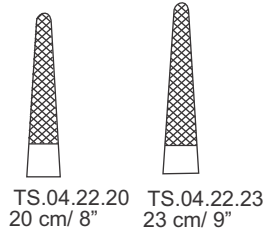
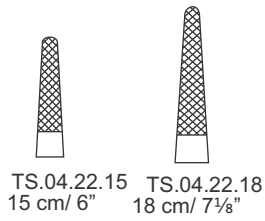
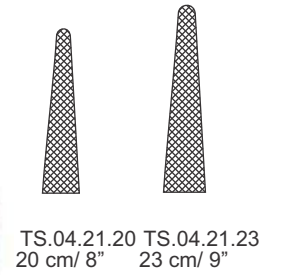
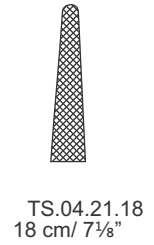

CRILE WOOD "TC"  
(DEBAKEY "TC")

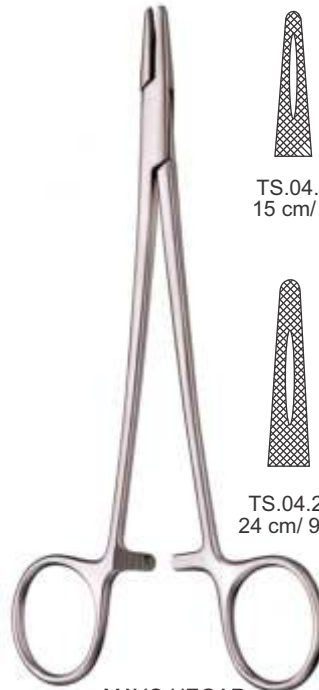

MAYO HEGAR

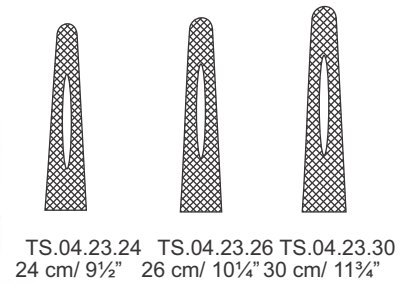
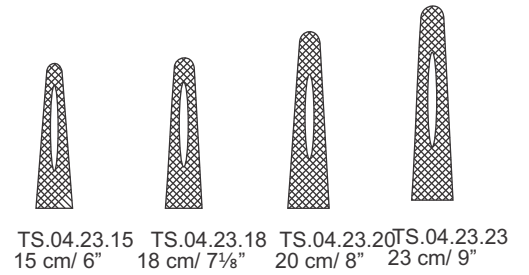

# Needle Holders

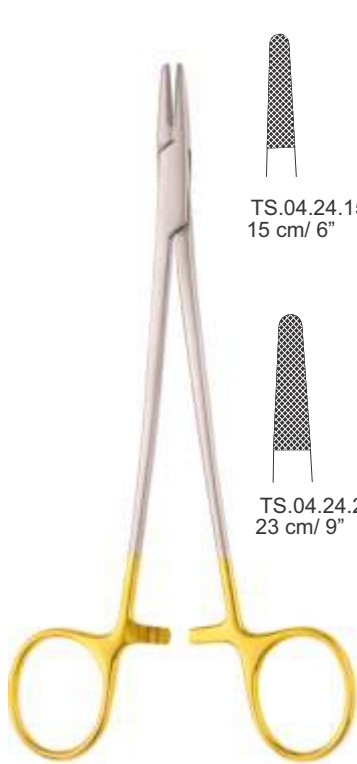

MAYO HEGAR "TC"

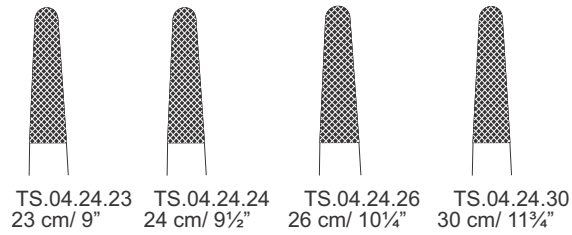
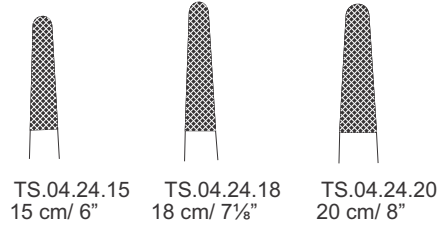

HEGAR "TC"  
TS.04.25.71  
20.5 cm / 8½"



HEGAR

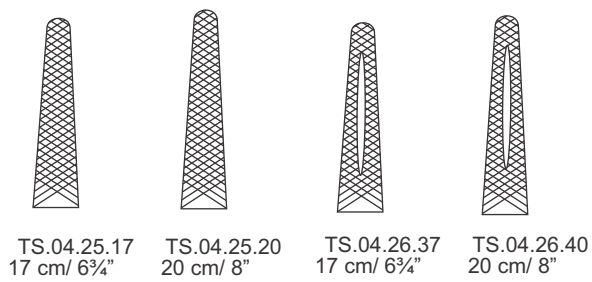

# Needle Holders



TS.04.27.65  
15 cm/ 6"

TS.04.27.64  
18 cm/ 7 1/8"

TS.04.28.20  
20 cm/ 8"

TS.04.29.20  
20 cm/ 8"

TS.04.27.70  
20 cm/ 8"

TS.04.27.71  
23 cm/ 9"

TS.04.28.23  
23 cm/ 9"

TS.04.29.23  
23 cm/ 9"

MICRO SLIM "TC"

JULIAN

JULIAN "TC"

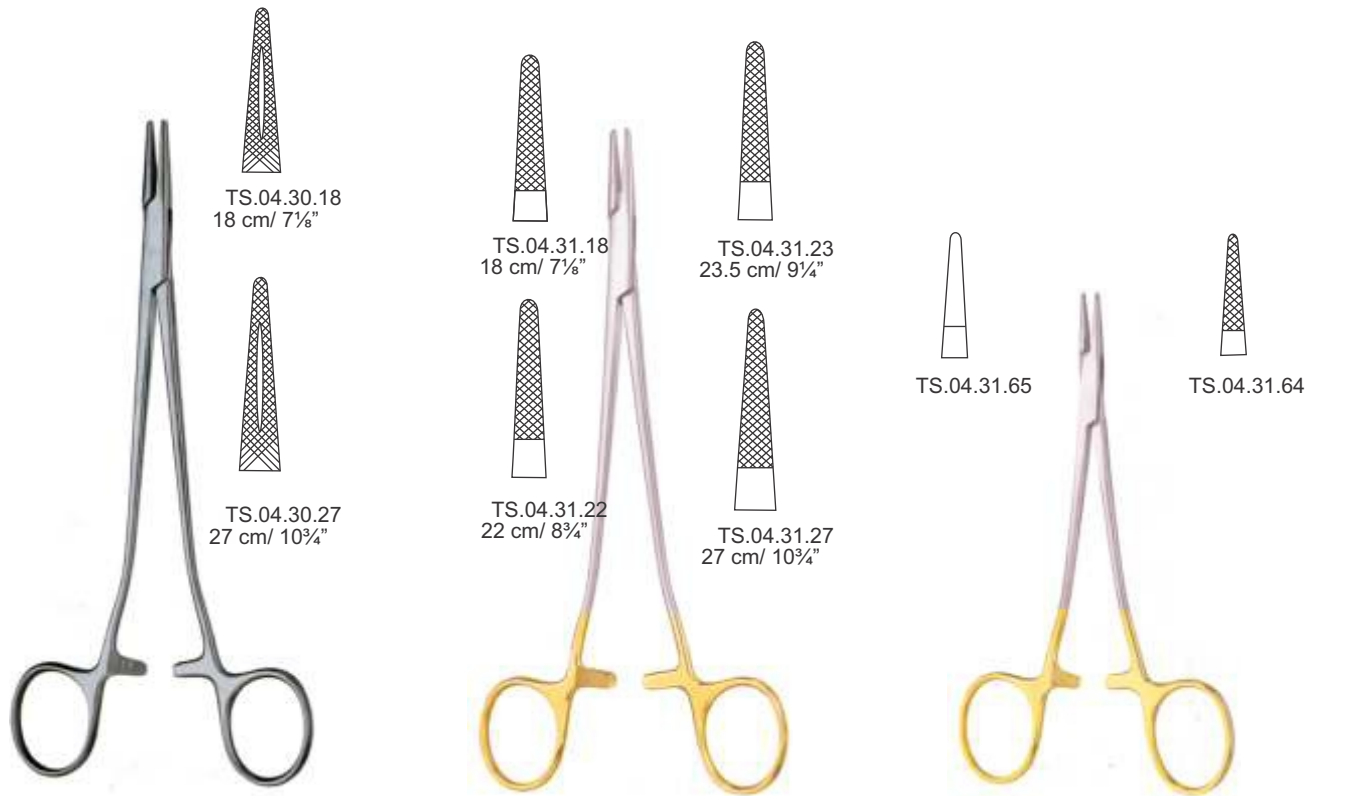

TS.04.30.18  
18 cm/ 7 1/8"

TS.04.31.18  
18 cm/ 7 1/8"

TS.04.31.23  
23.5 cm/ 9 1/4"

TS.04.31.65

TS.04.31.64

TS.04.30.27  
27 cm/ 10 3/4"

TS.04.31.22  
22 cm/ 8 3/4"

TS.04.31.27  
27 cm/ 10 3/4"

SAROT

SAROT "TC"

INTRACARDIAC "TC"  
14 cm/ 5 1/2"



# Needle Holders



BABY CRILE WOOD  
TS.04.32.15  
15 cm / 6"



CRILE MURRAY  
TS.04.32.45  
15 cm / 6"



BABY CRILE WOOD "TC"  
TS.04.33.15  
15 cm / 6"



CRILE WOOD  
TS.04.34.15  
15 cm / 6"



CRILE WOOD "TC"  
TS.04.35.15  
15 cm / 6"



ADSON  
TS.04.36.17  
18 cm / 7 1/8"



METZENBAUM HEGAR  
TS.04.37.18  
18 cm / 7 1/8"



HEANEY  
TS.04.38.21  
21 cm / 8 1/4"

# Needle Holders



HEANEY "TC"  
TS.04.39.21  
21 cm / 8 1/4"



STRATTE "TC"  
TS.04.41.20 20 cm / 8"  
TS.04.41.24 24 cm / 9 1/2"



RYDER (FRENCH EYE) "TC"

TS.04.42.13 13 cm / 5 1/8"  
TS.04.42.15 15 cm / 6"  
TS.04.42.18 18 cm / 7 1/8"

TS.04.42.20 20 cm / 8"  
TS.04.42.23 23 cm / 9"  
TS.04.42.26 25 cm / 10"

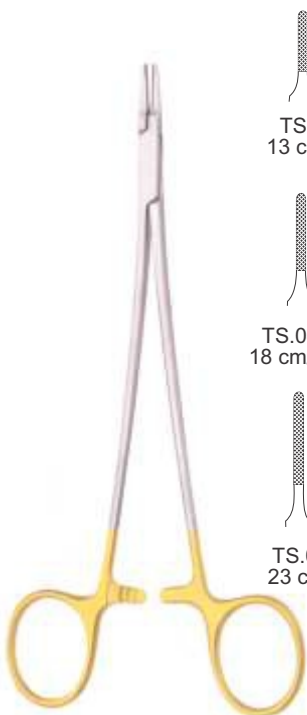

MINI RYDER "TC"  
VASCULAR

TS.04.44.13 13 cm / 5 1/8"  
TS.04.44.15 15 cm / 6"

TS.04.44.18 18 cm / 7 1/8"  
TS.04.44.20 20 cm / 8"

TS.04.44.23 23 cm / 9"  
TS.04.44.26 26 cm / 10 1/4"

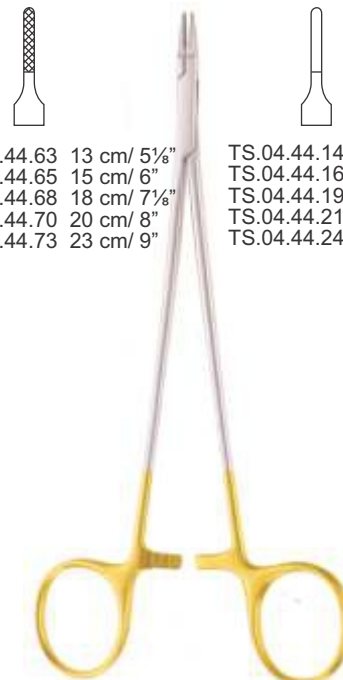

RYDER SLIM "TC"

TS.04.44.63 13 cm / 5 1/8"  
TS.04.44.65 15 cm / 6"  
TS.04.44.68 18 cm / 7 1/8"  
TS.04.44.70 20 cm / 8"  
TS.04.44.73 23 cm / 9"  
TS.04.44.14 13 cm / 5 1/8"  
TS.04.44.16 15 cm / 6"  
TS.04.44.19 18 cm / 7 1/8"  
TS.04.44.21 20 cm / 8"  
TS.04.44.24 23 cm / 9"

# Needle Holders

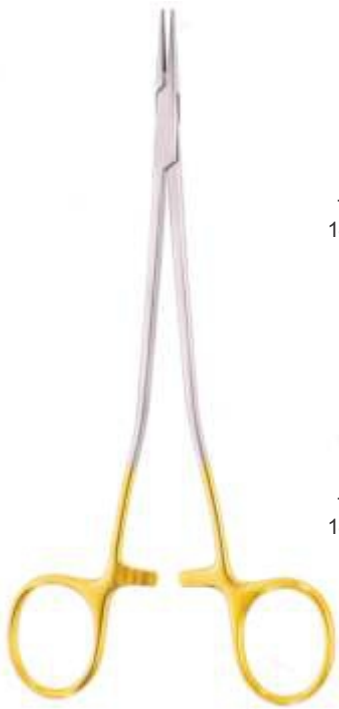

MICROVASCULAR "TC"

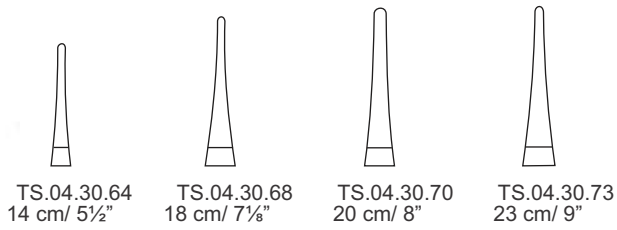
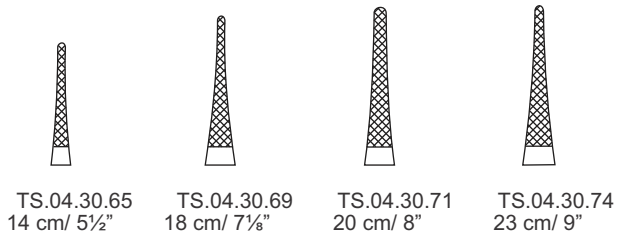

extremely delicate



TS.04.45.15 15 cm/ 6"  
TS.04.45.17 17 cm/ 6¾"



SENNING "TC"



TS.04.45.16 15 cm/ 6"  
TS.04.45.18 17 cm/ 6¾"



SENNING  
TS.04.46.17  
17 cm/ 6¾"

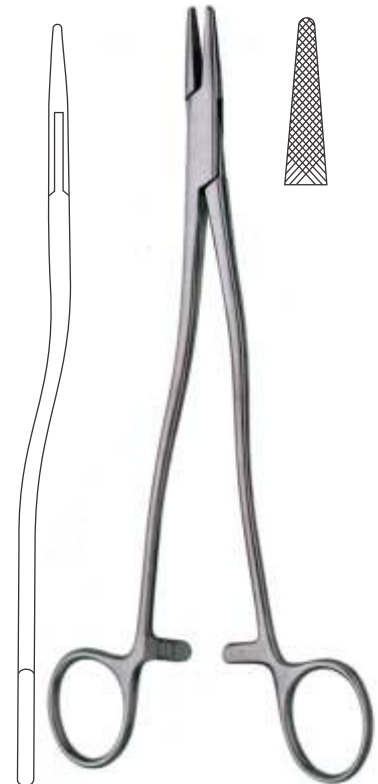

THOMSON WALKER  
(BOZEMANN)  
TS.04.47.20  
20 cm/ 8"

# Needle Holders

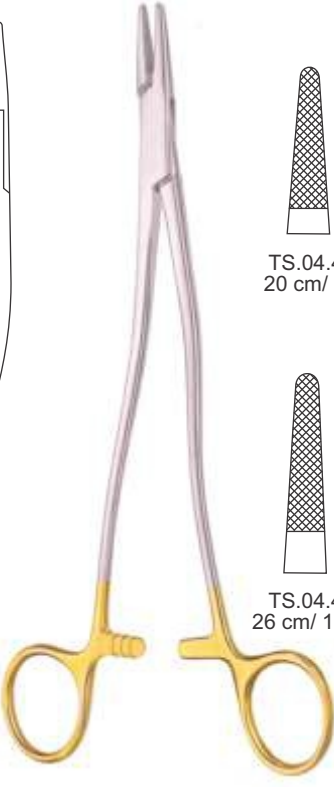

**BOZEMANN  
(WERTHEIM) "TC"**

TS.04.48.20  
20 cm / 8"

TS.04.48.24  
24 cm / 9½"

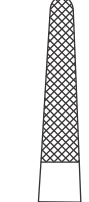
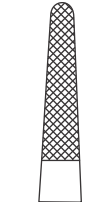
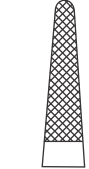

TS.04.48.26  
26 cm / 10¼"

TS.04.48.30  
30 cm / 11¾"



**MASSON  
TS.04.49.27  
27 cm / 10¾"**



**MASSON "TC"  
TS.04.50.27  
27 cm / 10¾"**



**WANGENSTEEN  
TS.04.51.28  
28 cm / 11"**



**WANGENSTEEN "TC"  
TS.04.52.28  
28 cm / 11"**

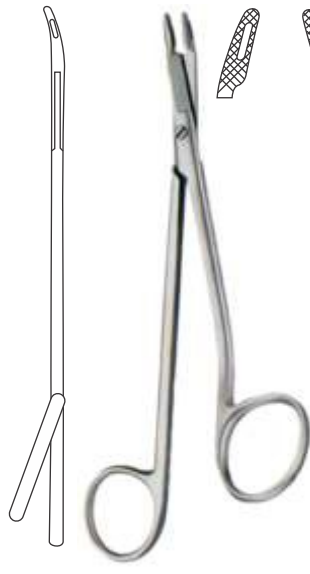

**GILLIES SLIM  
TS.04.53.14  
14.5 cm / 5¾"**

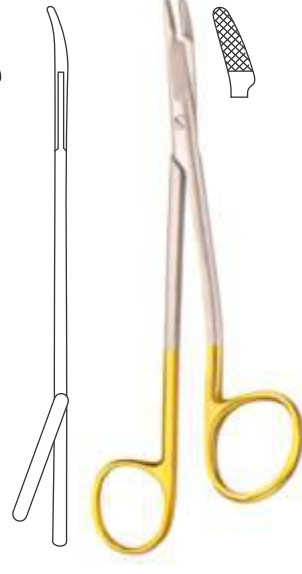

**GILLIES SLIM "TC"  
TS.04.54.15  
14.5 cm / 5¾"**

# Needle Holders

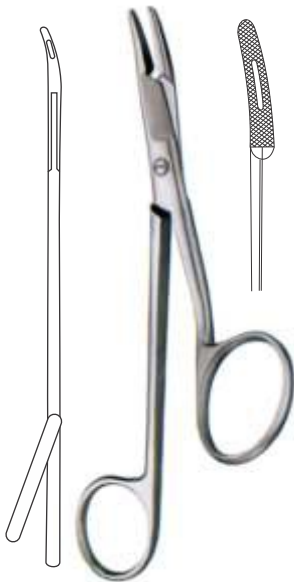

GILLIES  
TS.04.55.15  
15 cm/ 6"

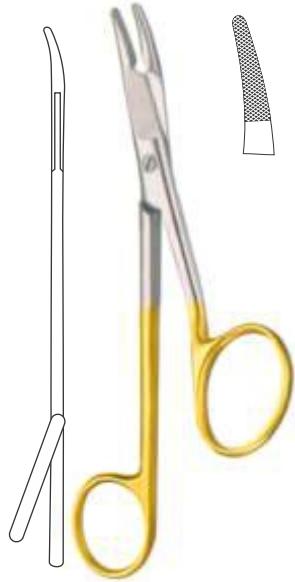

GILLIES "TC"  
TS.04.56.16  
15 cm/ 6"



FINOCHIETTO  
TS.04.57.27  
27 cm/ 10 3/4"



FINOCHIETTO "TC"  
TS.04.58.27  
27 cm/ 10 3/4"



KILNER  
TS.04.59.13  
13 cm/ 5 1/8"

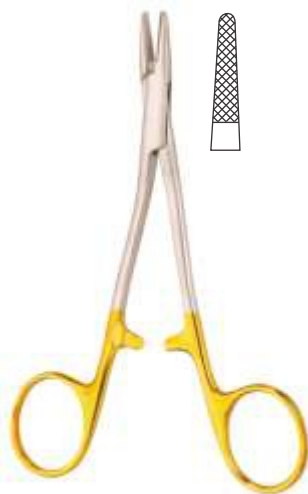

KILNER "TC"  
TS.04.60.13  
13 cm/ 5 1/8"



OLSEN HEGAR MINI  
12 cm/ 4 3/4"

TS.04.61.12

TS.04.61.13



OLSEN HEGAR MINI  
"TC"  
12 cm/ 4 3/4"

TS.04.62.12

TS.04.62.13

# Needle Holders



OLSEN HEGAR

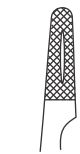

TS.04.63.14  
14 cm / 5½"



TS.04.63.17  
17 cm / 6¾"



TS.04.63.19  
19 cm / 7½"



OLSEN HEGAR "TC"



TS.04.64.14  
14 cm / 5½"



TS.04.64.17  
17 cm / 6¾"



TS.04.64.19  
19 cm / 7½"



MATHIEU KOCHER



TS.04.65.14  
14 cm / 5½"



TS.04.65.17  
17 cm / 6¾"



TS.04.65.20  
20 cm / 8"



MATHIEU KOCHER "TC"



TS.04.66.14  
14 cm / 5½"



TS.04.66.17  
17 cm / 6¾"



TS.04.66.20  
20 cm / 8"

# Needle Holders



MATHIEU

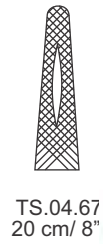
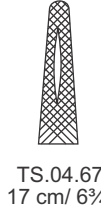
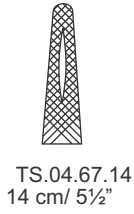

MATHIEU

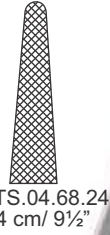
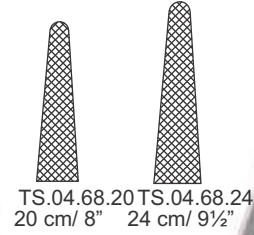
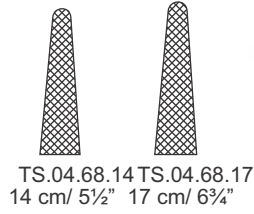

MATHIEU "TC"

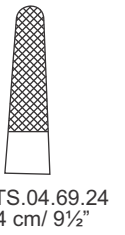
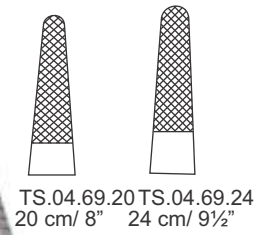
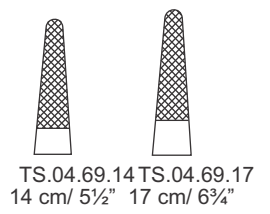

MATHIEU  
TS.04.70.13  
14 cm/ 5½"



MATHIEU

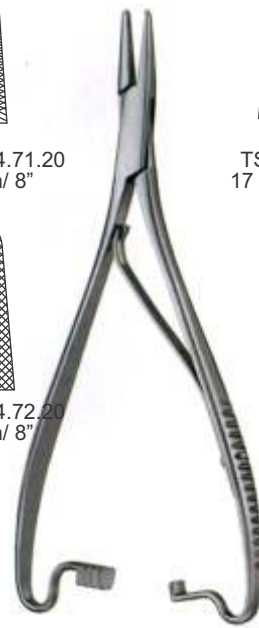
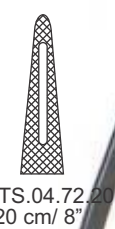
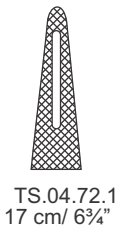
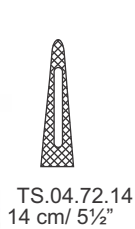
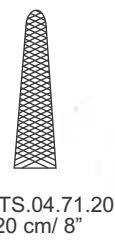
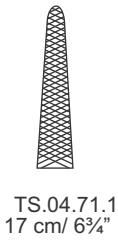
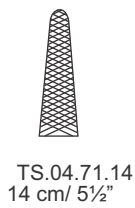

MATHIEU

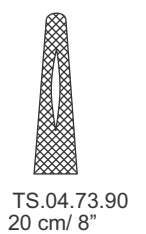
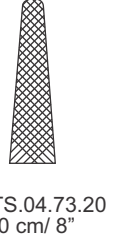
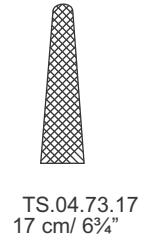

# Needle Holders



TS.04.74.14  
 14 cm/ 5½"

TS.04.74.17  
 17 cm/ 6¾"

TS.04.74.20  
 20 cm/ 8"



TS.04.76.20  
 20 cm/ 8"

TS.04.76  
 23 cm/ 9"



TS.04.77.20 TS.04.77.23  
 20 cm/ 8" 23 cm/ 9"



TS.04.79.20  
 20 cm/ 8"

TS.04.79.25  
 25 cm/ 10"



TS.04.81.17  
 17 cm/ 6¾"

TS.04.81.20  
 20 cm/ 8"

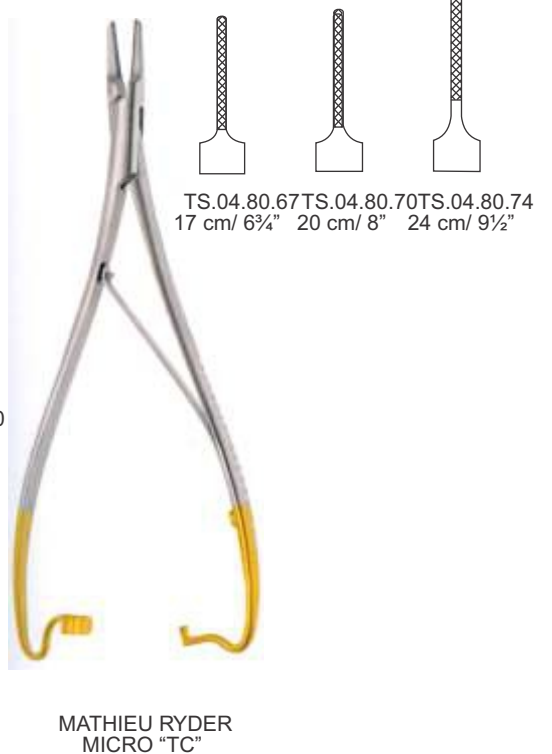

TS.04.80.67 TS.04.80.70 TS.04.80.74  
 17 cm/ 6¾" 20 cm/ 8" 24 cm/ 9½"



# Needle Holders



TS.04.82.70  
20 cm/ 8"



TS.04.82.75  
25 cm/ 10"

LICHTENBERG "TC"



TS.04.83.16  
16 cm/ 6¼"



TS.04.83.18  
18 cm/ 7⅛"



TS.04.83.20  
20 cm/ 8"

LANGENBECK



TS.04.84.16  
16 cm/ 6¼"



TS.04.84.18  
18 cm/ 7⅛"



TS.04.84.20  
20 cm/ 8"

LANGENBECK "TC"



CRILE  
TS.04.85.15  
15 cm/ 6"



TOENNIS  
TS.04.86.18  
18 cm/ 7⅛"

# Needle Holders



TOENNIS "TC"



TS.04.87.16  
16 cm / 6¼"



TS.04.87.18  
18 cm / 7⅛"



TS.04.88.20  
20 cm / 8"



BOYNTON  
TS.04.91.12  
12 cm / 4¾"



BOYNTON "TC"  
TS.04.92.12  
12 cm / 4¾"



JACOBSON



TS.04.101.18  
18.5 cm / 7¼"

TS.04.101.21  
21 cm / 8¼"

with catch



JACOBSON "TC"



TS.04.102.18  
18.5 cm / 7¼"

TS.04.102.21  
21 cm / 8¼"

with catch



JACOBSON "TC"



TS.04.102.19  
18.5 cm / 7¼"

TS.04.102.20  
21 cm / 8¼"

# Needle Holders



TS.04.102.22 TS.04.102.23

JACOBSON "TC"  
18 cm / 7<sup>1</sup>/<sub>8</sub>"



TS.04.102.24 TS.04.102.25

JACOBSON "TC"  
18 cm / 7<sup>1</sup>/<sub>8</sub>"



TS.04.103.12 12 cm / 4 <sup>3</sup> / <sub>4</sub> "	TS.04.104.12 12 cm / 4 <sup>3</sup> / <sub>4</sub> "
TS.04.103.14 14 cm / 5 <sup>1</sup> / <sub>2</sub> "	TS.04.104.15 14 cm / 5 <sup>1</sup> / <sub>2</sub> "
TS.04.103.17 17 cm / 6 <sup>3</sup> / <sub>4</sub> "	TS.04.104.18 17 cm / 6 <sup>3</sup> / <sub>4</sub> "

with catch

CASTROVIEJO



with catch

CASTROVIEJO  
TS.04.103.34 14 cm / 5<sup>1</sup>/<sub>2</sub>"  
TS.04.103.37 17 cm / 6<sup>3</sup>/<sub>4</sub>"

TS.04.105.14  
14 cm / 5<sup>1</sup>/<sub>2</sub>"

TS.04.105.16  
17 cm / 6<sup>3</sup>/<sub>4</sub>"



TS.04.105.15  
14 cm / 5<sup>1</sup>/<sub>2</sub>"

TS.04.105.17  
17 cm / 6<sup>3</sup>/<sub>4</sub>"

CASTROVIEJO "TC"

# Needle Holders

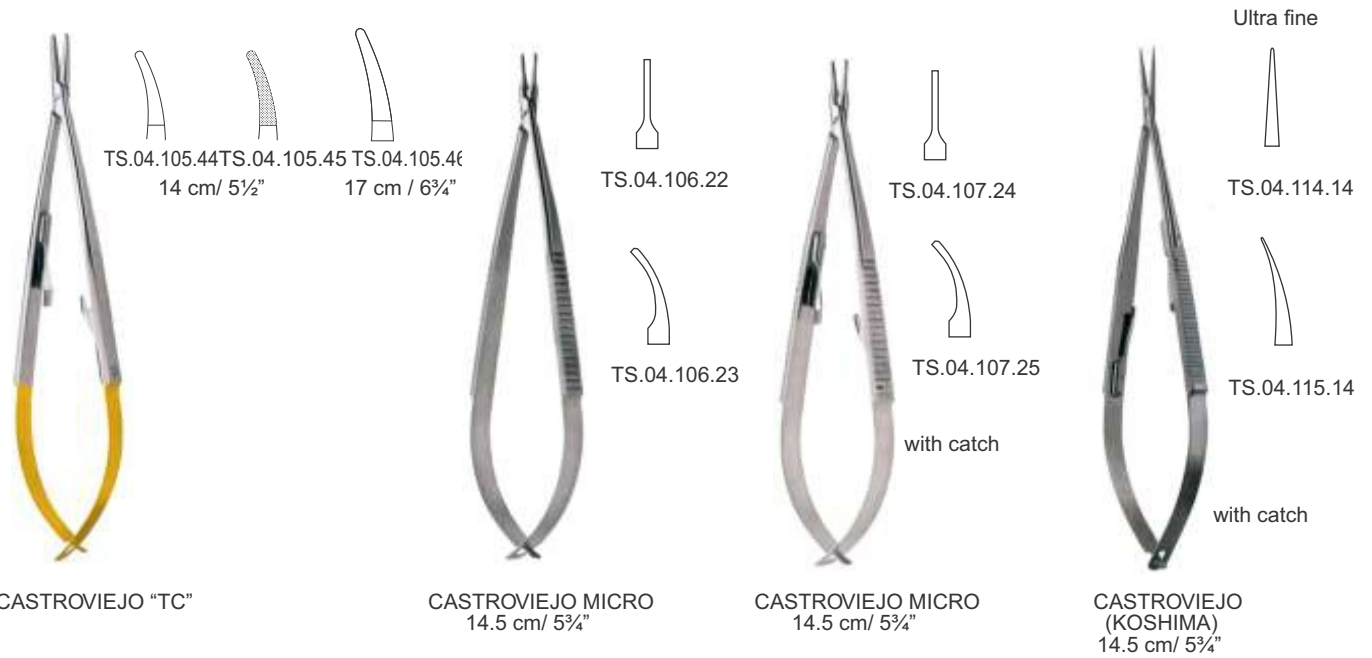

# Bandage Instruments



Bandage Instruments

# Bandage Instruments



LORENZ  
 TS.04.01.24  
 24 cm / 9½"

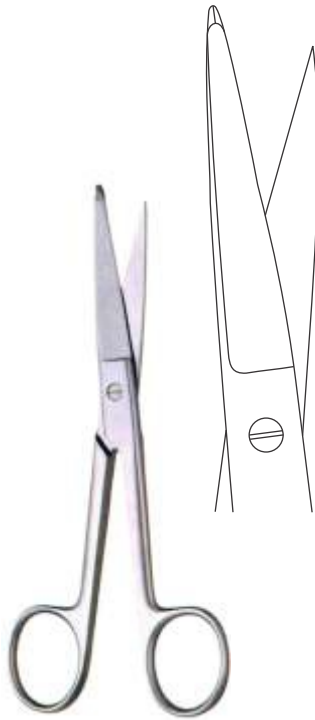

KNOWLES  
 TS.04.02.14  
 14 cm / 5½"

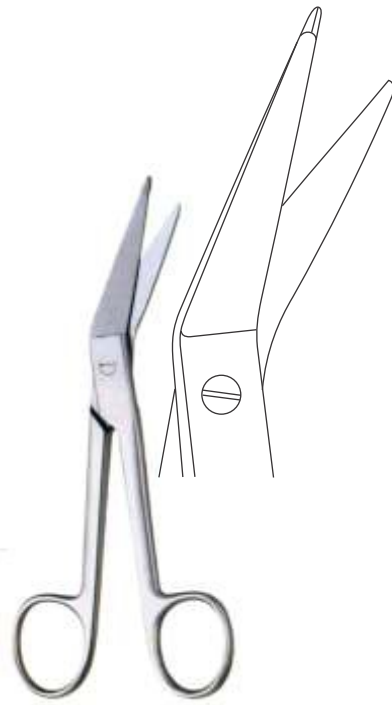

KNOWLES  
 TS.04.03.84  
 14 cm / 5½"



ESMARCH

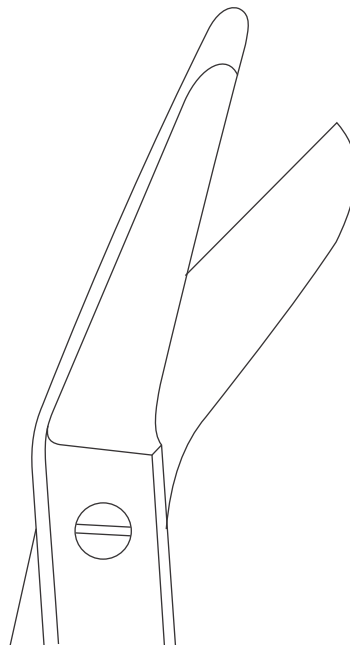

20 cm / 8"  
 Standard  
 TS.04.04.20

Supercut  
 TS.04.04.120

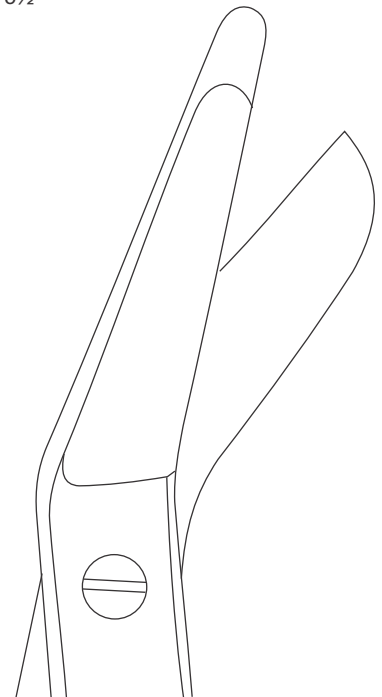

22 cm / 8¾"  
 Standard  
 TS.04.04.22

# Bandage Instruments

UNIVERSAL

14 cm/ 5½"  
Black TS.04.08.14

14 cm/ 5½"  
Black TS.04.08.15  
Blue TS.04.08.15 BL  
Red TS.04.08.15 RD  
Yellow TS.04.08.15 YL  
Orange TS.04.08.15 OR  
Pink TS.04.08.15 PK

18 cm/ 7¼"  
Black TS.04.08.18  
Blue TS.04.08.18 BL  
Red TS.04.08.18 RD  
Yellow TS.04.08.18 YL  
Orange TS.04.08.18 OR  
Pink TS.04.08.18 PK



BERGMANN  
TS.04.05.23  
23 cm/ 9"



BRUNS  
23 cm/ 9"  
standard TS.04.07.24  
TC TS.04.07.74  
supercut TS.04.07.124



BRUNS  
TS.04.06.23  
24 cm/ 9½"

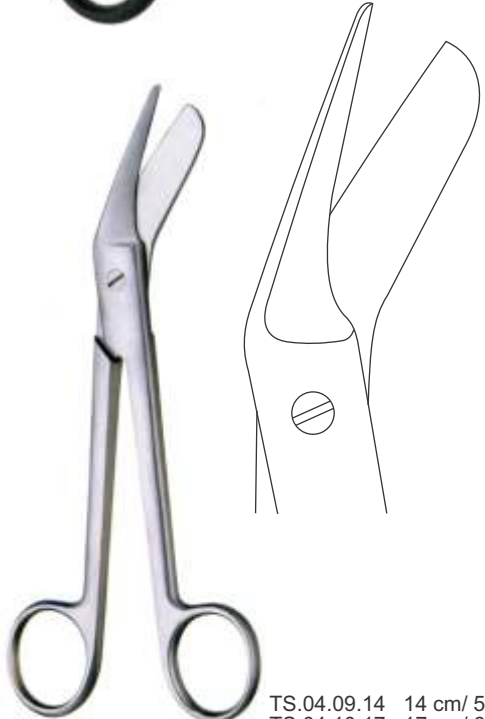

TS.04.09.14 14 cm/ 5½"  
TS.04.10.17 17 cm/ 6¾"

# Bandage Instruments



TS.04.11.15  
15 cm/ 6"



LISTER

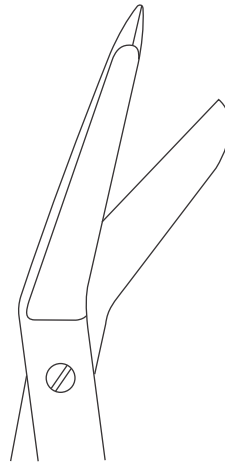

	standard	"TC"	supercut
9 cm/ 3½"	TS.04.12.09	TS.04.12.59	
11.5 cm/ 3½"	TS.04.12.11	TS.04.12.61	
14 cm/ 5½"	TS.04.12.14	TS.04.12.64	TS.04.12.114
16 cm/ 6¼"	TS.04.12.16	TS.04.12.66	TS.04.12.116
18 cm/ 7¼"	TS.04.12.18	TS.04.12.68	TS.04.12.118
20 cm/ 8"	TS.04.12.20	TS.04.12.70	TS.04.12.120



with big ring

SMITH  
TS.04.13.18  
18 cm/ 7¼"



LISTER  
standard TS.04.14.96  
supercut TS.04.14.196  
16 cm/ 6¼"



LISTER  
standard TS.04.17.20  
"TC" TS.04.17.80  
supercut TS.04.17.120  
20 cm/ 8"



TS.04.15.21  
21 cm/ 8¼"



SEUTIN  
TS.04.16.23  
23 cm/ 9"



# Mallets



Mallets

# Mallets



Ø 20mm

TS.04.01.17  
 16.5 cm / 6½"  
 100 g

solid head

TS.04.01.16  
 16.5 cm / 6½"  
 130 g

lead filled head



Ø 40 mm  
 570 g

BERGMANN (HIBBS)  
 TS.04.01.22  
 22.5 cm / 9"



Ø 40 mm  
 700 g

KIRK  
 TS.04.02.20  
 19.5 cm / 7¾"



Ø 25 mm  
 120 g  
 Ø 30 mm  
 200 g  
 Ø 35 mm  
 260 g

DOYEN  
 TS.04.03.01  
 21 cm / 8"

TS.04.03.02  
 21 cm / 8"

TS.04.03.03  
 21 cm / 8"



Ø 40 mm  
 770 g

OMBREDANNE  
 TS.04.03.23  
 23 cm / 9"



Ø 26 mm  
 300 g

Ø 28 mm  
 340 g

Ø 30 mm  
 350 g

WILLIGER  
 TS.04.04.01  
 24 cm

TS.04.04.02  
 24 cm

TS.04.04.03  
 25 cm

# Mallets

Ø 30 mm  
200 g



COLLIN (LUCAS)  
TS.04.05.20  
21 cm / 8¼"

Ø 42/30mm  
530 g



TS.04.05.24  
24 cm / 9½"

Ø 30 mm  
400 g



GERZOG  
TS.04.07.18  
18 cm / 7⅛"

Ø 28 mm  
450 g

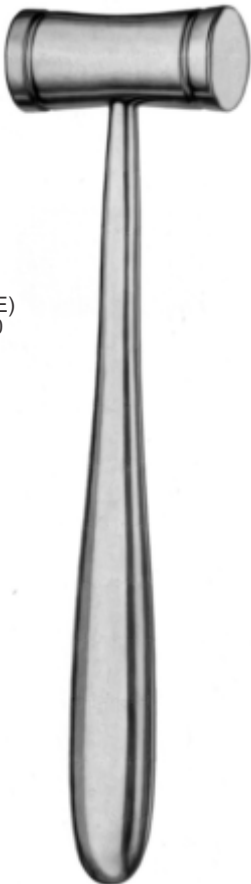

TS.04.05.23  
23 cm / 9"

Ø 26 mm  
300 g



TS.04.06.195  
spare facing

MEAD  
TS.04.06.19  
18 cm / 7⅛"

Ø 25 mm  
200 g



TS.04.08.185  
spare facing

TS.04.08.18  
18.5 cm / 7¼"

# Mallets



Ø 19 mm  
215 g

TS.04.09.19  
19 cm / 7½"



Ø 25 mm  
335 g

TS.04.10.25  
23 cm / 9"



Ø 37mm  
360 g

TS.04.10.34  
24 cm / 9½"

TS.04.10.134  
spare facing

# Mallets

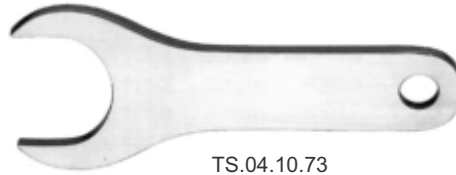

TS.04.10.73  
Wrench only



WAGNER  
TS.04.10.70



130 g

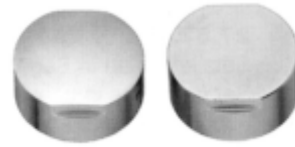

Ø 35 mm  
230 g  
TS.04.10.71  
Metal facing only

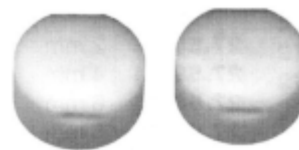

Ø 35 mm  
32 g  
TS.04.10.72  
Plastic facing only

# Mallets



TS.04.11.01  
 19 mm ø  
 230 gm (8 oz)

TS.04.11.02  
 25 mm ø  
 260 gm (9 oz)

2

LUCAE  
 19 cm 7 1/2"



30 mm ø  
 510 gm  
 (18 oz)

1/3

TS.04.12.22  
 26 cm 10 1/2"



Ø 30mm  
 215 g

TS.04.12.24  
 24 cm/ 9 1/2"



TS.04.14.35 Ø 35 mm, 150 g  
 TS.04.14.45 Ø 45 mm, 240 g  
 TS.04.14.50 Ø 50 mm, 330 g  
 26 cm/ 10 1/4"



Ø 26mm  
 200 g

HAJEK  
 TS.04.24.22  
 21 cm/ 8 1/4"

# Intestinal and Tissue Grasping Forceps

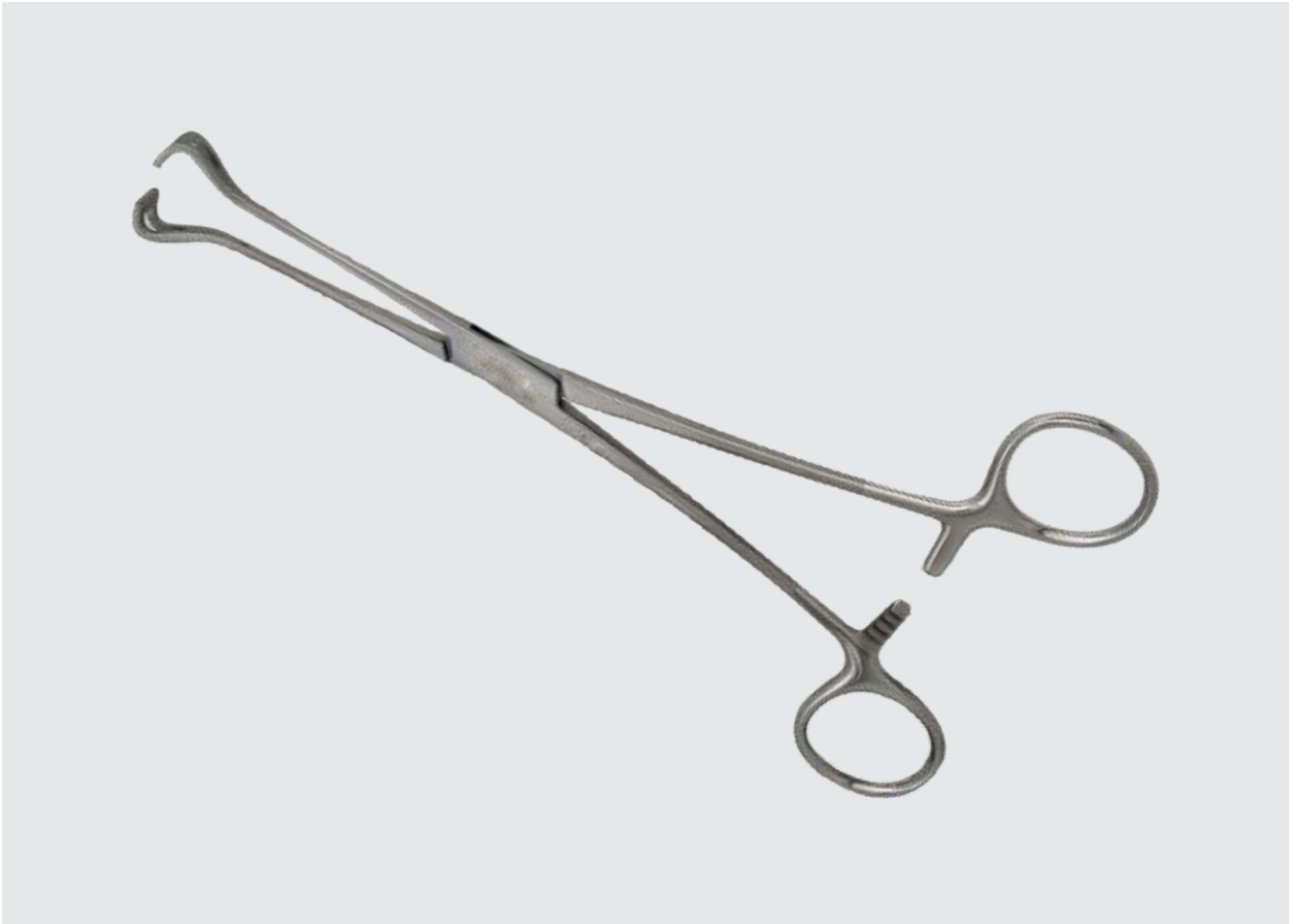

Intestinal and Tissue Grasping Forceps

# Intestinal and Tissue Grasping Forceps



ALLIS BABY  
TS.04.01.13 13 cm/ 5 1/8"  
TS.04.01.14 14 cm/ 5 1/2"



ALLIS  
TS.04.02.15 15 cm/ 6"  
TS.04.02.29 19 cm/ 7 1/2"



ALLIS  
TS.04.02.16 15 cm/ 6"  
TS.04.02.19 19 cm/ 7 1/2"  
TS.04.02.20 20 cm/ 8"  
TS.04.02.23 23 cm/ 9"



ALLIS-NIRO  
TS.04.03.85  
15 cm/ 6"

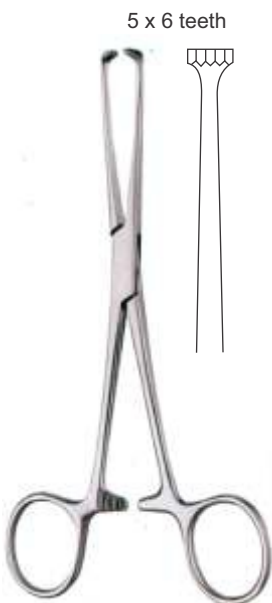

BOYS-ALLIS  
TS.04.04.15  
15 cm/ 6"



WILLIAMS  
TS.04.05.16  
16 cm/ 6 1/4"

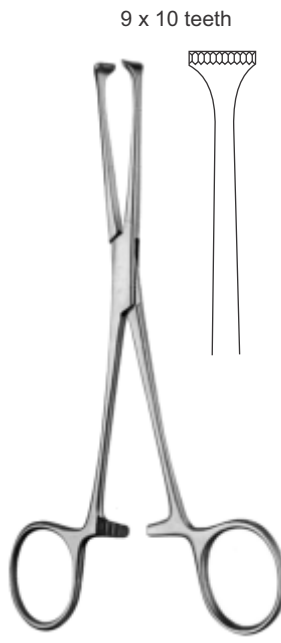

ADAIR-ALLIS  
TS.04.06.15  
15 cm/ 6"



THOMS-ALLIS  
TS.04.07.20  
20 cm/ 8"



# Intestinal and Tissue Grasping Forceps

4 x 5 teeth



**LOCKWOOD-ALLIS**  
TS.04.08.16  
16 cm / 6¼"

3 x 4 teeth

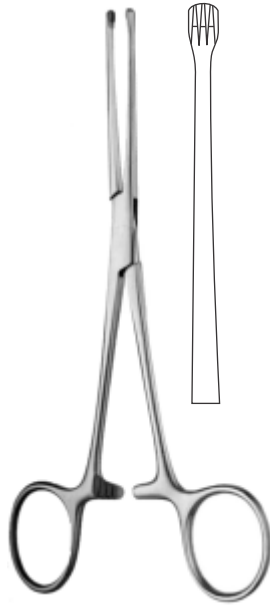

**JUDD-ALLIS**  
TS.04.09.65 15 cm / 6"  
TS.04.09.70 20 cm / 8"

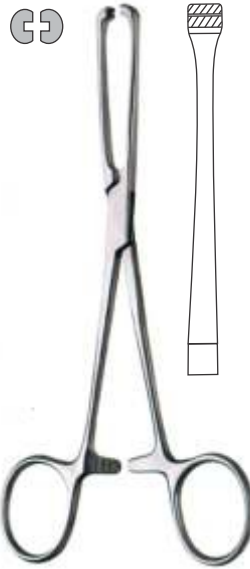

**ALLIS "AT"**  
TS.04.10.15 15.5 cm / 6⅛"  
TS.04.10.20 19 cm / 7½"



**ALLIS "AT"**  
TS.04.11.16 15.5 cm / 6⅛"  
TS.04.11.19 19 cm / 7½"  
TS.04.11.25 25.5 cm / 10"  
TS.04.11.30 30 cm / 12"



**BABCOCK-BABY**  
TS.04.12.16  
16 cm / 6¼"



**BABCOCK**

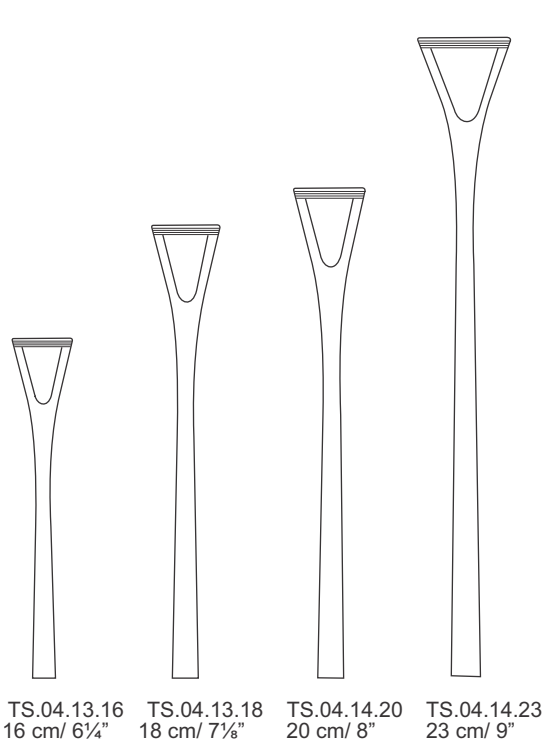

TS.04.13.16 16 cm / 6¼"  
TS.04.13.18 18 cm / 7⅛"  
TS.04.14.20 20 cm / 8"  
TS.04.14.23 23 cm / 9"

# Intestinal and Tissue Grasping Forceps



BABCOCK "AT"

BABCOCK "TC"

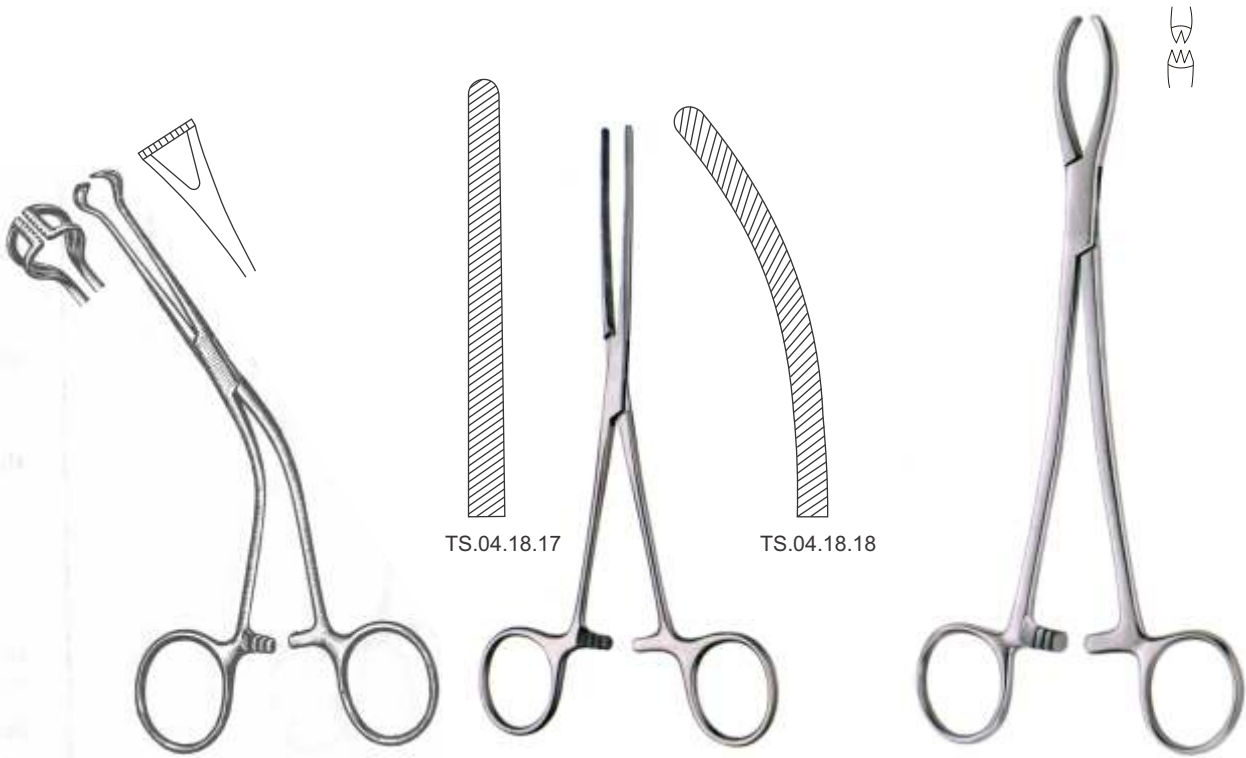

ALLIS-BABCOCK  
TS.04.17.86  
16 cm/ 6 1/4"

DOYEN-BABY  
17 cm/ 6 3/4"

LITTLEWOOD  
TS.04.19.18  
18.5 cm/ 7 1/4"

# Intestinal and Tissue Grasping Forceps



DOYEN-BABY "AT"

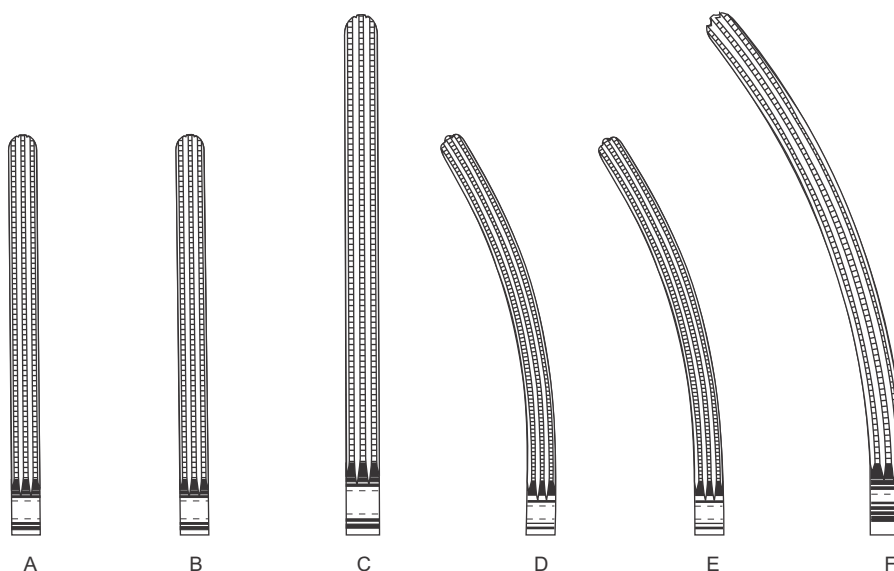

	13 cm / 5 1/8"	16 cm / 6 1/4"	18 cm / 7 1/8"
A	TS.04.19.63	B TS.04.19.67	C TS.04.19.69
D	TS.04.19.64	E TS.04.19.68	F TS.04.19.70

# Intestinal and Tissue Grasping Forceps



# Intestinal and Tissue Grasping Forceps

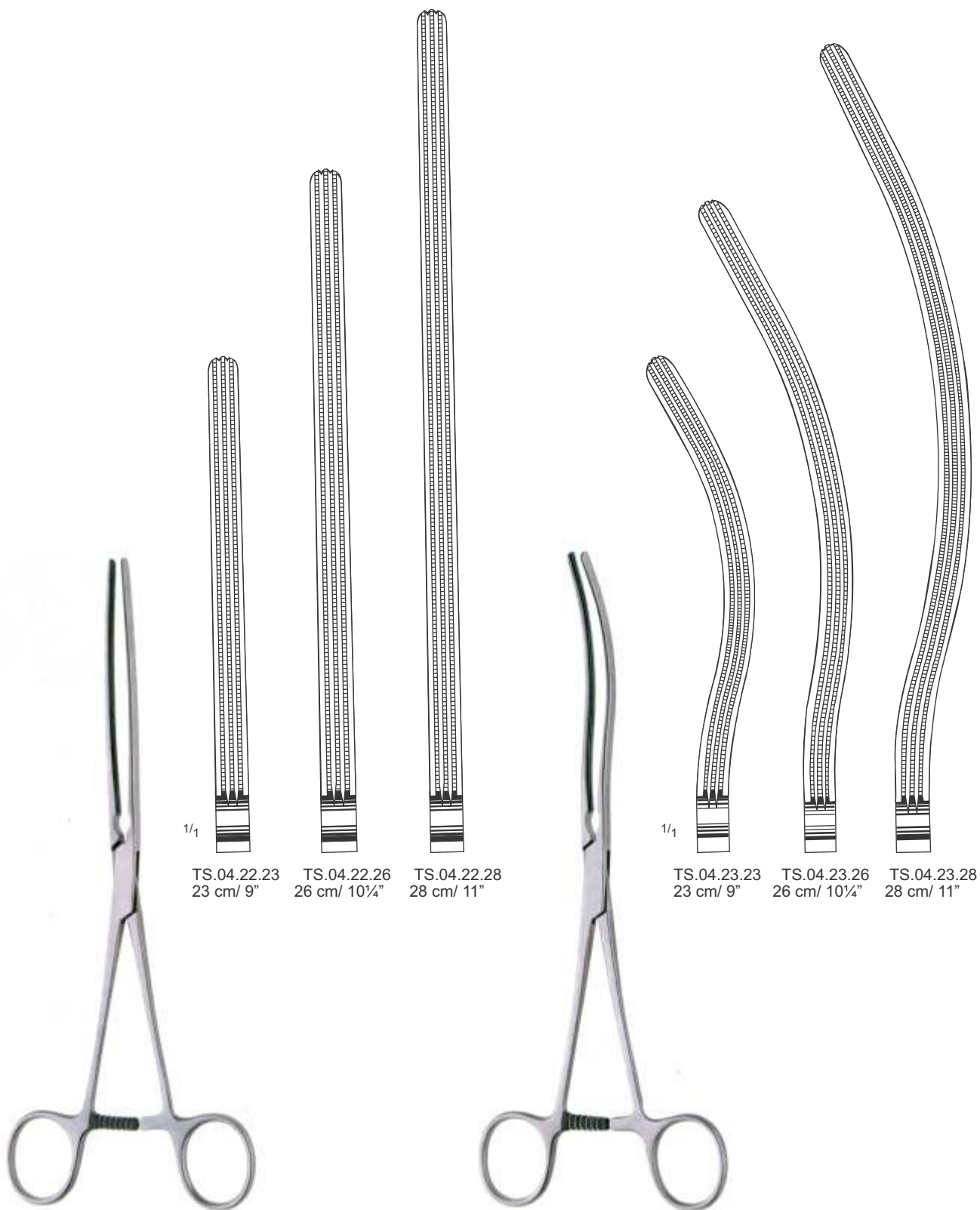

1/4

TS.04.22.23  
23 cm/ 9"

TS.04.22.26  
26 cm/ 10¼"

TS.04.22.28  
28 cm/ 11"

1/4

TS.04.23.23  
23 cm/ 9"

TS.04.23.26  
26 cm/ 10¼"

TS.04.23.28  
28 cm/ 11"

KOCHER "AT"

KOCHER "AT"

# Intestinal and Tissue Grasping Forceps

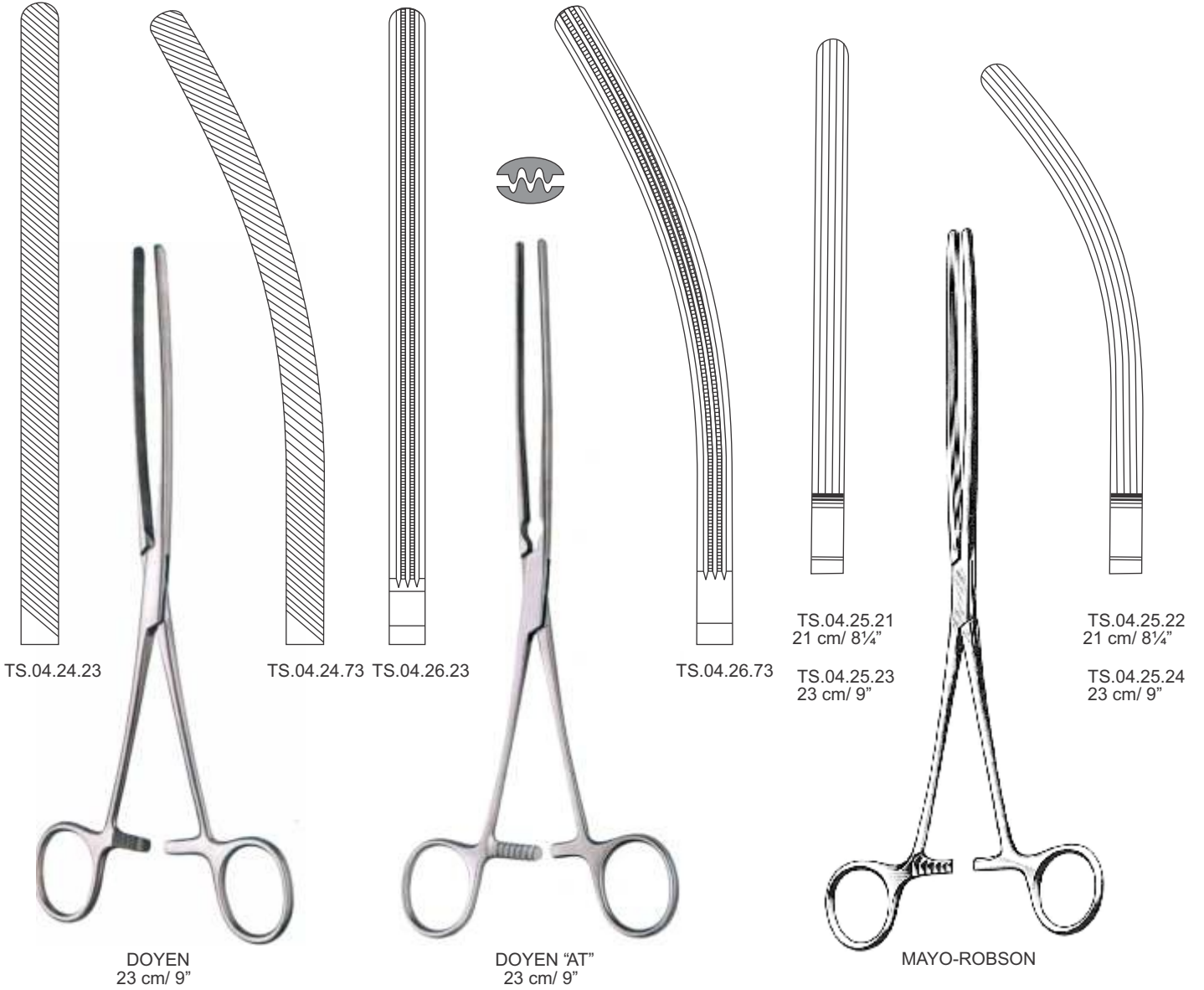

# Intestinal and Tissue Grasping Forceps

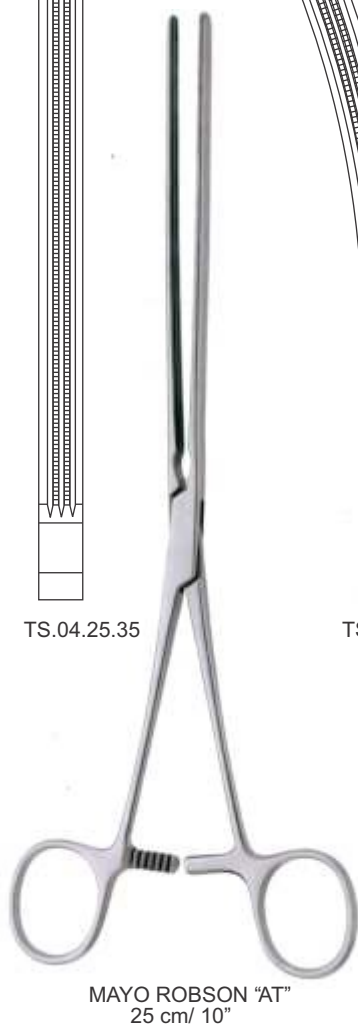
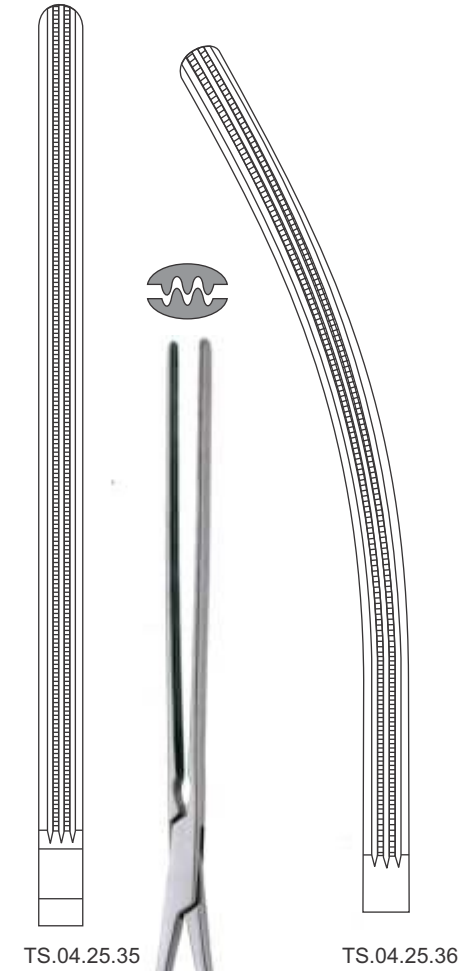
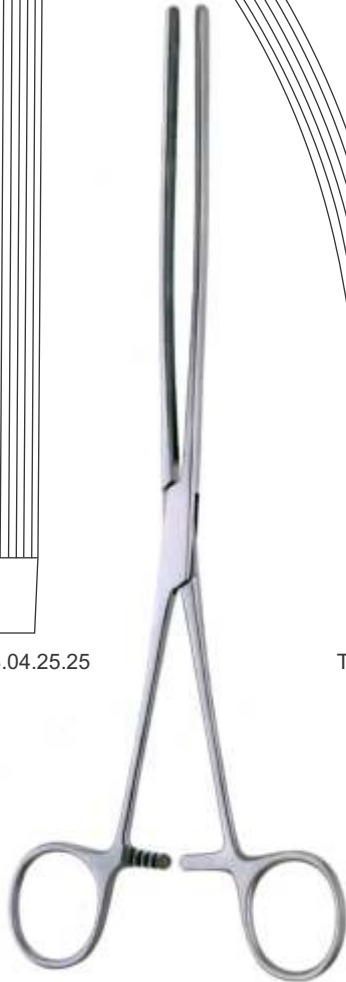
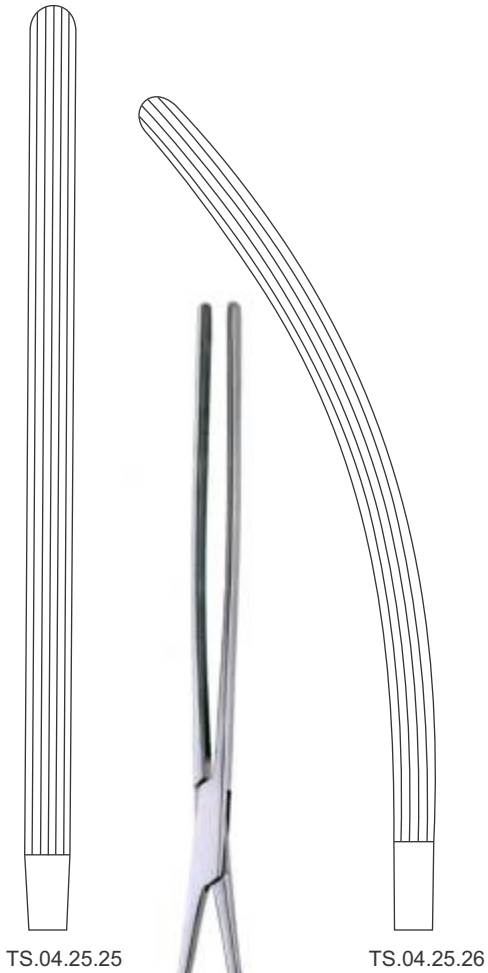

# Intestinal and Tissue Grasping Forceps

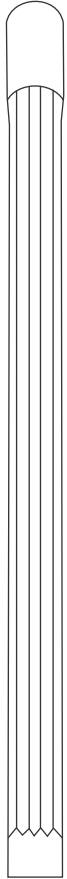

TS.04.27.25

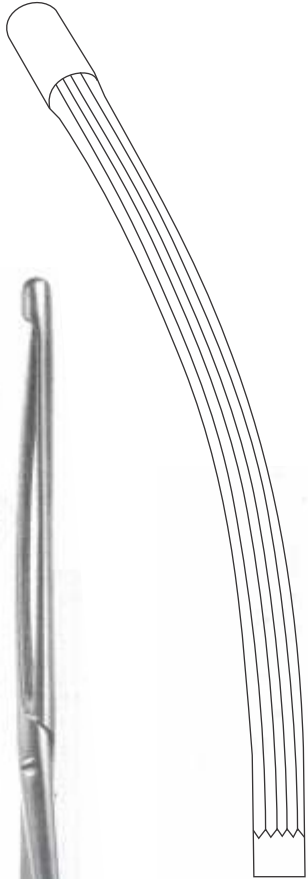

TS.04.27.26

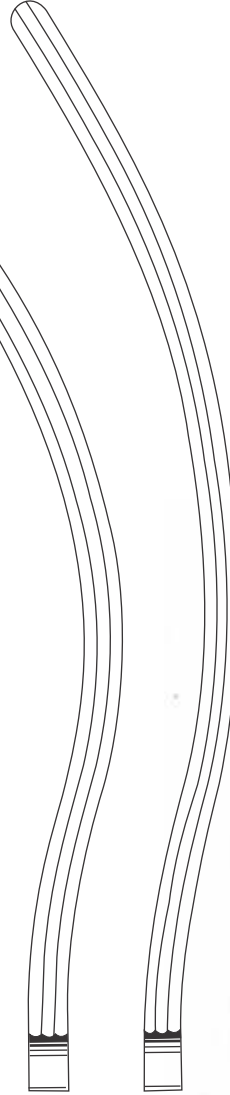

TS.04.28.24 24 cm / 9½"  
 TS.04.28.26 26 cm / 10¼"  
 TS.04.28.28 28 cm / 11"

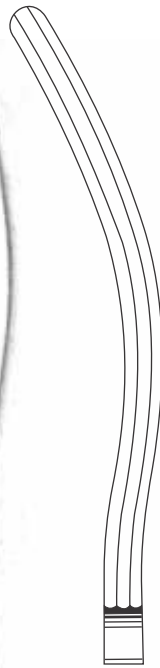

**NUSSBAUM**  
 25 cm / 10"

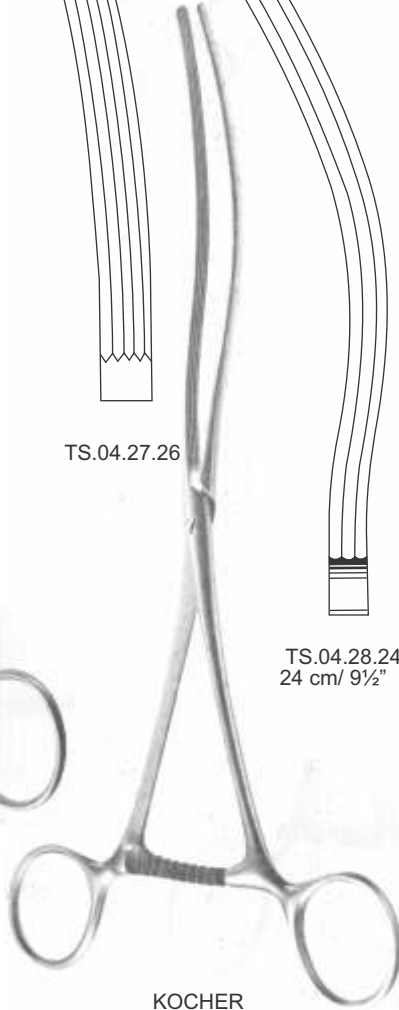

**KOCHER**

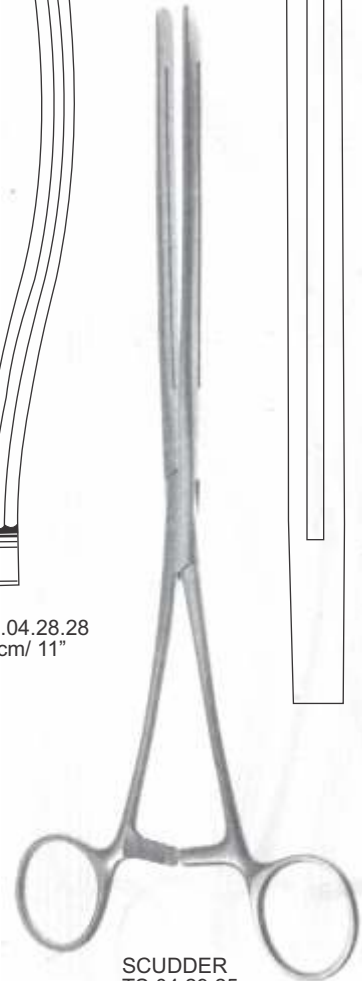

**SCUDDER**  
 TS.04.29.25  
 25 cm / 10"





# Intestinal and Tissue Grasping Forceps

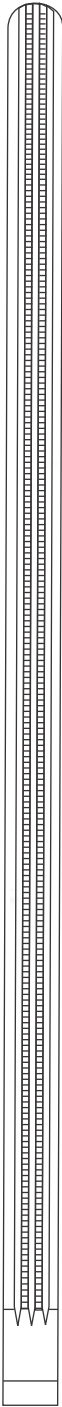

TS.04.29.33



SCUDDER "AT"  
33 cm / 13"

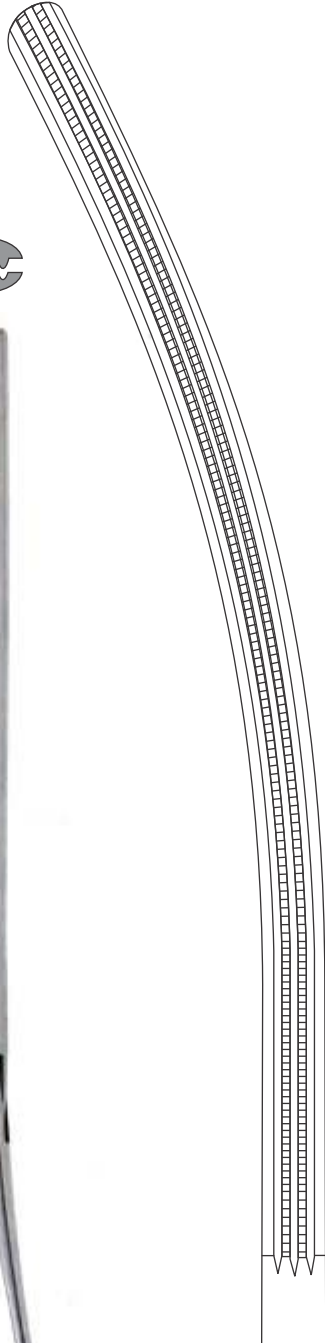

TS.04.29.34

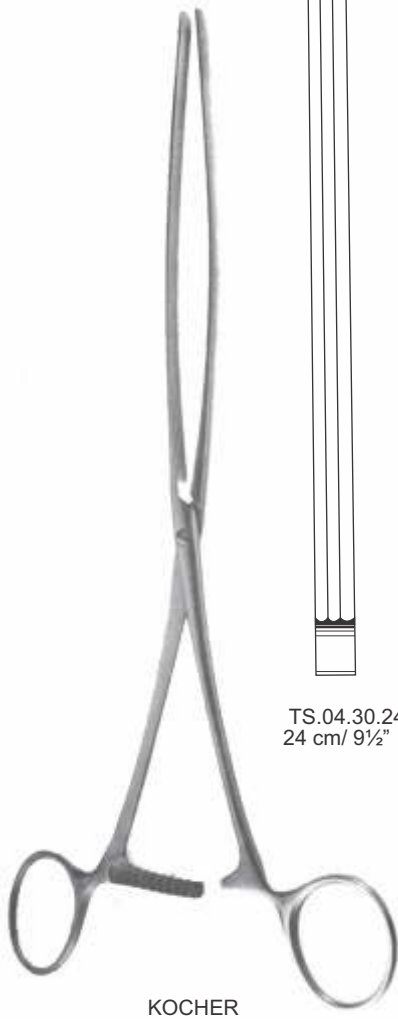

KOCHER



TS.04.30.24  
24 cm / 9½"



TS.04.30.26  
26 cm / 10¼"

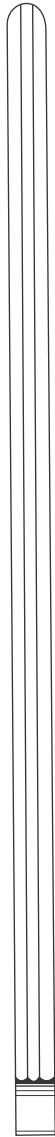

TS.04.30.28  
28 cm / 11"



# Intestinal and Tissue Grasping Forceps

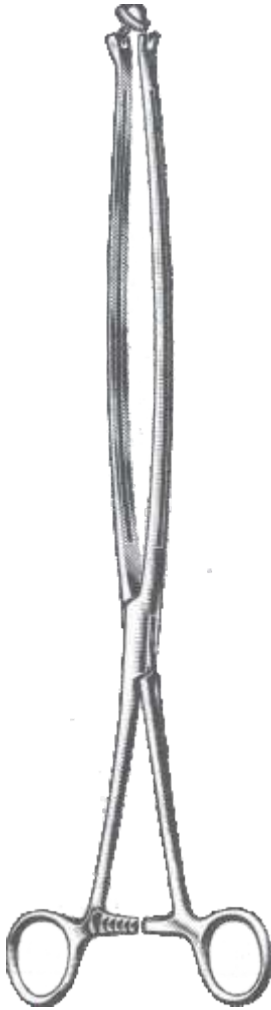

SCUDDER  
 TS.04.31.36  
 36 cm/ 14"



SCUDDER  
 TS.04.32.36  
 36 cm/ 14"

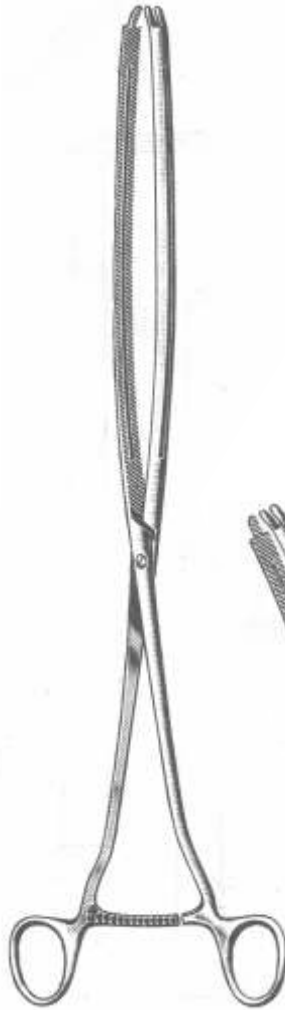

MOYNIHAN  
 TS.04.33.36  
 36 cm/ 14"



MOYNIHAN  
 TS.04.34.36  
 36 cm/ 14"

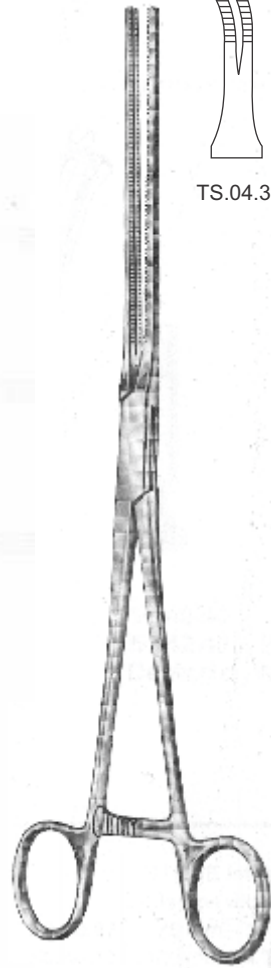

25 cm/ 10"

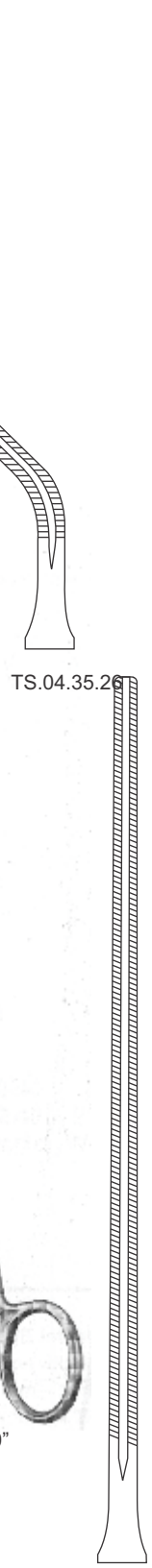

TS.04.35.26

TS.04.35.25

# Intestinal and Tissue Grasping Forceps

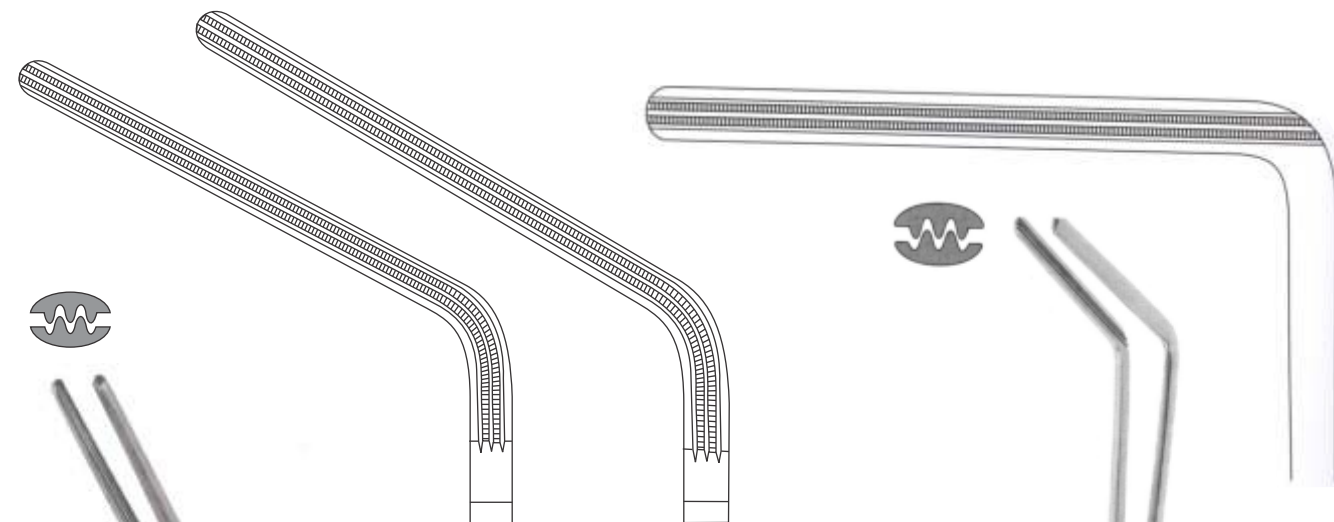

TS.04.35.40  
20 cm / 8"

TS.04.35.46  
26 cm / 10¼"



DEBAKEY "AT"

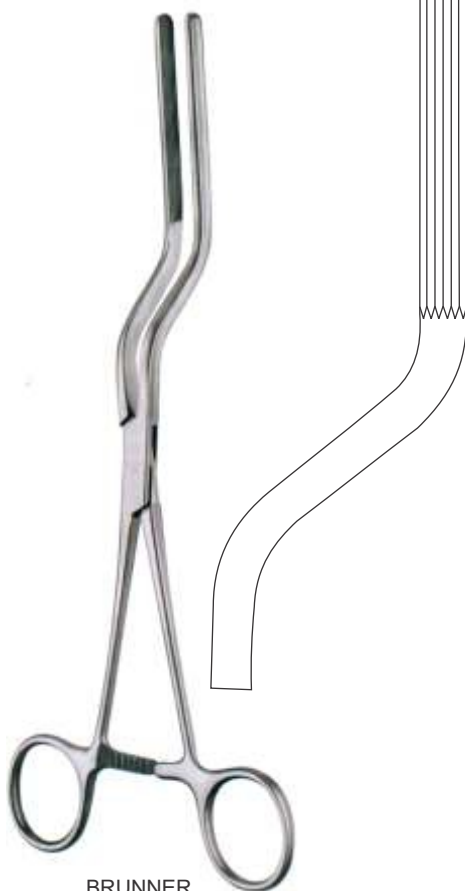

BRUNNER  
TS.04.36.24  
24 cm / 9½"



RESANO "AT"  
TS.04.36.28  
28 cm / 11"

# Intestinal and Tissue Grasping Forceps



KERSTING "AT"  
TS.04.36.30  
30 cm / 11¼"

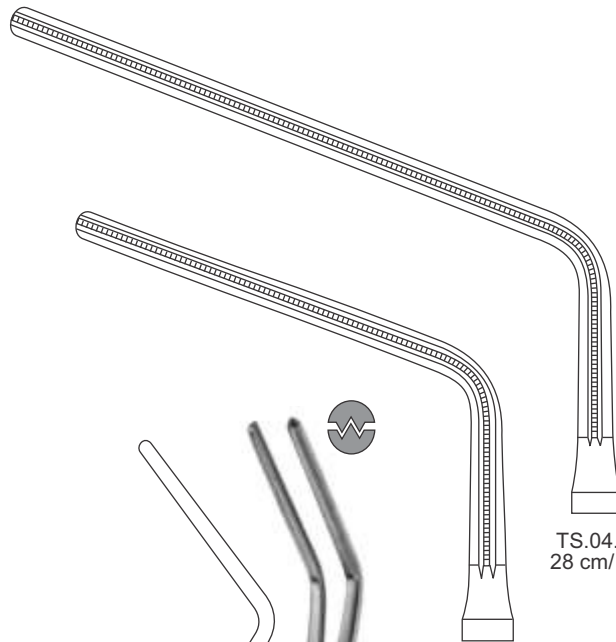

HAYES "AT"

TS.04.36.38  
28 cm / 11"

TS.04.36.37  
27 cm / 10¾"

# Intestinal and Tissue Grasping Forceps



# Intestinal and Tissue Grasping Forceps

With Pin



TS.04.42.14



**PAYR-BABY**  
 14.5 cm / 5¾"



TS.04.43.14



**PAYR**



TS.04.44.20  
 20 cm / 8"

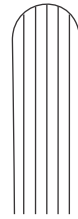

TS.04.44.28  
 28 cm / 11"

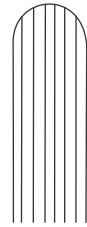

TS.04.44.35  
 35 cm / 13¾"

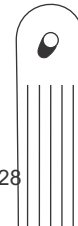

TS.04.45.20  
 20 cm / 8"



TS.04.45.28  
 28 cm / 11"

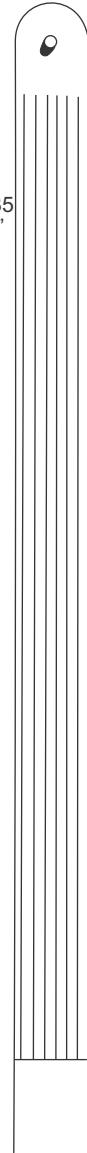

TS.04.45.35  
 35 cm / 13¾"

# Intestinal and Tissue Grasping Forceps



CZERNY  
TS.04.48.22  
22 cm/ 8<sup>3</sup>/<sub>4</sub>"



12/20 x 70 mm

RICORD  
TS.04.49.16  
16 cm/ 6<sup>1</sup>/<sub>4</sub>"



Pylorus spreader

BENSON  
TS.04.50.15  
15 cm/ 6"



BODENHAMMER (SIMS)  
TS.04.52.16  
16 cm/ 6<sup>1</sup>/<sub>4</sub>"



SIMS  
TS.04.53.16  
16 cm/ 6<sup>1</sup>/<sub>4</sub>"

# Intestinal and Tissue Grasping Forceps



DEMARTEL-WOLFSON  
 TS.04.54.05 50 mm  
 TS.04.54.07 75 mm  
 TS.04.54.10 100 mm

set of 3 pieces



DEMARTEL WOLFSON  
 TS.04.55.09 8,5 cm  
 TS.04.55.23 23 cm

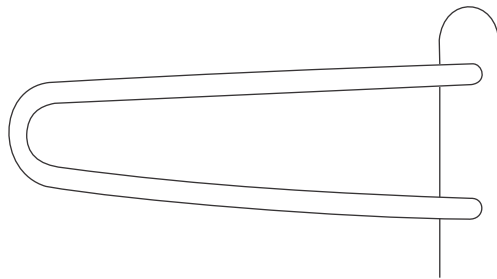

Blade Length  
 TS.04.56.17 17 cm 20 x 60 mm  
 TS.04.56.23 23 cm 23 x 80 mm  
 TS.04.56.24 23 cm 23 x 125 mm  
 TS.04.56.25 23 cm 23 x 150 mm



SIMS



# Intestinal and Tissue Grasping Forceps



PRATT  
TS.04.57.21  
21 cm / 8¼"



MATHIEU  
TS.04.58.21  
21 cm / 8¼"



BRINKERHOFF  
TS.04.59.13 Ø 13-25 x 90 mm  
TS.04.59.15 Ø 15-25 x 100 mm  
TS.04.59.19 Ø 19-32 x 115 mm



IVES-FANSLER  
TS.04.60.21  
Ø 21 x 85 mm



Sphincteroscopes

KELLY  
TS.04.61.25 Ø 25 x 50 mm  
TS.04.61.21 Ø 21 x 50 mm

# Intestinal and Tissue Grasping Forceps

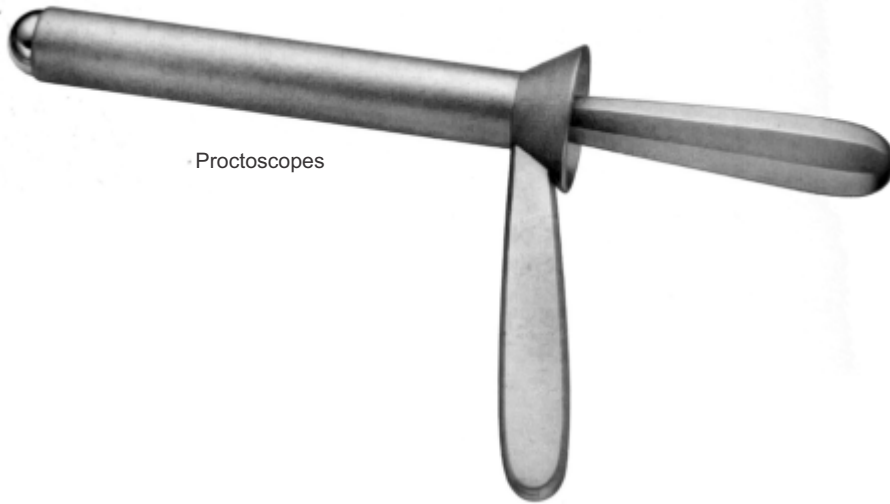

Proctoscopes

**KELLY**  
 TS.04.62.23 Ø 23 x 145 mm  
 TS.04.62.24 Ø 23 x 205 mm



**NEWMAN**  
 TS.04.63.01 – ø 16 mm x 63 mm  
 TS.04.63.02 – ø 19 mm x 63 mm  
 TS.04.63.03 – ø 23 mm x 63 mm



**BENSAUDE**  
 TS.04.63.19 Ø 19 x 70 mm  
 TS.04.63.22 Ø 22 x 70 mm



Anusscopes

**HIRSCHMANN**  
 TS.04.64.16 Ø 16 x 60 mm  
 TS.04.64.19 Ø 19 x 70 mm  
 TS.04.64.22 Ø 22 x 90 mm

# Intestinal and Tissue Grasping Forceps

Lateral blades only (Pair)



TS.04.64.74  
Frame only



TS.04.64.50

**ALAN PARKS**  
Comprising 1 Retractor  
bows with fine adjustment ratchets,  
1 adjustable centre blade and  
TS.04.64.50 with 2 Adult size lateral blades.  
TS.04.64.51 with 2 Child size lateral blades.  
TS.04.64.52 with 2 Sphincterotomy size lateral blades.  
TS.04.64.53 with 2 Anastomosis size lateral blades.

Adult size	
Child size	
Sphincterotomy size	
Anastomosis size	
Centre Blade	
Illuminated Centre Blade	

# Intestinal and Tissue Grasping Forceps



NAUNTON MORGAN  
TS.04.64.70  
Large, 64 mm long x 24 mm diameter

TS.04.64.71  
Medium, 64 mm long x 20.5 mm diameter

TS.04.64.72  
Small, 64 mm long x 17 mm diameter

TS.04.64.73  
Illumination stem for metal proctoscope.

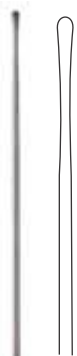

malleable

PRATT  
TS.04.68.20  
28 cm/ 11"  
nickel silver

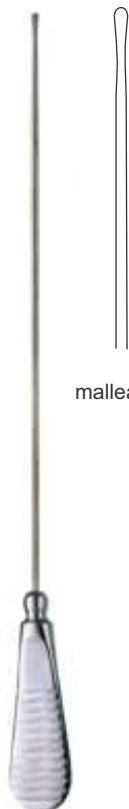

malleable

BUIE  
TS.04.69.16  
21.5 cm/ 8½"  
nickel silver



BRODIE  
TS.04.70.18  
18 cm/ 7⅞"



LOCKHART MUMMERY  
16 cm/ 6¼"



TS.04.70.21  
# 1



TS.04.70.22  
# 2

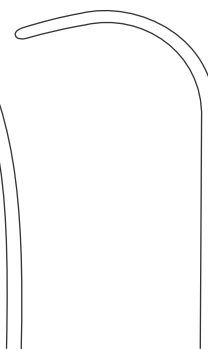

TS.04.70.23  
# 3

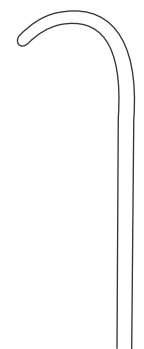

TS.04.70.24  
# 4

# Intestinal and Tissue Grasping Forceps

max. spread 115 mm

TS.04.70.52 X 72 mm  
Lateral blades only (Pair)



TS.04.70.54  
Frame only

PARK  
TS.04.70.50  
1X TS.04.70.54  
1X TS.04.70.55

23 X 70 mm  
Blades

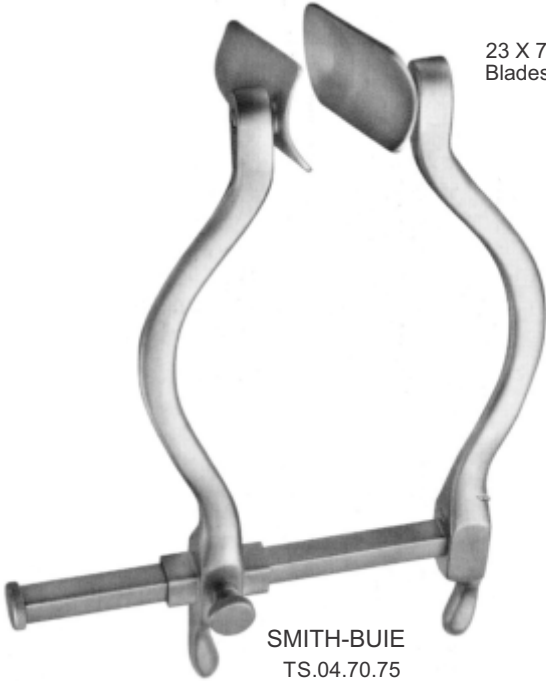

SMITH-BUIE  
TS.04.70.75

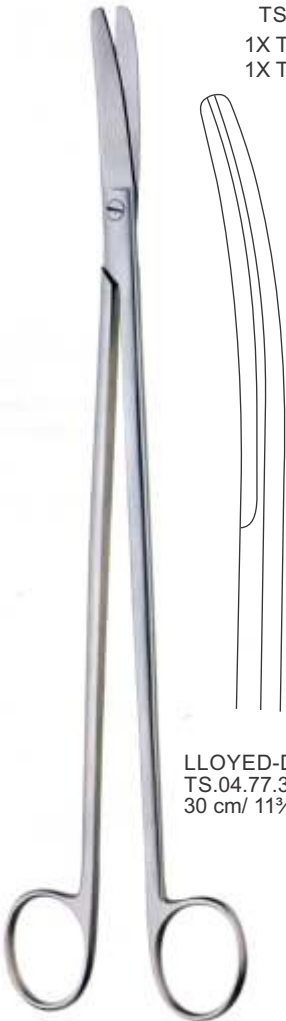

LLOYED-DAVIS  
TS.04.77.31  
30 cm / 11 3/4"

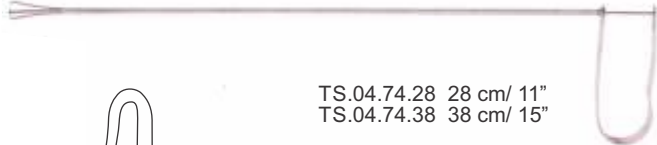

TS.04.74.28 28 cm / 11"  
TS.04.74.38 38 cm / 15"



TS.04.78.21

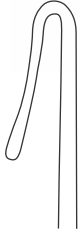

TS.04.78.22



TS.04.78.23

PRATT  
21 cm / 8 1/4"

# Intestinal and Tissue Grasping Forceps

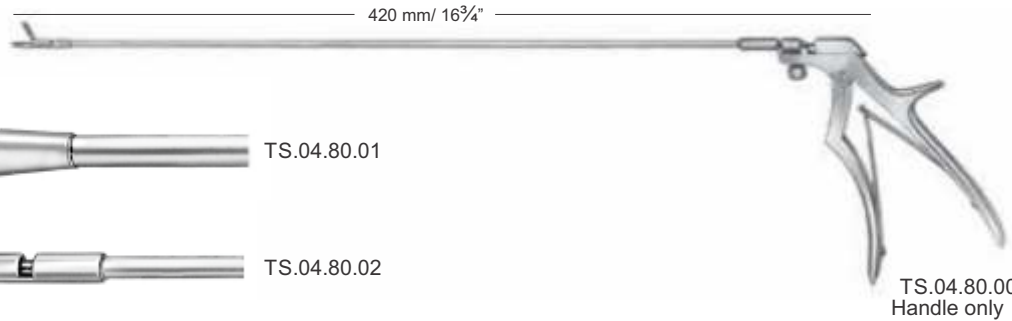

TS.04.80.01



TS.04.80.02



TS.04.80.03



TS.04.80.04



TS.04.80.05



MCGIVNEY  
 TS.04.81.19  
 19 cm / 7 1/2"



HEYWOOD-SMITH  
 TS.04.82.21  
 21 cm / 8 1/4"

# Intestinal and Tissue Grasping Forceps

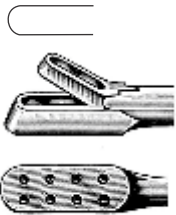
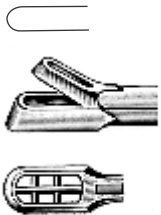
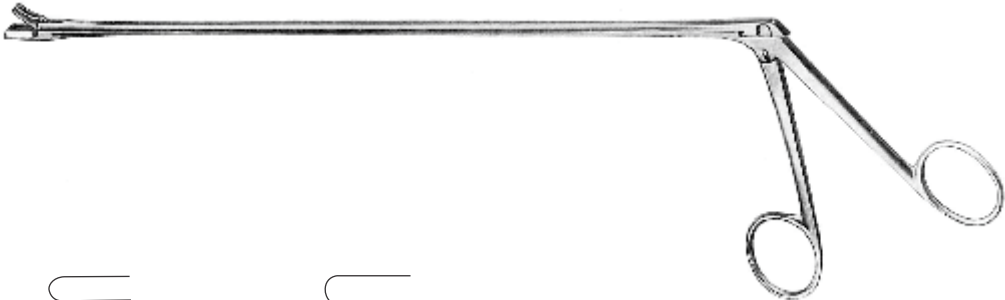
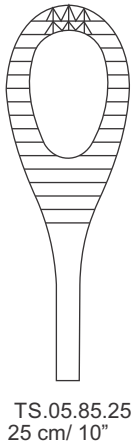
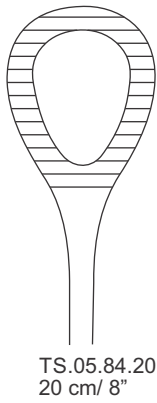
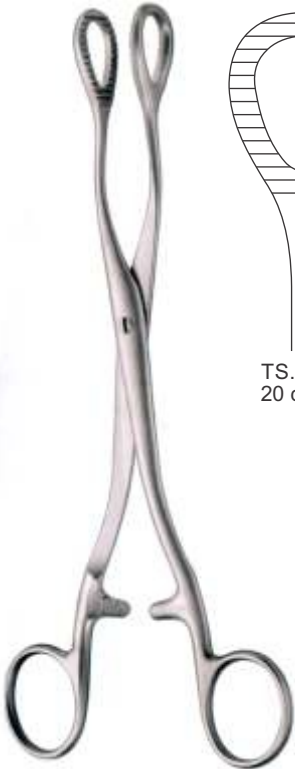

Shaft length	TS.05.86.18	TS.05.86.28
28 cm / 11"	TS.05.86.25	TS.05.86.35
35 cm / 13¾"	TS.05.86.33	TS.05.86.43
43 cm / 17"		

# Intestinal and Tissue Grasping Forceps





# Intestinal and Tissue Grasping Forceps



HOESEL  
TS.05.89.50  
25 cm/ 10"

# Intestinal and Tissue Grasping Forceps

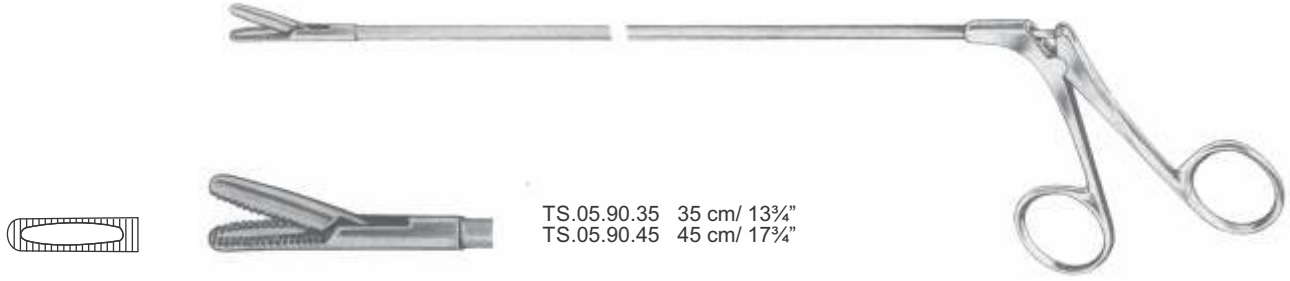

INSULATED BIOPSY FORCEPS  
for Rectal HF-Surgery

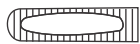

TS.05.90.35 35 cm / 13<sup>3</sup>/<sub>4</sub>"  
TS.05.90.45 45 cm / 17<sup>3</sup>/<sub>4</sub>"



TS.05.91.35 35 cm / 13<sup>3</sup>/<sub>4</sub>"  
TS.05.91.45 45 cm / 17<sup>3</sup>/<sub>4</sub>"



TS.05.92.35 35 cm / 13<sup>3</sup>/<sub>4</sub>"  
TS.05.92.45 45 cm / 17<sup>3</sup>/<sub>4</sub>"



TS.05.93.35 35 cm / 13<sup>3</sup>/<sub>4</sub>"  
TS.05.93.45 45 cm / 17<sup>3</sup>/<sub>4</sub>"



TS.05.94.35 35 cm / 13<sup>3</sup>/<sub>4</sub>"  
TS.05.94.45 45 cm / 17<sup>3</sup>/<sub>4</sub>"

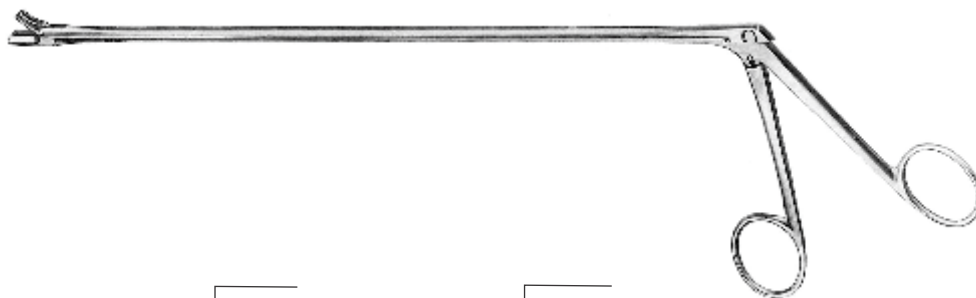

YEOMAN



Shaft length		
28 cm / 11"	TS.05.95.18	TS.05.95.28
35 cm / 13 <sup>3</sup> / <sub>4</sub> "	TS.05.95.25	TS.05.95.35
43 cm / 17"	TS.05.95.33	TS.05.95.43

# Intestinal and Tissue Grasping Forceps



TS.05.95.63 35 cm/ 13<sup>3</sup>/<sub>4</sub>"  
TS.05.95.64 45 cm/ 17<sup>3</sup>/<sub>4</sub>"



TS.05.95.51

TS.05.95.52

JACKSON  
35 cm/ 13<sup>3</sup>/<sub>4</sub>"



Combined Suction  
HAEMORRHOIDAL LIGATOR  
TS.05.98.48  
33 cm/ 13"



Gynecology

# Gynecology

105 x 38 mm



105 x 27 mm



88 x 25 mm



AUVARD  
TS.05.02.24  
24 cm/ 9½"

SIMON  
28 cm/ 11"

TS.05.03.28  
115 x 22 mm

TS.05.03.29  
115 x 27 mm

MARTIN  
TS.05.03.25  
25 cm/ 10"

LONDON  
TS.05.03.22  
22 cm/ 8¾"

# Gynecology



**DOYEN**  
 25 cm/ 10"

- TS.05.04.01 55 x 45 mm
- TS.05.04.02 85 x 45 mm
- TS.05.04.03 115 x 45 mm

60 x 30 mm



**DOYEN**  
 TS.05.06.23  
 23 cm/ 9"



**MATZENAUER**  
 20-23 cm/ 8"-9"

- TS.05.06.50 90 x 20 mm
- TS.05.06.51 100 x 10 mm
- TS.05.06.52 100 x 15 mm
- TS.05.06.53 100 x 20 mm
- TS.05.06.54 100 x 25 mm
- TS.05.06.55 110 x 25 mm
- TS.05.06.56 110 x 30 mm
- TS.05.06.57 120 x 10 mm
- TS.05.06.58 120 x 15 mm
- TS.05.06.59 120 x 20 mm
- TS.05.06.60 120 x 25 mm
- TS.05.06.61 120 x 30 mm
- TS.05.06.62 120 x 35 mm
- TS.05.06.63 130 x 20 mm
- TS.05.06.64 130 x 25 mm
- TS.05.06.65 130 x 30 mm
- TS.05.06.66 130 x 35 mm
- TS.05.06.67 130 x 40 mm

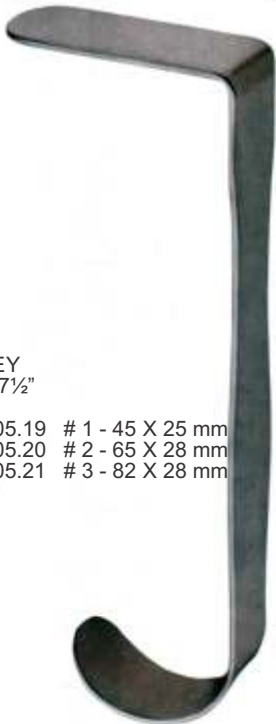

**HEANEY**  
 19 cm/ 7½"

- TS.05.05.19 # 1 - 45 X 25 mm
- TS.05.05.20 # 2 - 65 X 28 mm
- TS.05.05.21 # 3 - 82 X 28 mm

80 x 30 mm



**DOYEN**  
 TS.05.06.25  
 25 cm/ 10"

# Gynecology

\* for virgins

Vienna pattern

Vienna pattern

(Ret. & Spec.)

Complete Set  
TS.05.09.01  
TS.05.09.05

**KRISTELLER**  
23 cm/ 9"

- \*TS.05.07.18 # 0 - 110 x 20 mm
- TS.05.07.24 # 1 - 110 x 27 mm
- TS.05.07.45 # 2 - 110 x 30 mm
- TS.05.07.56 # 3 - 110 x 36 mm

**KRISTELLER**  
23 cm/ 9"

- \*TS.05.07.19 # 0 - 115 x 17 mm
- TS.05.07.25 # 1 - 115 x 23 mm
- TS.05.07.46 # 2 - 115 x 26 mm
- TS.05.07.57 # 3 - 115 x 32 mm

**MATHIEU**  
20 cm/ 8"

- \*TS.05.09.10 # 1 - 95 x 16 - 26 mm
- TS.05.09.15 # 2 - 95 x 16 - 30 mm



**MATHIEU**  
20 cm/ 8"

- \* TS.05.09.25 # 1 - 100 x 11 - 20 mm
- TS.05.09.35 # 2 - 100 x 14 - 26 mm

\* for virgins



**KRISTELLER**  
22 cm/ 8<sup>3</sup>/<sub>4</sub>"

- \* TS.05.10.20 # 0 - 110 x 20 mm
- TS.05.10.27 # 1 - 110 x 27 mm
- TS.05.10.30 # 2 - 110 x 30 mm
- TS.05.10.36 # 3 - 110 x 36 mm

**KRISTELLER**  
22 cm/ 8<sup>3</sup>/<sub>4</sub>"

- \*TS.05.12.17 # 0 - 115 x 17 mm
- TS.05.12.23 # 1 - 115 x 23 mm
- TS.05.12.26 # 2 - 115 x 26 mm
- TS.05.12.32 # 3 - 115 x 32 mm





**KRISTELLER**  
 22 cm/ 8¾"

- TS.05.11.20 # 0 - 110 x 20 mm
- TS.05.11.27 # 1 - 110 x 27 mm
- TS.05.11.30 # 2 - 110 x 30 mm
- TS.05.11.36 # 3 - 110 x 36 mm



**EASTMAN**  
 17 cm/ 6¾"

- TS.05.13.10 75 x 38 mm
- TS.05.13.20 90 x 38 mm
- TS.05.13.33 100 x 38 mm



**JACKSON**  
 17 cm/ 6¾"

- TS.05.14.10 75 x 38 mm
- TS.05.14.20 90 x 38 mm
- TS.05.14.30 100 x 38 mm

\* for virgins



**KRISTELLER**  
 18 cm/ 7⅙"

- \* TS.05.15.15 # 0 - 70 x 15 mm
- TS.05.15.27 # 1 - 70 x 27 mm
- TS.05.15.30 # 2 - 75 x 30 mm
- TS.05.15.36 # 3 - 90 x 36 mm

**KRISTELLER**  
 18 cm/ 7⅙"

- \* TS.05.16.10 # 0 - 75 x 10 mm
- TS.05.16.23 # 1 - 75 x 23 mm
- TS.05.16.25 # 2 - 80 x 25 mm
- TS.05.16.32 # 3 - 100 x 32 mm



# Gynecology

\* for virgins

**KRISTELLER**  
\* TS.05.17.0# 0 - 70 X 15 mm  
TS.05.17.1# 1 - 70 X 27 mm  
TS.05.17.2# 2 - 75 X 30 mm  
TS.05.17.3# 3 - 90 X 6 mm  
18 cm/ 7 $\frac{1}{8}$ "



set complete

for children

**KRISTELLER**  
TS.05.18.18  
21.5 cm/ 8 $\frac{1}{2}$ "  
110 x 18 mm



**KRISTELLER**  
TS.05.18.20  
21.5 cm/ 8 $\frac{1}{2}$ "  
110 x 18 mm



**KRISTELLER**  
TS.05.18.25  
21.5 cm/ 8 $\frac{1}{2}$ "  
115 x 14 mm



**BREISKY**  
TS.05.19.10  
# 1 - 70 x 22 mm  
76 x 25 mm  
12.5 cm/ 5"

**TS.05.19.20**  
# 2 - 76 x 25 mm  
82 x 30 mm  
14.5 cm/ 5 $\frac{3}{4}$ "

**TS.05.19.30**  
# 3 - 82 x 30 mm  
95 x 38 mm  
16.5 cm/ 6 $\frac{1}{2}$ "



Set of 3 Pieces

SIMS  
 TS.05.20.03  
 18 cm/ 7 1/8"

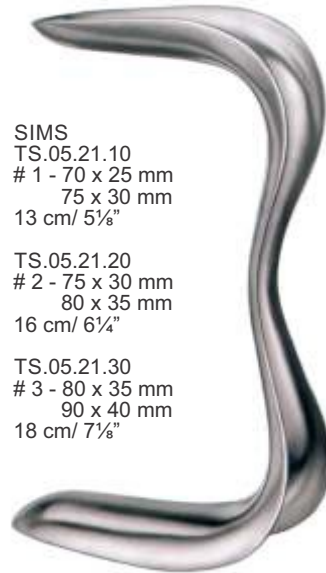

SIMS  
 TS.05.21.10  
 # 1 - 70 x 25 mm  
 75 x 30 mm  
 13 cm/ 5 1/8"

TS.05.21.20  
 # 2 - 75 x 30 mm  
 80 x 35 mm  
 16 cm/ 6 1/4"

TS.05.21.30  
 # 3 - 80 x 35 mm  
 90 x 40 mm  
 18 cm/ 7 1/8"



KALLMORGEN  
 TS.05.22.07  
 # 1 - 70 x 33 mm  
 18.5 cm/ 7 1/4"

TS.05.22.09  
 # 2 - 90 x 33 mm  
 21.5 cm/ 8 1/2"



KALLMORGEN  
 TS.05.22.40  
 # 1 - 70 x 40 mm  
 18.5 cm/ 7 1/4"

TS.05.22.55  
 # 2 - 90 x 40 mm  
 21.5 cm/ 8 1/2"



set complete

KALLMORGEN  
 TS.05.22.70  
 # 1 - 70 x 40 mm  
 18.5 cm/ 7 1/4"

TS.05.22.90  
 # 2 - 90 x 40 mm  
 21.5 cm/ 8 1/2"

# Gynecology

TS.05.23.01 - Small  
TS.05.23.02 - Medium  
TS.05.23.03 - Large



**COLLIN**  
TS.05.23.25 90 x 25 mm  
TS.05.23.27 90 x 27 mm  
TS.05.23.29 90 x 29 mm  
TS.05.23.32 90 x 32 mm  
TS.05.23.33 100 x 32 mm  
TS.05.23.34 110 x 34 mm  
TS.05.23.35 100 x 35 mm  
TS.05.23.36 110 x 36 mm  
TS.05.23.38 100 x 38 mm  
TS.05.23.40 100 x 40 mm  
TS.05.23.41 110 x 40 mm



**COLLIN**  
TS.05.24.16 90 X 16 mm  
TS.05.24.20 65 X 20 mm

for virgins



**COLLIN-LANDAU**  
TS.05.25.30 90 x 30 mm  
TS.05.25.35 100 x 35 mm  
TS.05.25.37 110 x 40 mm

for children



**COLLIN**  
TS.05.26.00  
55 x 10 mm



**GRAVES MODIF.**  
TS.05.27.45  
115 x 35 mm  
45°



**GRAVES MODIF.**  
TS.05.27.90  
115 x 35 mm  
90°



**SEMM**  
 TS.05.28.18 90 x 14 mm - 18 mm  
 TS.05.28.20 100 x 17 mm - 20 mm  
 TS.05.28.30 110 x 25 mm - 30 mm



**PEDIERSON**  
 TS.05.29.13 76 x 13 mm  
 TS.05.29.22 100 x 22 mm  
 TS.05.29.25 120 x 25 mm



**GRAVES**  
 TS.05.30.20 75 x 20 mm  
 TS.05.30.30 100 x 30 mm  
 TS.05.30.35 115 x 35 mm



**SEYFFERT**  
 TS.05.31.17 100 x 17 mm  
 TS.05.31.33 110 x 33 mm



**CUSCO**  
 TS.05.32.17  
 75 x 17 mm  
 for virgins



**CUSCO**  
 TS.05.32.32 75 x 32 mm  
 TS.05.32.36 85 x 36 mm  
 TS.05.32.37 95 x 37 mm  
 TS.05.32.38 100 x 37 mm

# Gynecology



CUSCO  
TS.05.32.62 15 x 95 mm  
TS.05.32.63 25 x 100 mm  
TS.05.32.65 30 x 120 mm  
TS.05.32.66 35 x 105 mm



Swiss pattern

CUSCO  
TS.05.33.25 90 x 23 mm - 25 mm  
TS.05.33.27 100 x 25 mm - 27 mm  
TS.05.33.30 110 x 27 mm - 30 mm



TRELAT  
TS.05.34.01 85 x 33 mm  
TS.05.34.02 95 x 35 mm  
TS.05.34.03 115 x 43 mm



CUSCO  
TS.05.34.32 75 x 32 mm  
TS.05.34.36 85 x 36 mm  
TS.05.34.37 95 x 37 mm  
TS.05.34.38 100 x 35 mm

for virgins



CUSCO  
TS.05.34.75  
75 x 17 mm



NOTT  
TS.05.34.81 90 x 30 mm  
TS.05.34.82 110 x 30 mm



BOZEMANN  
TS.05.37.38 80 x 30 mm  
TS.05.37.42 85 x 33 mm  
TS.05.37.45 100 x 35 mm  
TS.05.37.50 110 x 42 mm



BOZEMANN  
TS.05.37.55 70 x 30 mm  
TS.05.37.56 85 x 35 mm  
TS.05.37.57 90 x 35 mm  
TS.05.37.58 110 x 42 mm



BOZEMANN  
TS.05.36.01  
23 cm/ 9"  
MOD. A



BOZEMANN  
TS.05.36.02  
24 cm/ 9½"  
MOD. B

BOZEMANN  
TS.05.36.00

Vaginal speculum, set complete, consisting of:  
1 Handle mod. A No.TS.05.36.01  
1 Handle mod. B No.TS.05.36.02  
8 Speculum blades No.TS.05. 37.38 - TS.05.37.58

# Gynecology



## BREISKY

28-31 cm - 11"-12 $\frac{1}{8}$ "

TS.05.35.01	70 x 25 mm	TS.05.35.02	100 x 20 mm
TS.05.35.03	80 x 25 mm	TS.05.35.04	100 x 25 mm
TS.05.35.05	90 x 25 mm	TS.05.35.06	100 x 30 mm
TS.05.35.07	100 x 10 mm	TS.05.35.08	100 x 35 mm
TS.05.35.09	100 x 15 mm	TS.05.35.10	100 x 40 mm

TS.05.35.11	110 x 20 mm	TS.05.35.21	120 x 20 mm
TS.05.35.12	110 x 25 mm	TS.05.35.22	120 x 25 mm
TS.05.35.13	110 x 30 mm	TS.05.35.23	120 x 30 mm
TS.05.35.19	120 x 10 mm	TS.05.35.24	120 x 35 mm
TS.05.35.20	120 x 15 mm	TS.05.35.25	120 x 40 mm

Vienna pattern



## BREISKY

32-42 cm - 12 $\frac{1}{2}$ "-16 $\frac{1}{2}$ "

TS.05.36.31	130 x 20 mm	TS.05.36.55	155 x 40 mm
TS.05.36.32	130 x 25 mm	TS.05.36.63	160 x 30 mm
TS.05.36.33	130 x 30 mm	TS.05.36.66	160 x 45 mm
TS.05.36.34	130 x 35 mm	TS.05.36.73	170 x 30 mm
TS.05.36.35	130 x 40 mm	TS.05.36.74	170 x 35 mm

TS.05.36.44	140 x 35 mm	TS.05.36.85	180 x 40 mm
TS.05.36.45	140 x 40 mm	TS.05.36.91	200 x 25 mm
TS.05.36.46	140 x 45 mm	TS.05.36.92	220 x 25 mm
TS.05.36.52	150 x 25 mm	TS.05.36.94	220 x 35 mm
TS.05.36.53	150 x 30 mm	TS.05.36.95	220 x 40 mm
TS.05.36.54	150 x 35 mm	TS.05.36.96	240 x 20 mm

Vienna pattern



## LANDAU

29 cm/ 11 $\frac{1}{2}$ "

TS.05.36.97	100 x 28 mm
TS.05.36.98	110 x 38 mm

- TS.05.38.01 1 mm
- TS.05.38.02 2 mm
- TS.05.38.03 3 mm
- TS.05.38.04 4 mm
- TS.05.38.05 5 mm
- TS.05.38.06 6 mm
- TS.05.38.07 7 mm
- TS.05.38.08 8 mm
- TS.05.38.09 9 mm
- TS.05.38.10 10 mm
- TS.05.38.11 11 mm
- TS.05.38.12 12 mm
- TS.05.38.13 13 mm
- TS.05.38.14 14 mm
- TS.05.38.15 15 mm
- TS.05.38.16 16 mm
- TS.05.38.17 17 mm
- TS.05.38.18 18 mm
- TS.05.38.19 19 mm
- TS.05.38.20 20 mm
- TS.05.38.21 21 mm
- TS.05.38.22 22 mm
- TS.05.38.23 23 mm
- TS.05.38.24 24 mm
- TS.05.38.25 25 mm
- TS.05.38.26 26 mm



HEGAR



**TS.05.38.44**  
Set of 14 HEGAR uterine dilators, 4 - 17 mm, in metal case.

**TS.05.38.45**  
Set of 26 HEGAR uterine dilators, 1 - 26 mm, in metal case.

- TS.05.39.01 1.5 mm
- TS.05.39.02 2.5 mm
- TS.05.39.03 3.5 mm
- TS.05.39.04 4.5 mm
- TS.05.39.05 5.5 mm
- TS.05.39.06 6.5 mm
- TS.05.39.07 7.5 mm
- TS.05.39.08 8.5 mm
- TS.05.39.09 9.5 mm
- TS.05.39.10 10.5 mm
- TS.05.39.11 11.5 mm
- TS.05.39.12 12.5 mm
- TS.05.39.13 13.5 mm
- TS.05.39.14 14.5 mm
- TS.05.39.15 15.5 mm
- TS.05.39.16 16.5 mm
- TS.05.39.17 17.5 mm
- TS.05.39.18 18.5 mm
- TS.05.39.19 19.5 mm
- TS.05.39.20 20.5 mm
- TS.05.39.21 21.5 mm
- TS.05.39.22 22.5 mm



**TS.05.38.40**  
Set of 14 HEGAR uterine dilators, 4 - 17 mm, in cardboard box

**TS.05.38.41**  
Set of 26 HEGAR uterine dilators, 1 - 26 mm, in cardboard box



**TS.05.38.42**  
Set of 14 HEGAR uterine dilators, 4 - 17 mm, in black pouch.

- TS.05.40.01 1 + 2 mm
- TS.05.40.03 3 + 4 mm
- TS.05.40.05 5 + 6 mm
- TS.05.40.07 7 + 8 mm
- TS.05.40.09 9 + 10 mm
- TS.05.40.11 11 + 12 mm
- TS.05.40.13 13 + 14 mm
- TS.05.40.15 15 + 16 mm
- TS.05.40.17 17 + 18 mm
- TS.05.40.19 19 + 20 mm
- TS.05.40.21 21 + 22 mm
- TS.05.40.23 23 + 24 mm
- TS.05.40.25 25 + 26 mm



HEGAR

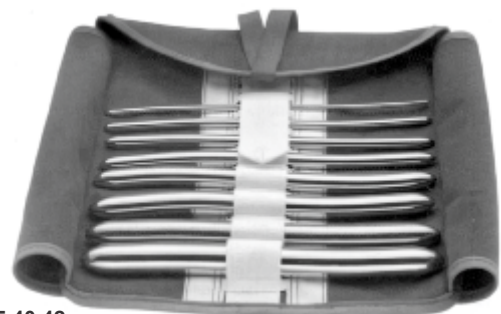

**TS.05.40.42**  
Set of 8 HEGAR uterine dilators, 3 + 4 mm - 17 + 18 in carrying case.



# Gynecology



HANK

- TS.05.40.50 # 9/10 (4½ + 5 mm)
- TS.05.40.52 # 11/12 (5½ + 6 mm)
- TS.05.40.54 # 13/14 (6½ + 7 mm)
- TS.05.40.56 # 15/16 (7½ + 8 mm)
- TS.05.40.58 # 17/18 (8½ + 9 mm)
- TS.05.40.60 # 19/20 (9½ + 10 mm)

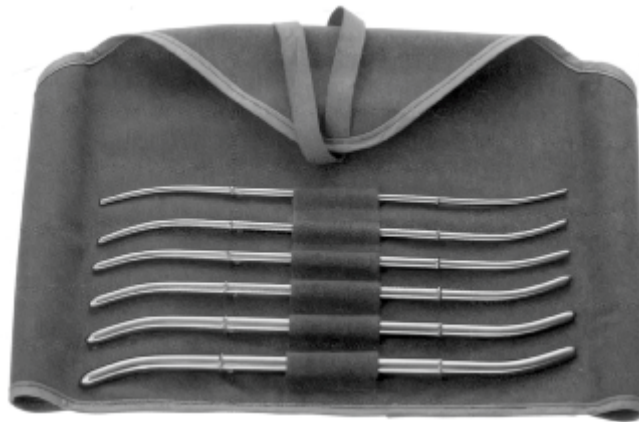

**TS.05.40.70**  
Set of 6 HANK uterine dilators,  
# 9/10-19/20, in canvas roll.



PARTT

- TS.05.40.73 # 13/15 ( 4½ + 5 mm)
- TS.05.40.75 # 17/19 ( 5⅔ + 1⅙mm)
- TS.05.40.77 # 21/23 ( 7 + ⅔mm)
- TS.05.40.79 # 25/27 ( 8⅓ + 9 mm)
- TS.05.40.81 # 29/31 ( 9⅔ + 10⅓ mm)
- TS.05.40.83 # 33/35 (11 + ⅔mm)
- TS.05.40.85 # 37/39 (12⅓ + 13 mm)
- TS.05.40.87 # 41/43 (13⅓ + 14⅓ mm)

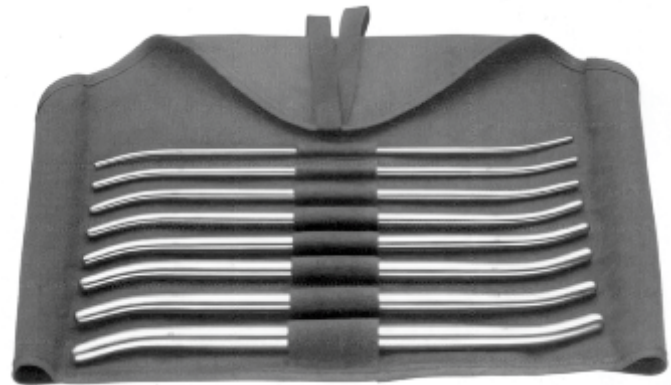

**TS.05.40.92**  
Set of 8 PRATT uterine dilators,  
# 13/15 - 41/43, in canvas roll.

# Gynecology



HEGAR  
 with serrated handle

- TS.05.42.01 1 mm
- TS.05.42.02 2 mm
- TS.05.42.03 3 mm
- TS.05.42.04 4 mm
- TS.05.42.05 5 mm
- TS.05.42.06 6 mm
- TS.05.42.07 7 mm
- TS.05.42.08 8 mm
- TS.05.42.09 9 mm
- TS.05.42.10 10 mm
- TS.05.42.11 11 mm
- TS.05.42.12 12 mm
- TS.05.42.13 13 mm
- TS.05.42.14 14 mm
- TS.05.42.15 15 mm
- TS.05.42.16 16 mm
- TS.05.42.17 17 mm
- TS.05.42.18 18 mm
- TS.05.42.19 19 mm
- TS.05.42.20 20 mm
- TS.05.42.21 21 mm
- TS.05.42.22 22 mm
- TS.05.42.23 23 mm
- TS.05.42.24 24 mm
- TS.05.42.25 25 mm
- TS.05.42.26 26 mm



30 cm/ 11¾"  
 TS.05.43.30 corrugated ends  
 TS.05.43.33 smooth ends

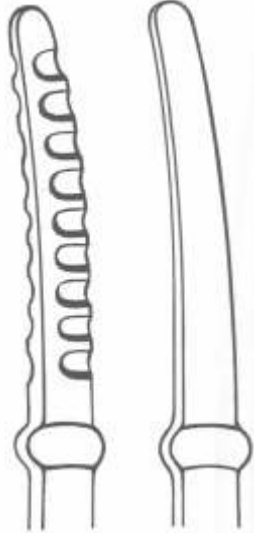

TS.05.43.30 TS.05.43.33  
 TS.05.44.30 TS.05.44.33



WYLIE  
 30 cm/ 11¾"  
 TS.05.44.30 corrugated ends  
 TS.05.44.33 smooth ends

# Gynecology



SCHERBACK  
TS.05.45.61 80 x 30 mm  
TS.05.45.62 85 x 35 mm  
TS.05.45.63 90 x 40 mm



SCHERBACK  
TS.05.45.64 55 x 40 - 60 mm  
TS.05.45.65 70 x 45 - 70 mm



SIMS  
TS.05.45.28  
28 cm / 11"



SCHERBACK  
TS.05.45.75  
19 cm - 7½"



SCHERBACK  
TS.05.45.77 400 g  
TS.05.45.78 600 g

# Gynecology

graduated in inches

graduated in cm

6 x 20 mm

6 x 20 mm



**KOGAN**  
**TS.05.47.24**  
 24 cm/ 9½"

**KOGAN**  
**TS.05.47.40**  
 24 cm/ 9½"  
 with graduated locking spindle

**KOGAN SEIDL**  
**TS.05.47.54**  
 24 cm/ 9½"

**SIMS**  
 32 cm/ 12½"  
**TS.05.49.31** **TS.05.49.32**  
 malleable rigid

**SIMPSON**  
 27 cm/ 10¾"  
**TS.05.50.28**

# Gynecology



VALLEIX  
28 cm/ 11"  
TS.05.51.25  
rigid

EMMET (SIMS)  
TS.05.52.30  
30 cm/ 12"

MARTIN  
30 cm/ 11¾"  
TS.05.53.30 TS.05.53.32  
rigid malleable

SIMPSON  
27 cm/ 10¾"  
TS.05.54.33  
malleable

SIMS  
26.5 cm/ 10½"  
TS.05.56.26  
malleable

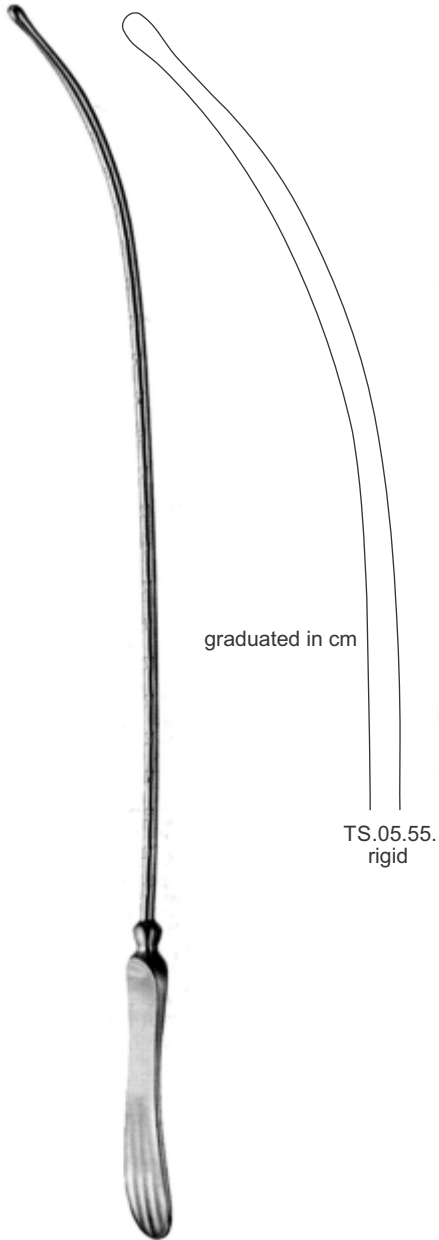

SIMS  
32 cm - 12½"

graduated in cm

TS.05.55.  
rigid



BRAUN

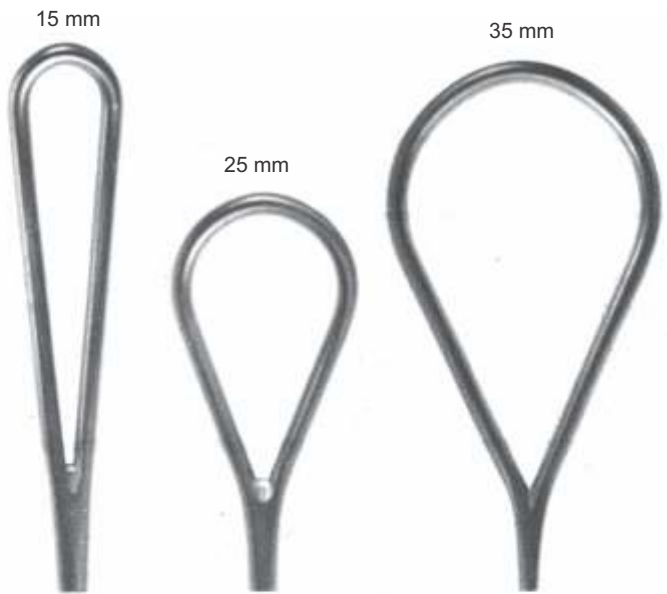

15 mm  
TS.05.57.15  
28.5 cm / 11¼"

25 mm  
TS.05.57.25  
26 cm / 10¼"

35 mm  
TS.05.57.35  
27cm / 10¾"

# Gynecology



**BRAUN**  
**TS.05.58.27**  
27 cm/ 10½"

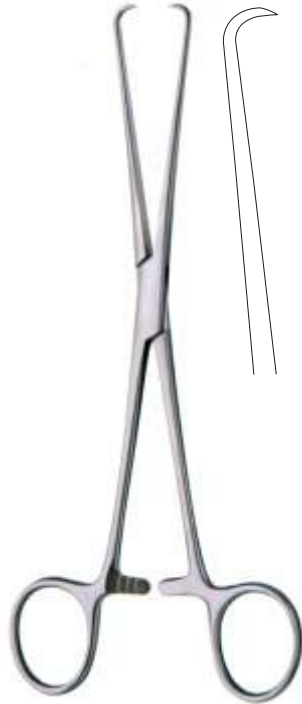

**BARRETT**  
**TS.05.62.18**  
18 cm/ 7¼"

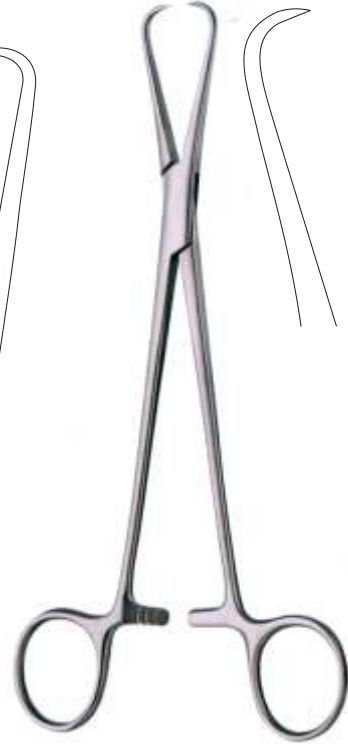

**ADAIR**  
**TS.05.62.19**  
19 cm/ 7½"



**SCHROEDER**  
**TS.05.63.25**  
25 cm/ 10"



**SCHROEDER**  
**TS.05.63.26**  
25 cm/ 10"



POZZI  
TS.05.65.25  
25.5 cm/ 10"



BRAUN  
TS.05.67.25  
25 cm/ 10"



MARTIN  
TS.05.66.26  
26.5 cm/ 10½"



ABEL  
TS.05.68.27  
27 cm/ 10¾"



# Gynecology



**POZZI**  
**TS.05.69.25**  
25 cm/ 10"

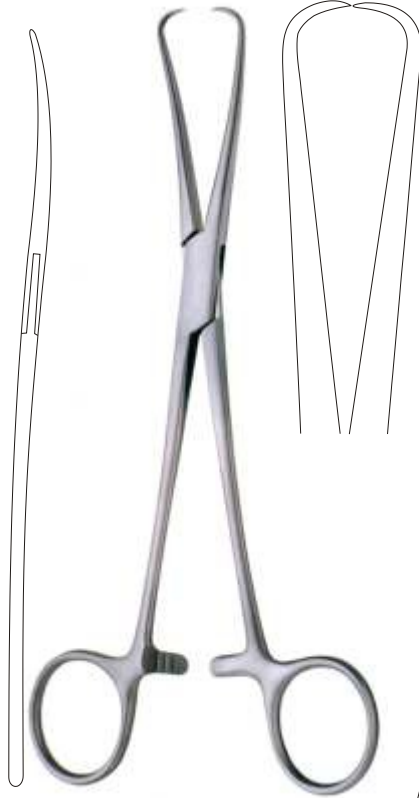

**JARCHO**  
**TS.05.71.20**  
20 cm/ 8"



**POZZI-PALMER**  
**TS.05.70.25**  
25 cm/ 10"



**TS.05.72.25**  
25 cm/ 10"

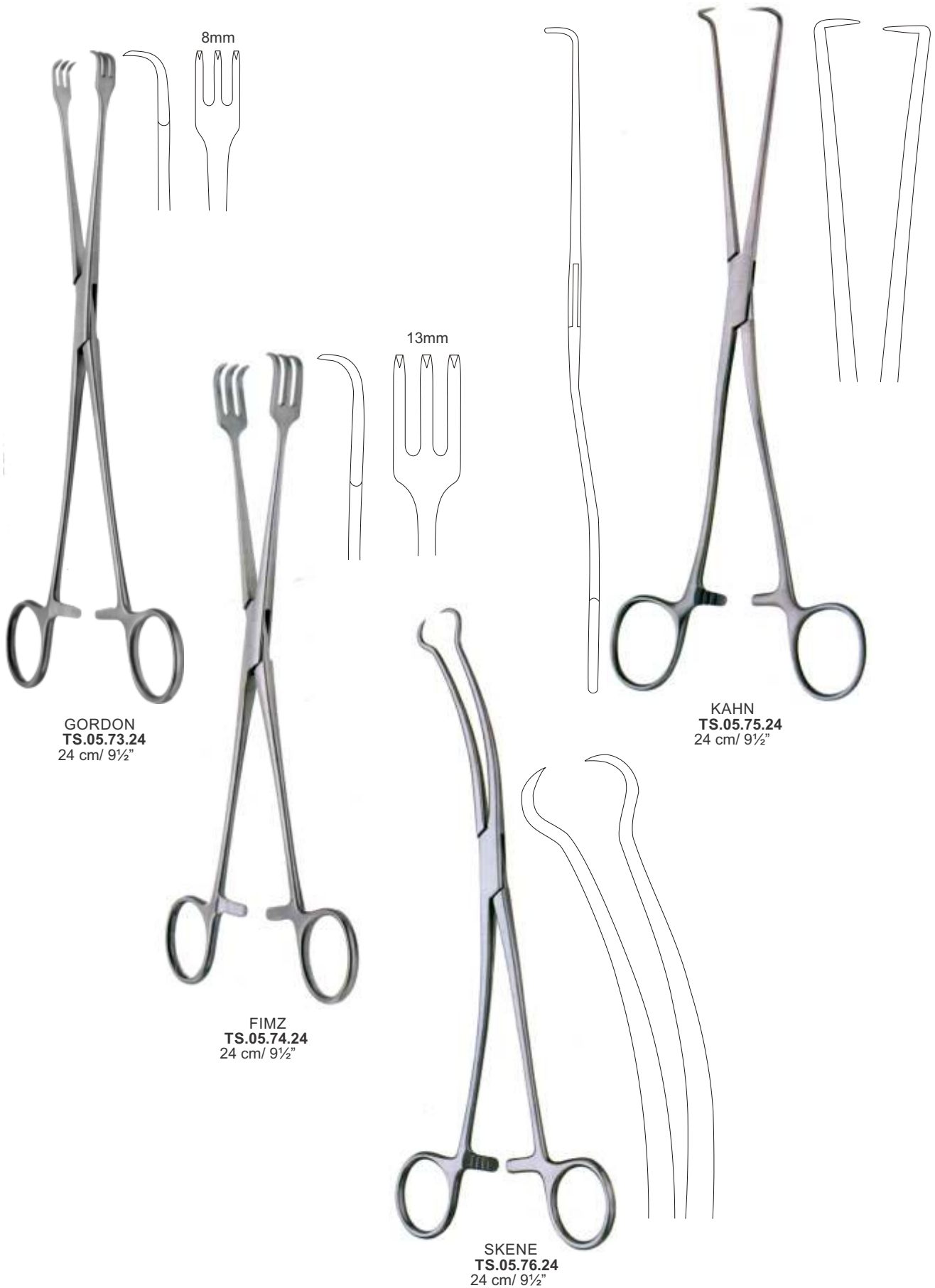

# Gynecology

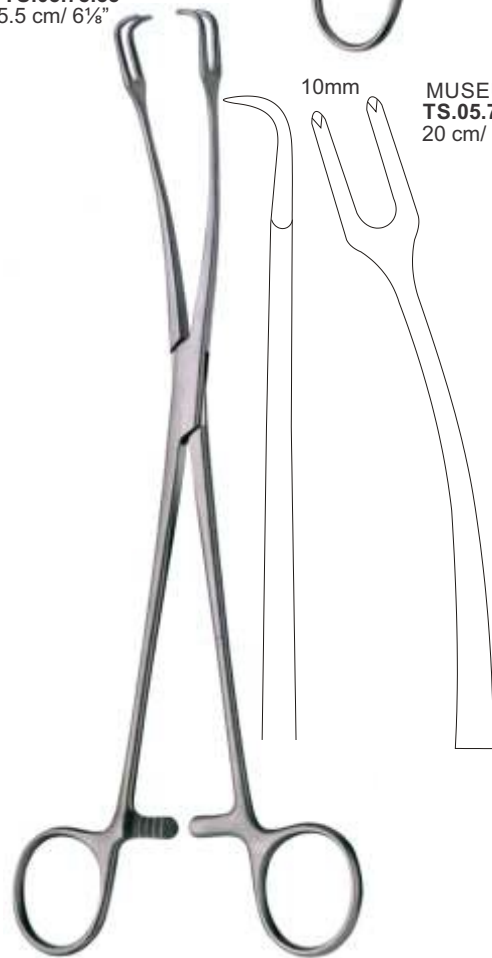
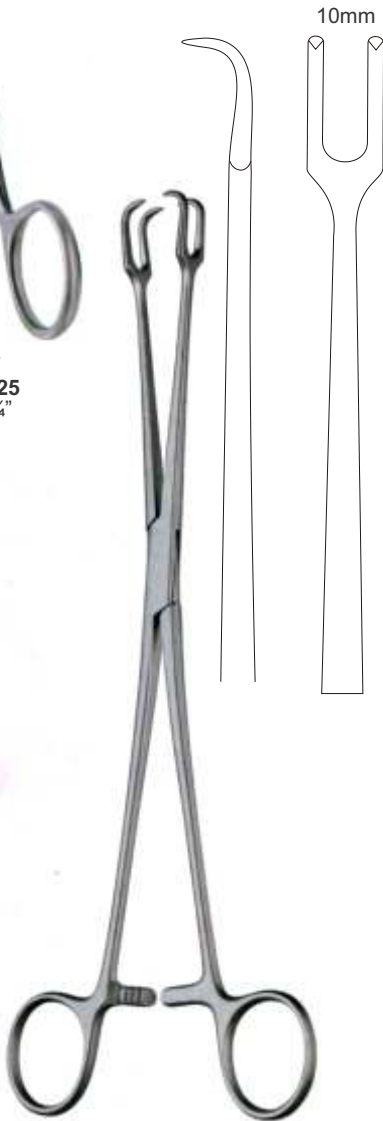

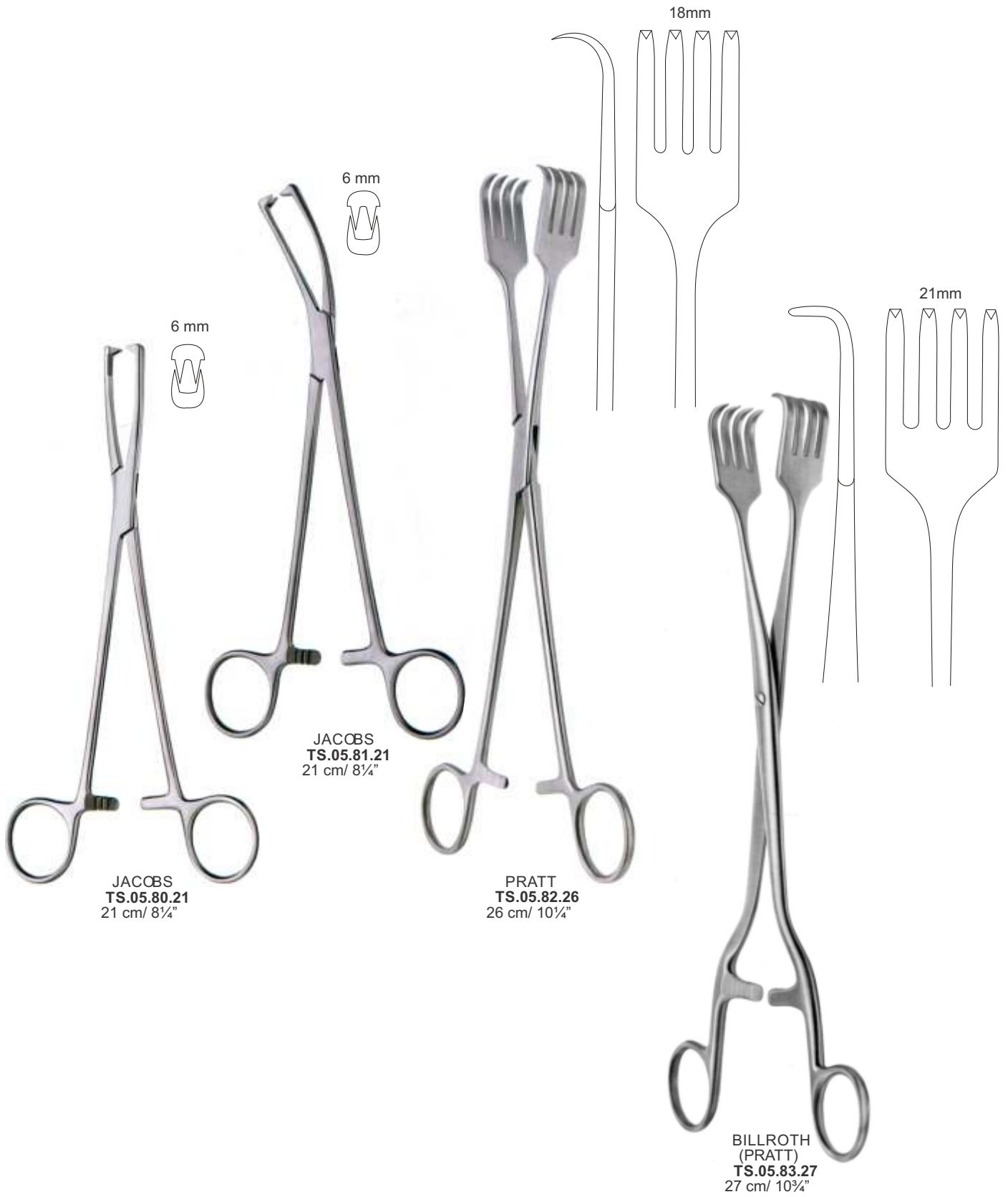



TEALE  
TS.05.98.23  
23 cm/ 9"



TEALE  
TS.05.98.33  
23 cm/ 9"

# Gynecology

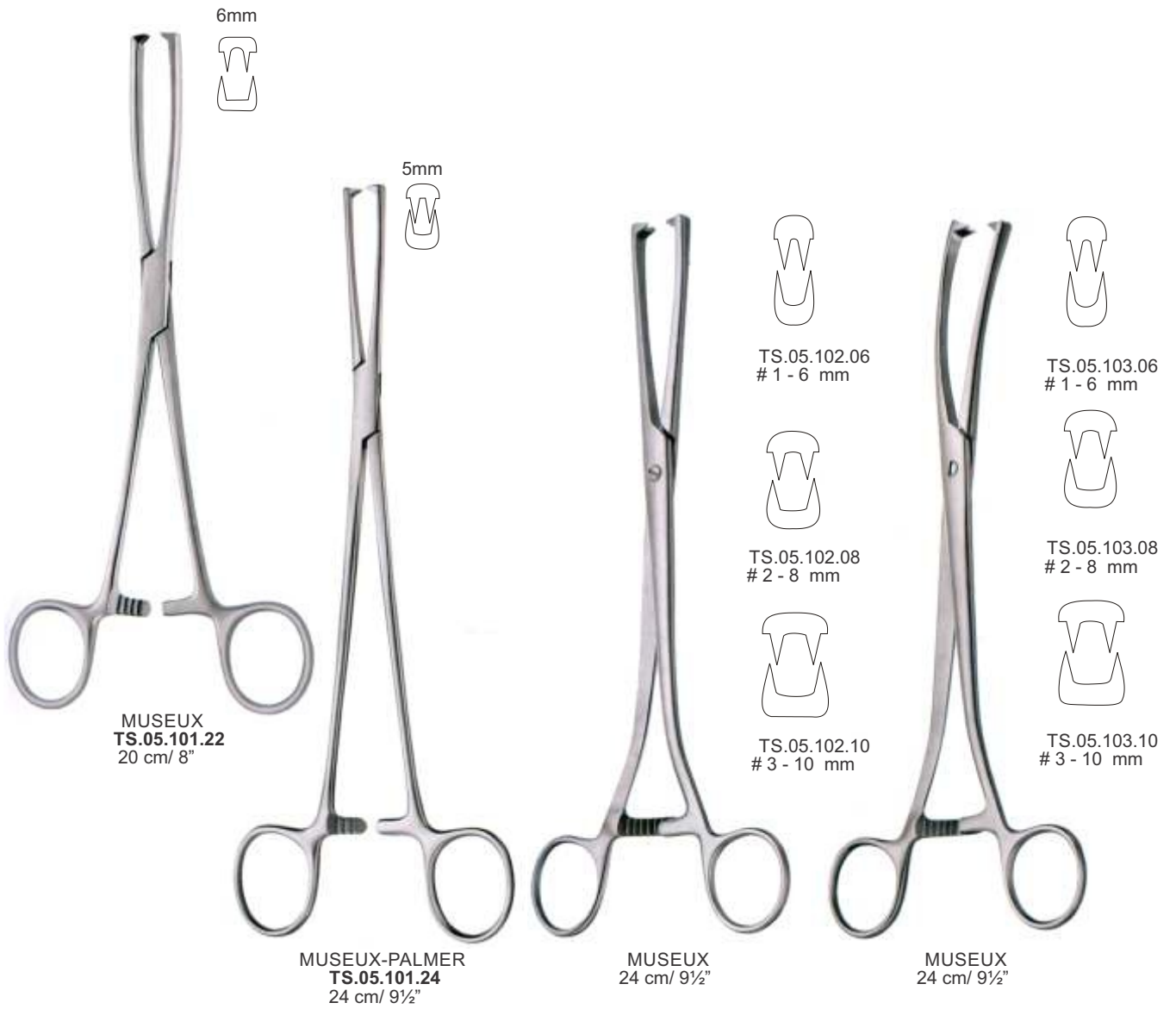

# Gynecology



MUSEUX  
26 cm/ 10¼"



TS.05.104.06  
# 1 - 9 mm



TS.05.104.0  
# 2 - 11 mm

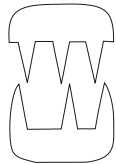

TS.05.104.1  
# 3 - 13 mm



DOYEN  
TS.05.105.20  
20 cm/ 8"

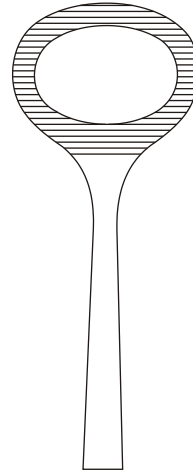

27 mm



NOTO  
TS.05.106.27  
27 cm/ 10¾"

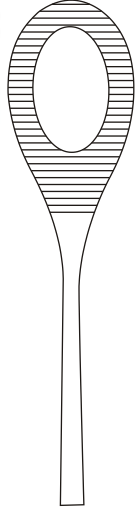

17 mm

18 mm



**KELLY**  
**TS.05.106.32**  
32 cm / 12½"



**COLLIN**  
**TS.05.107.26**  
26 cm / 10¼"



**KELLY**  
**TS.05.108.26**  
26 cm / 10¼"



# Gynecology



TS.05.109.19  
19.5 cm/ 7¾"  
TS.05.109.21  
21 cm/ 8¼"  
TS.05.109.23  
23 cm/ 9"

HEANEY

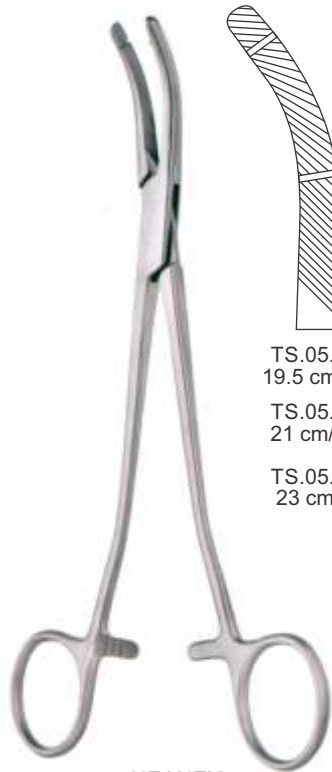

TS.05.110.19  
19.5 cm/ 7¾"  
TS.05.110.21  
21 cm/ 8¼"  
TS.05.110.23  
23 cm/ 9"

HEANEY



HEANEY-REZEK  
TS.05.111.21  
21 cm/ 8¼"

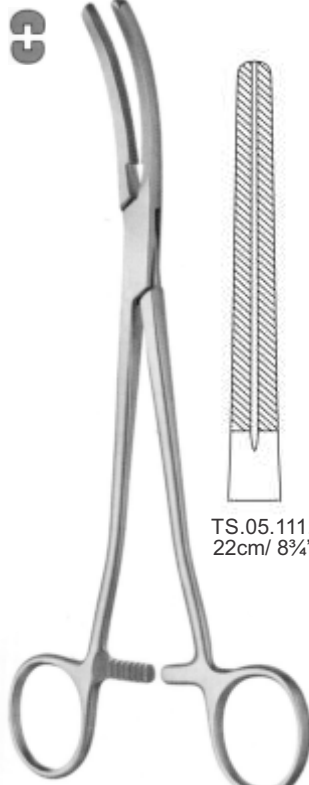

HEANEY "AT"

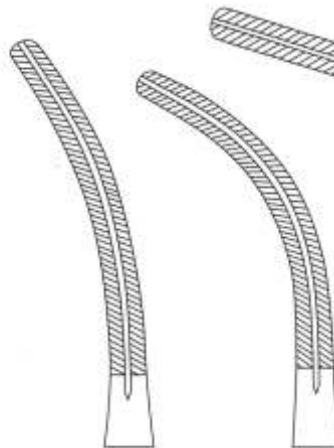

TS.05.111.50  
22cm/ 8¾"

TS.05.111.51  
22cm/ 8¾"

TS.05.111.53  
22cm/ 8¾"

TS.05.111.55  
20cm/ 8"



SOMER  
TS.05.112.24  
24 cm/ 9½"



DARTIGUES  
TS.05.113.26  
27 cm/ 10¾"



COLLIN  
TS.05.113.38  
28 cm/ 11"

# Gynecology

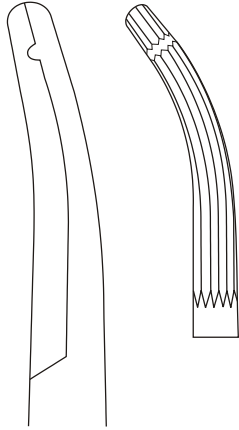

TS.05.115.21

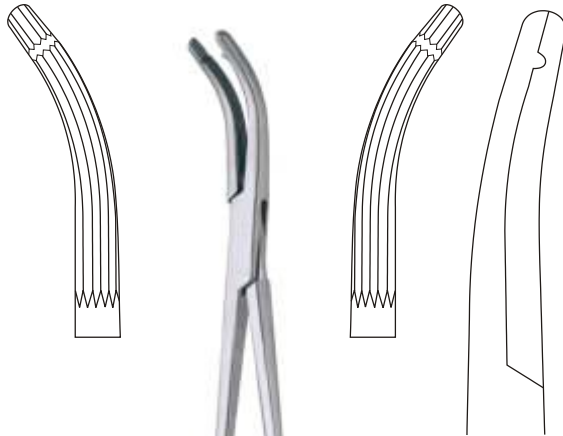

TS.05.114.21

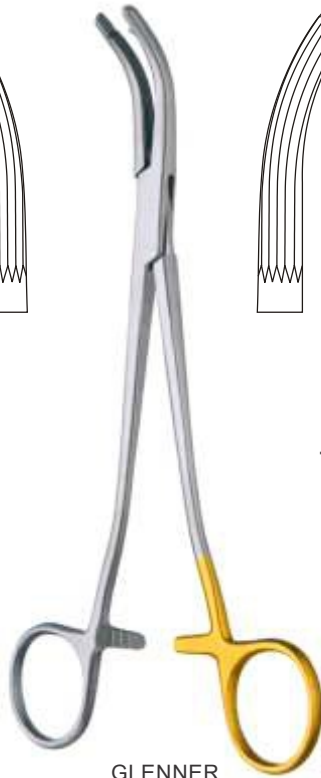

GLENNER  
21 cm/ 8¼"

TS.05.114.20  
Set (TS.05.114.21+  
TS.05.115.21)



MAINGOT  
TS.05.116.20  
20 cm/ 8"

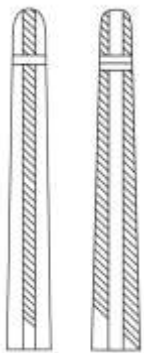

TS.05.116.30

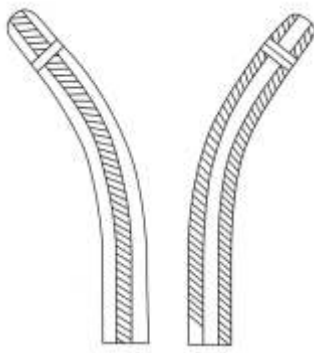

TS.05.116.31

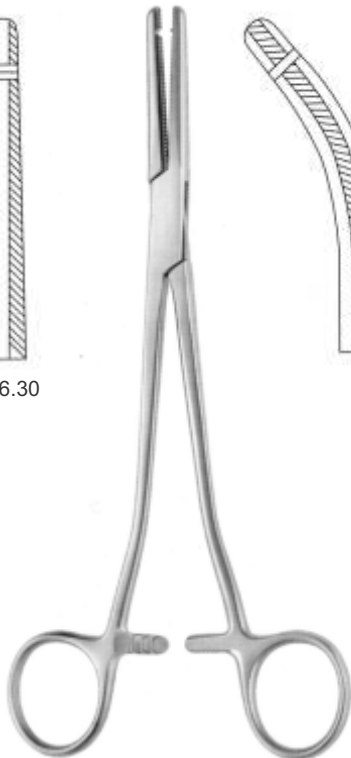

REICH-NECHTOW  
21 cm/ 8¼"



LONG  
TS.05.118.19  
19 cm/ 7½"



**BALLENTINE**  
TS.05.118.31



**HEANEY-  
BALLENTINE**  
TS.05.118.32



**FAURE**  
TS.05.120.23  
23 cm / 9"



**SCHUBERT**  
TS.05.121.24  
24 cm / 9½"

# Gynecology



VAN DOREN  
TS.05.122.24  
24 cm/ 9½"



THOMS-GAYLOR  
TS.05.123.24  
24 cm/ 9½"



PROFESSOR MEDINA  
TS.05.124.22  
22 cm/ 8¾"



GAYLOR  
TS.05.124.24  
24 cm/ 9½"

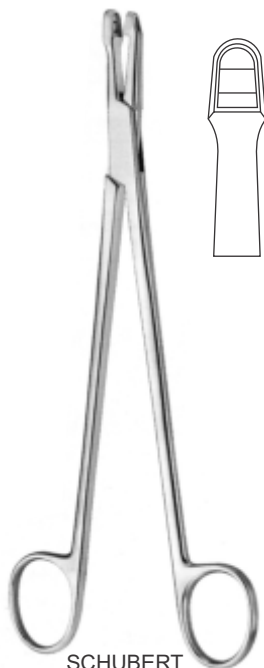

SCHUBERT  
TS.05.125.21  
21 cm/ 8¼"



SCHUBERT  
TS.05.126.21  
21 cm/ 8¼"

# Gynecology



TS.05.126.36  
 # 1- 4 mm



TS.05.126.37  
 # 2- 6 mm

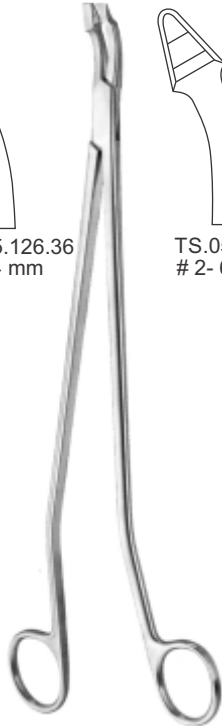

SCHUMACHER-VAN DOREN  
 24 cm/ 9½"

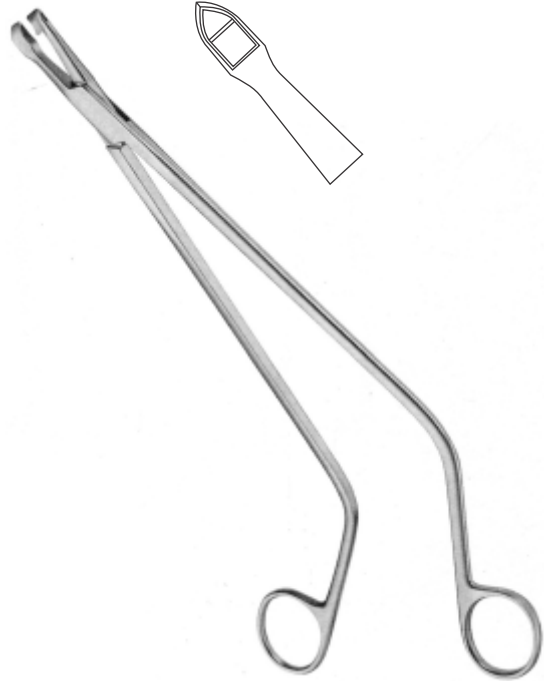

TISCHLER  
 TS.05.126.54  
 27 cm/ 10¾"



TS.05.127.22  
 20 cm-8"  
 Cannula only

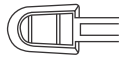

TS.05.127.26  
 Biopsy tip only

TS.05.127.20  
 Universal handle only



EPPENDORF  
 TS.05.127.30

# Gynecology

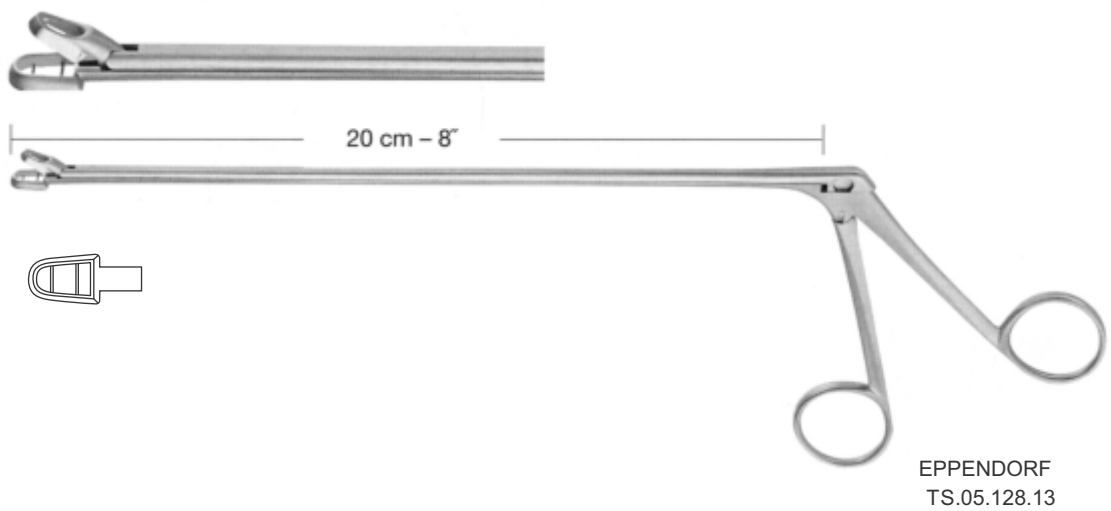
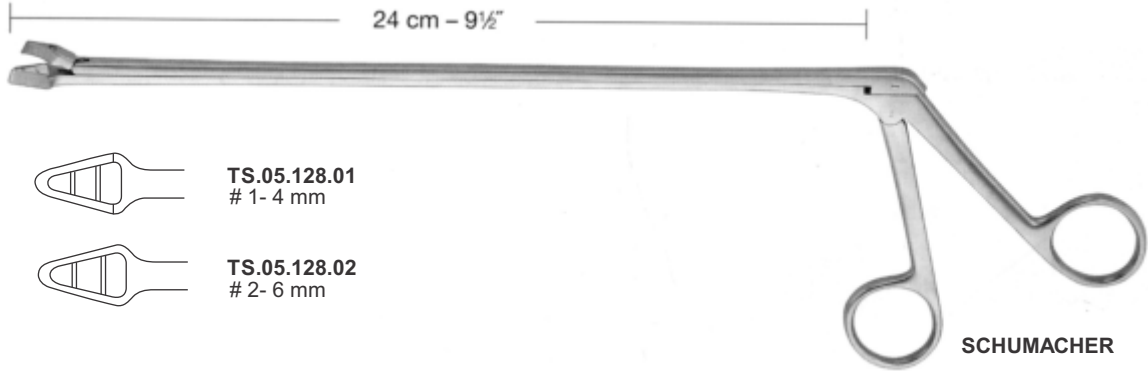

# Gynecology

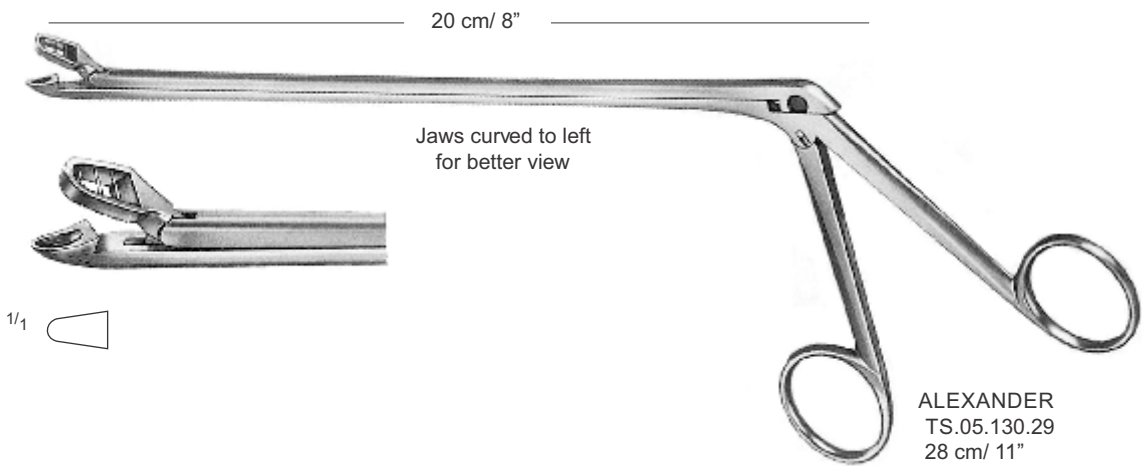
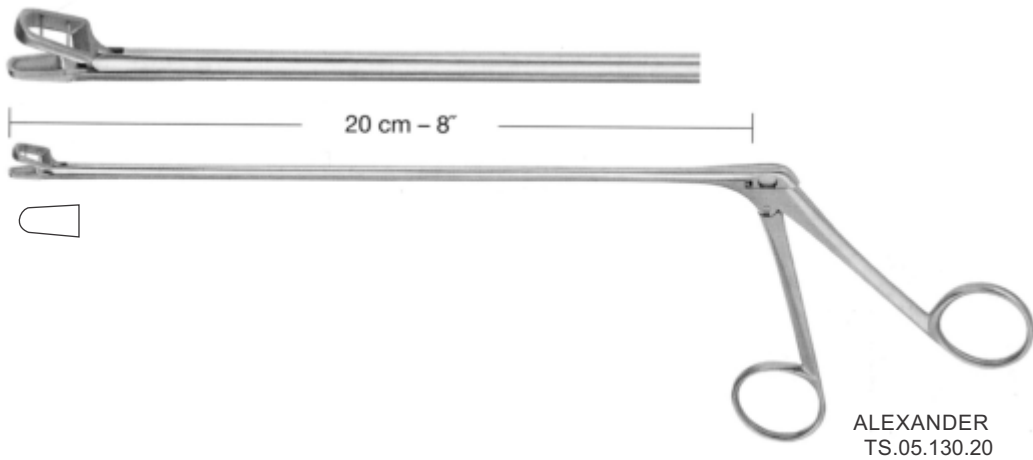
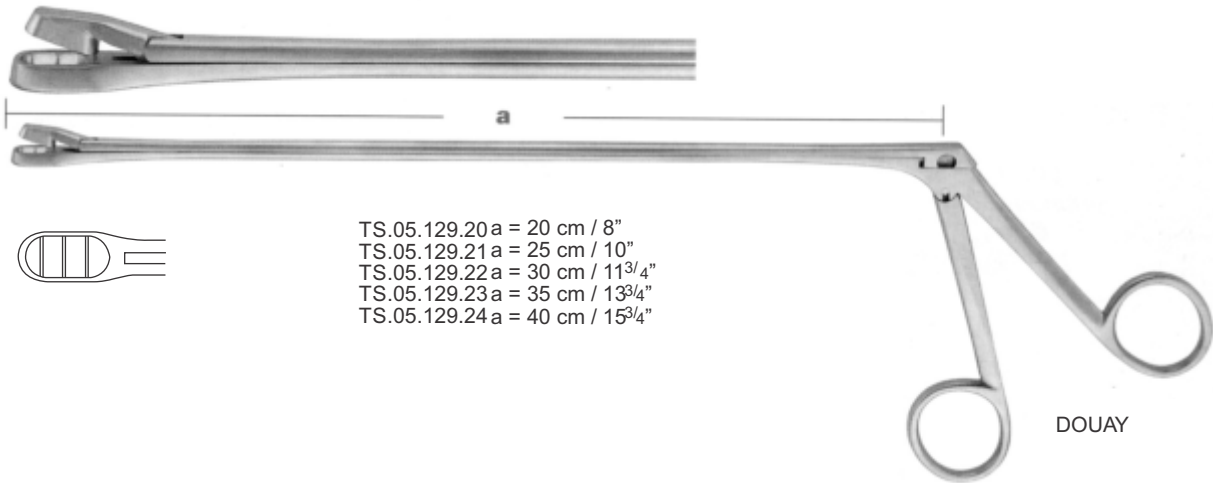



# Gynecology

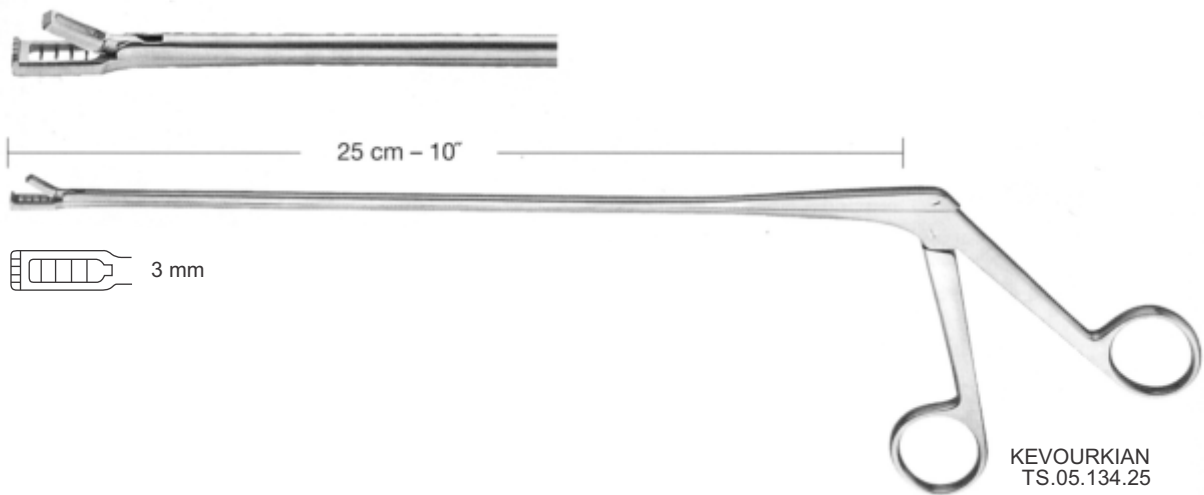
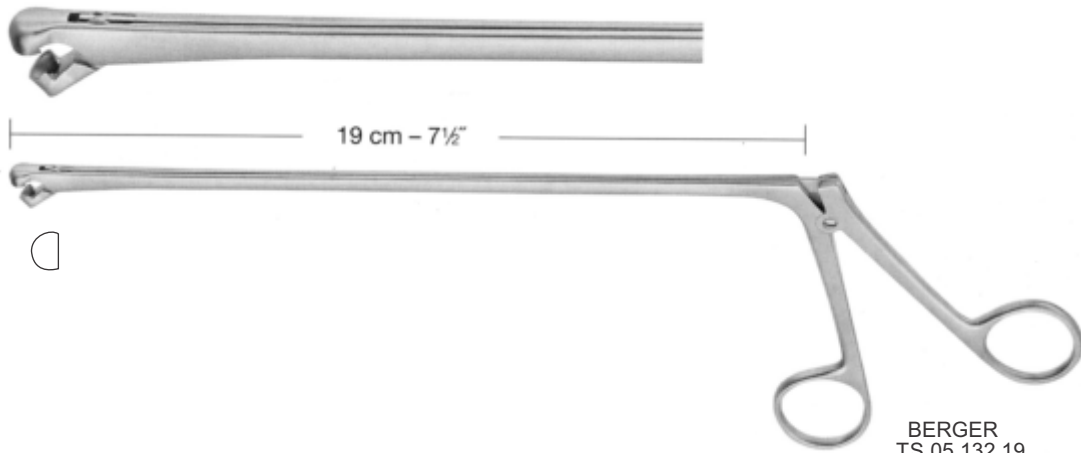

# Gynecology



**COLLIN**  
 28 cm/11"

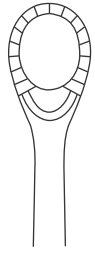

**TS.05.136.08**  
 8 mm



**TS.05.136.10**  
 10 mm



**TS.05.136.12**  
 12 mm

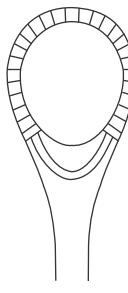

**TS.05.136.14**  
 14 mm



**DOYEN**  
**TS.05.136.29**  
 14 cm/ 5½"

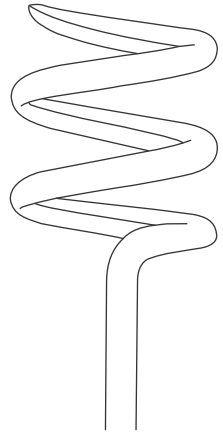

Ø 29mm

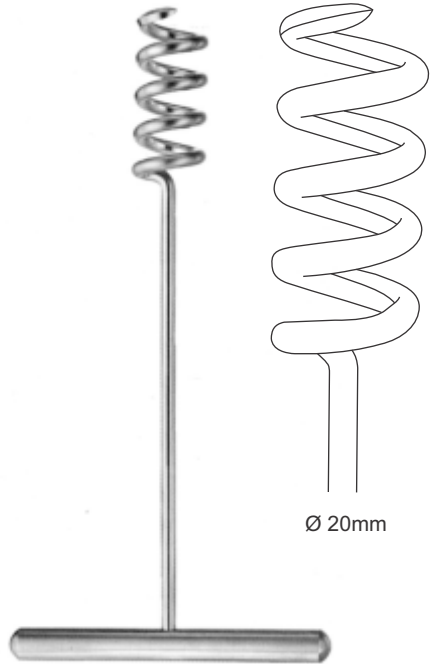

**DOYEN**  
**TS.05.136.20**  
 17 cm/ 6¾"



Ø 20mm



**SEGOND**  
**TS.05.136.50**  
 27 cm/ 10¾"

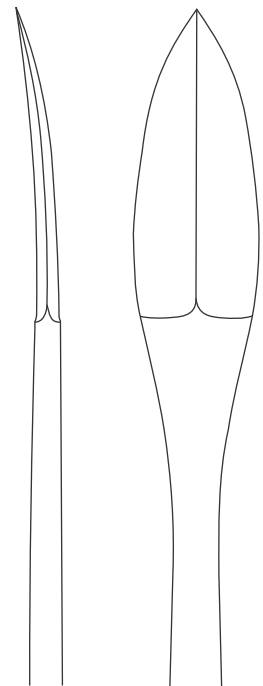

# Gynecology

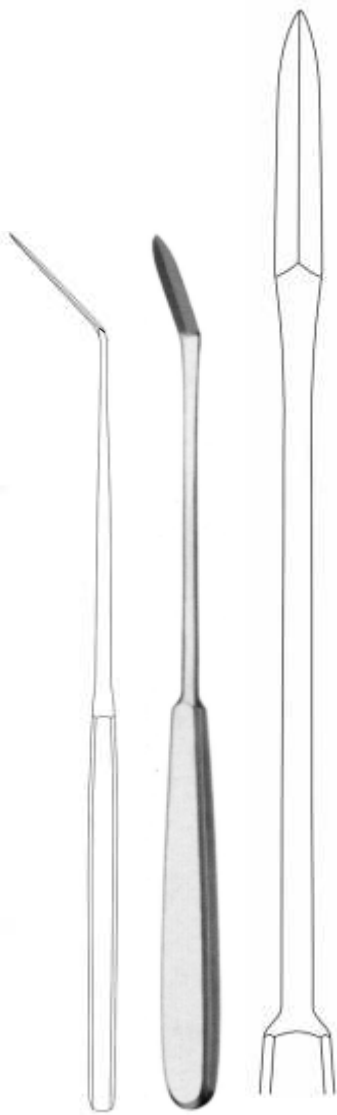

AYRE  
TS.05.136.51  
23 cm/ 9"

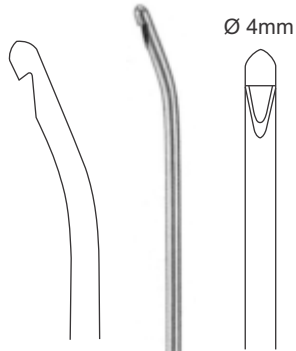

Ø 4mm

Luer-Lock

RANDALL  
TS.05.137.23  
23 cm/ 9"

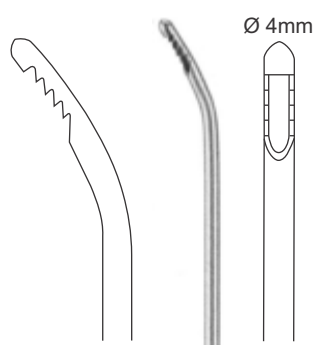

Ø 4mm

Luer-Lock

NOVAK  
TS.05.138.23  
23 cm/ 9"



KEVOURKIAN-YOUNGE  
TS.05.139.30  
30 cm/ 11¾"

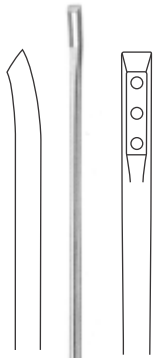

KEVOURKIAN-YOUNGE  
TS.05.140.30  
30 cm / 11¾"

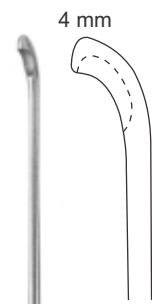

GENELL  
TS.05.142.28  
28 cm / 11"



MOD. MÜNCHEN  
27 cm / 10¾"



TS.05.143.27  
4mm



TS.05.143.20  
5mm

# Gynecology

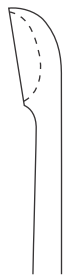

c  
29 cm/ 11½"



TS.05.146.07  
# 1 - 7 mm



TS.05.146.08  
# 2 - 8 mm



TS.05.146.10  
# 3 - 10 mm

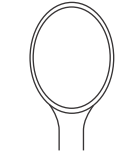

TS.05.146.11  
# 4 - 11 mm

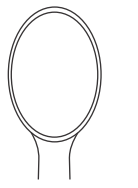

TS.05.146.12  
# 5 - 12 mm

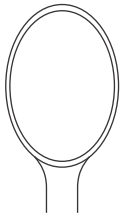

TS.05.146.15  
# 6 - 15 mm



MILAN  
28 cm/ 11"



TS.05.147.04  
# 1 - Ø 4 mm



TS.05.147.06  
# 2 - Ø 6 mm



TS.05.147.09  
# 3 - Ø 9 mm

Slightly malleable

# Gynecology

sharp



rigid

1/2

**SCHROEDER**  
30 cm / 11 3/4"

TS.05.148.01  
#1 - 7 mm

TS.05.148.02  
#2 - 8 mm

TS.05.148.03  
#3 - 10 mm

TS.05.148.04  
#4 - 11 mm

TS.05.148.05  
#5 - 12 mm

1/1

TS.05.148.06  
#6 - 15 mm

blunt



malleable

**THOMAS**  
28 cm / 11"

TS.05.149.01  
#1 - 10 mm

TS.05.149.02  
#2 - 11 mm

TS.05.149.03  
#3 - 12 mm

TS.05.149.04  
#4 - 13 mm

TS.05.149.05  
#5 - 14 mm

TS.05.149.06  
#6 - 15 mm

# Gynecology



TS.05.149.14  
4.5 mm  
Fig # 1



TS.05.149.17  
6 mm  
Fig # 2



TS.05.149.22  
7.5 mm  
Fig # 3

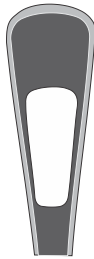

TS.05.149.26  
9 mm  
Fig # 4

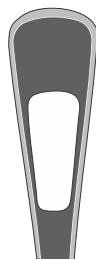

TS.05.149.29  
12 mm  
Fig # 5

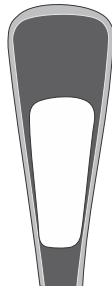

TS.05.149.35  
15 mm  
Fig # 6

J.O.MW UTERINE CURETTES  
28 cm/ 11"



sharp



# 0 - 5 mm

SIMS (HERRERA)  
TS.05.151.80  
25 cm/ 10"



blunt



GOURDET  
28 cm/ 11"



TS.05.152.06  
6 mm



TS.05.152.10  
10 mm

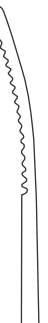

blunt



malleable

GREENE  
28 cm/ 11"



TS.05.151.10  
10 mm

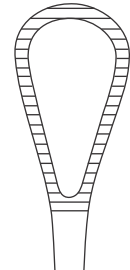

TS.05.151.14  
14 mm



TS.05.151.12  
12 mm



TS.05.152.08  
8 mm



TS.05.152.12  
12 mm



TS.05.152.14  
14 mm

# Gynecology



SIMS  
 24.5 - 26 cm  
 9¾" - 10¼"

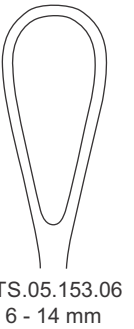
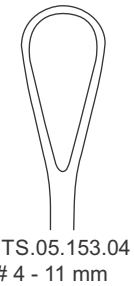
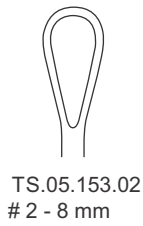
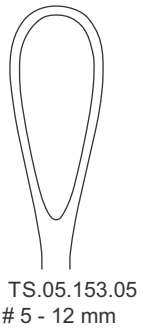
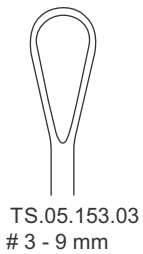
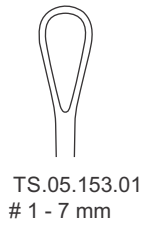

SIMS  
 24.5 - 26 cm  
 9¾" - 10¼"

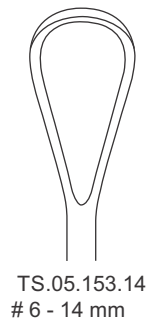
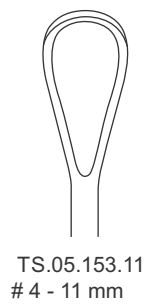
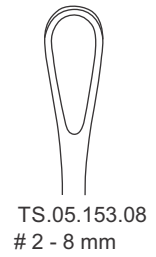
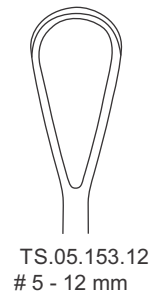
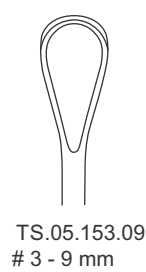
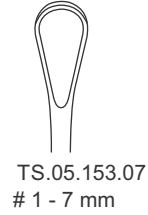



# Gynecology



sharp



RECAMIER  
31 cm/ 12"



rigid



TS.06.155.00  
# 00 - 5 mm



TS.06.155.10  
# 0 - 6 mm



TS.06.155.11  
# 1 - 7 mm



TS.06.155.12  
# 2 - 8 mm



TS.06.155.13  
# 3 - 9 mm



TS.06.155.14  
# 4 - 11 mm



TS.06.155.15  
# 5 - 12 mm



TS.06.155.16  
# 6 - 14 mm

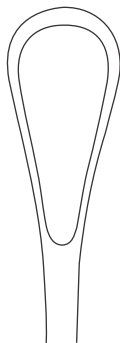

TS.06.155.17  
# 7 - 15 mm

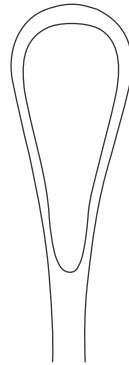

TS.06.155.18  
# 8 - 16 mm

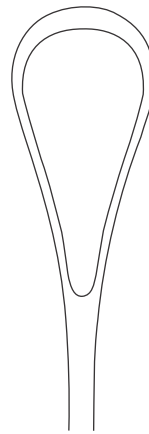

TS.06.155.19  
# 9 - 19 mm

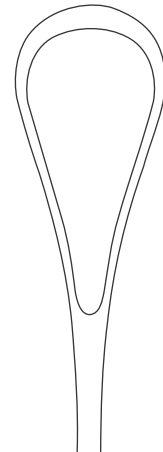

TS.06.155.20  
# 10 - 20 mm

# Gynecology



sharp



RECAMIER  
 31 cm / 12"



malleable



TS.06.155.26  
 # 0 - 6 mm



TS.06.155.27  
 # 1 - 7 mm



TS.06.155.28  
 # 2 - 8 mm



TS.06.155.29  
 # 3 - 9 mm



TS.06.155.31  
 # 4 - 11 mm



TS.06.155.32  
 # 5 - 12 mm



TS.06.155.34  
 # 6 - 14 mm

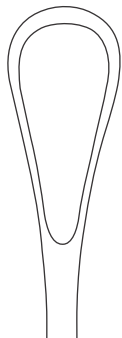

TS.06.155.35  
 # 7 - 15 mm

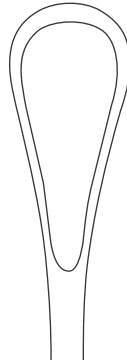

TS.06.155.36  
 # 8 - 16 mm

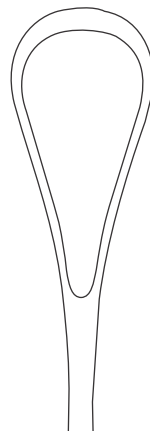

TS.06.155.39  
 # 9 - 19 mm

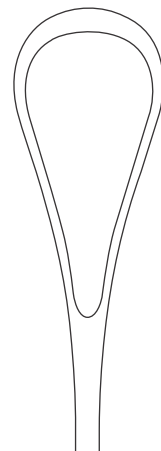

TS.06.155.40  
 # 10 - 20 mm

# Gynecology



blunt



RECAMIER  
31 cm / 12"



TS.06.156.00  
# 00 - 5 mm



TS.06.156.10  
# 0 - 6 mm



TS.06.156.11  
# 1 - 7 mm



TS.06.156.12  
# 2 - 8 mm



TS.06.156.13  
# 3 - 9 mm



TS.06.156.14  
# 4 - 11 mm



TS.06.156.15  
# 5 - 12 mm



TS.06.156.16  
# 6 - 14 mm



rigid

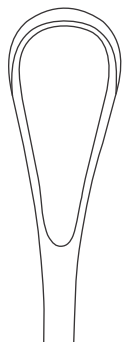

TS.06.156.17  
# 7 - 15 mm

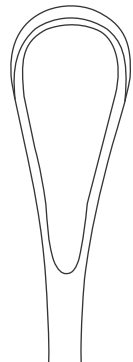

TS.06.156.18  
# 8 - 16 mm

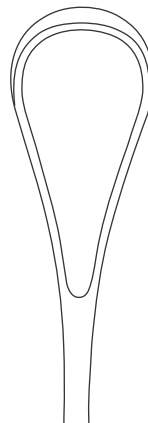

TS.06.156.19  
# 9 - 19 mm

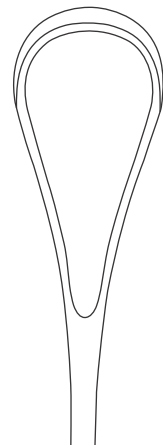

TS.06.156.20  
# 10 - 20 mm

# Gynecology



blunt



malleable



RECAMIER  
 31 cm/ 12"



TS.06.156.26  
 # 0 - 6 mm



TS.06.156.27  
 # 1 - 7 mm



TS.06.156.28  
 # 2 - 8 mm



TS.06.156.29  
 # 3 - 9 mm



TS.06.156.31  
 # 4 - 11 mm



TS.06.156.32  
 # 5 - 12 mm



TS.06.156.34  
 # 6 - 14 mm

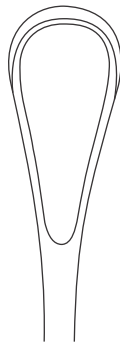

TS.06.156.35  
 # 7 - 15 mm

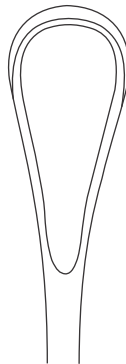

TS.06.156.36  
 # 8 - 16 mm

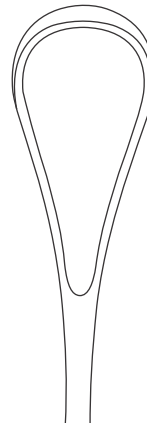

TS.06.156.39  
 # 9 - 19 mm

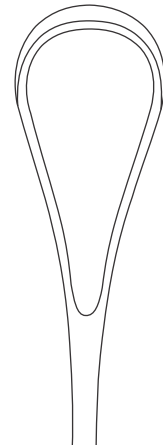

TS.06.156.40  
 # 10 - 20 mm

# Gynecology



blunt



**BUMM**  
28 - 31cm  
11" - 12"

malleable

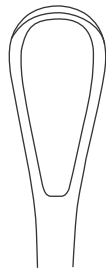

TS.06.158.10  
# 0 - 10 mm

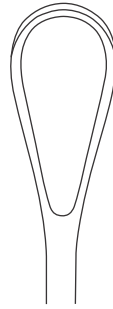

TS.06.158.11  
# 1 - 11 mm

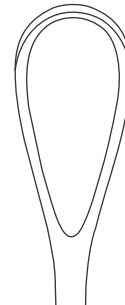

TS.06.158.12  
# 2 - 13 mm

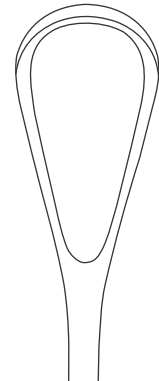

TS.06.158.13  
# 3 - 15 mm

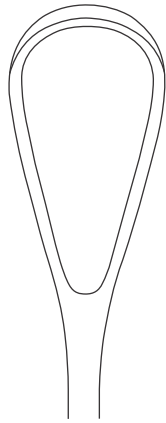

TS.06.158.14  
#4 - 17 mm

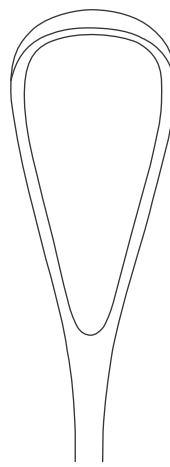

TS.06.158.15  
# 5 - 19 mm

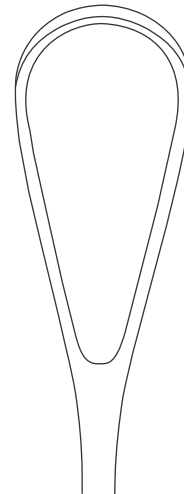

TS.06.158.16  
# 5 - 21 mm

# Gynecology

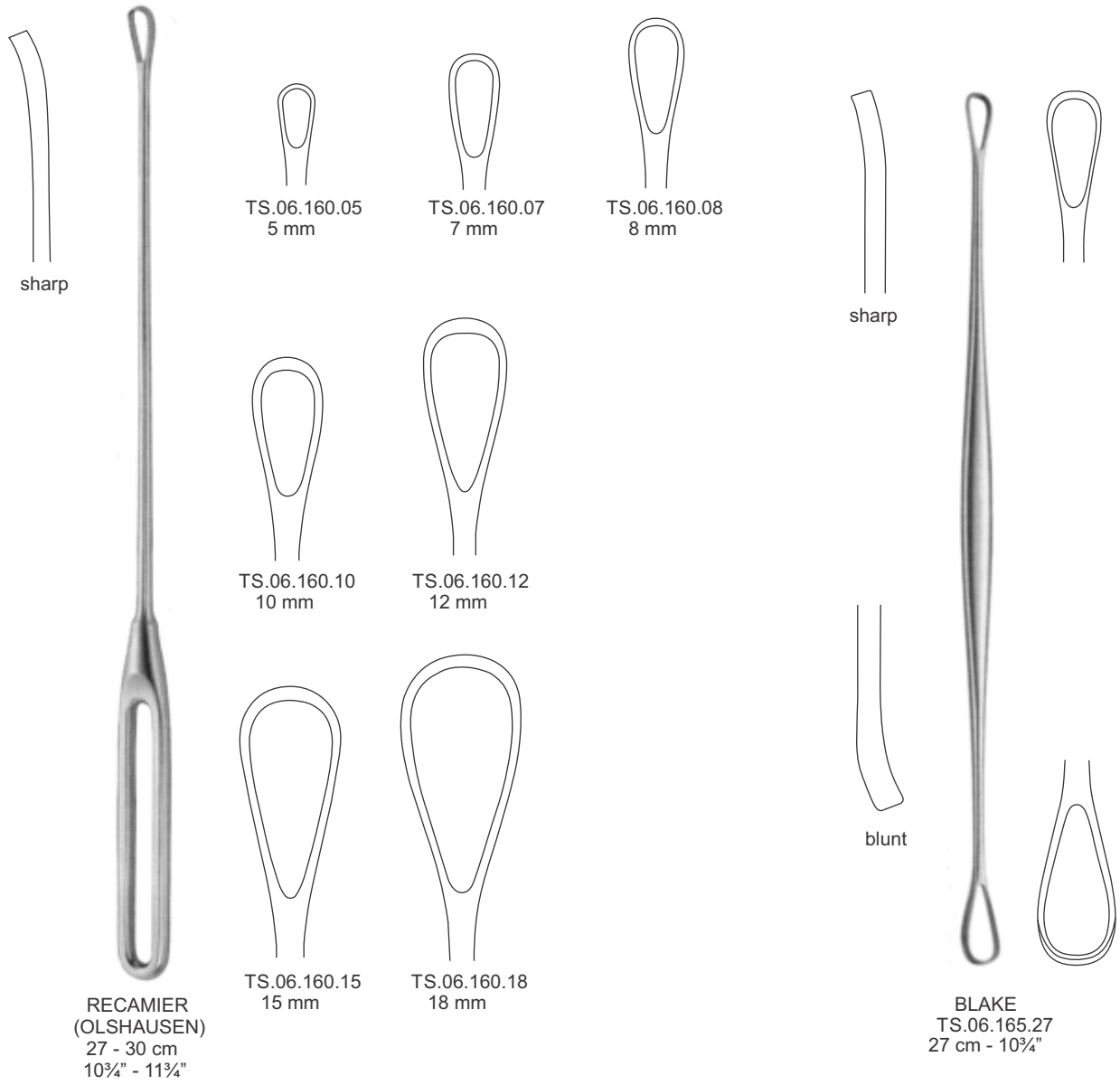





graduated in cm and inches

TS.06.01.15



graduated in cm

MARTIN  
TS.06.03.35

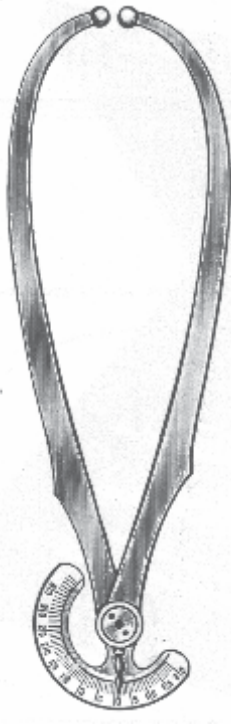

graduated in cm

COLLIN  
TS.06.02.25



# Obstetrics

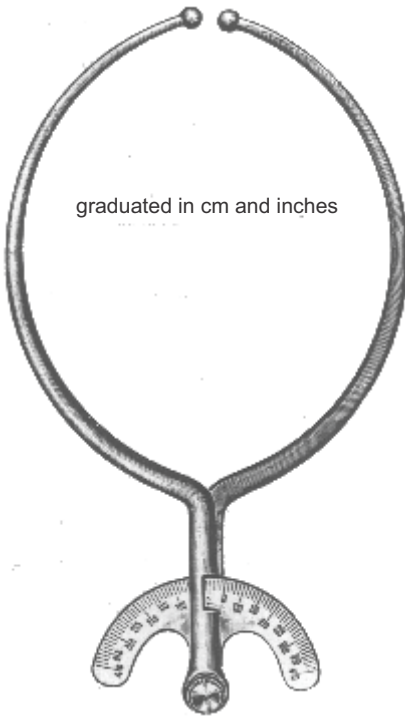

graduated in cm and inches

**BREISKY**  
TS.06.04.45



**DELEE**  
TS.06.05.55  
graduated in cm and inches



Amniotome

**BEACHAM**  
TS.06.06.24  
24 cm / 9½"

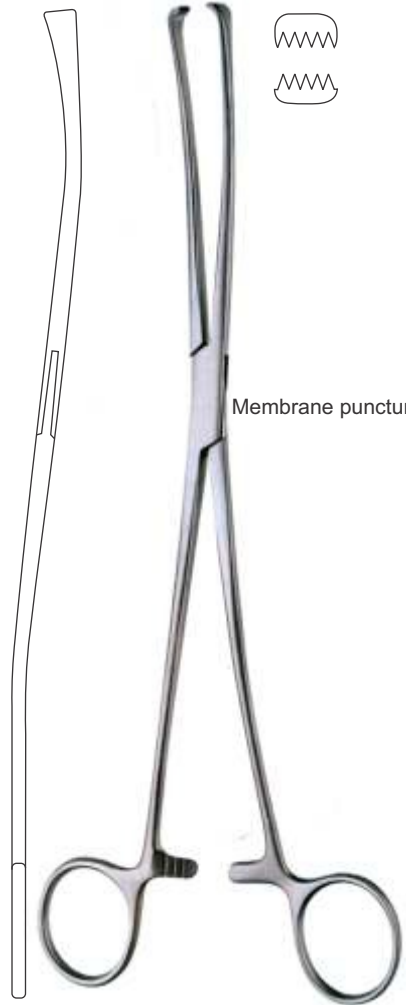

Membrane puncturing

**IOWA**  
TS.06.07.26  
26 cm / 10¼"



**DEMARTEL**  
TS.06.08.14  
14 cm / 5½"



**WILLETT**  
TS.06.08.19  
19 cm / 7½"

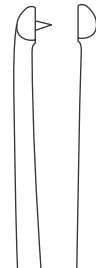
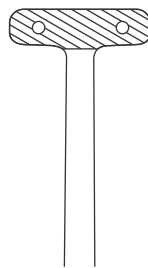



GREEN-ARMYTAGE  
 TS.06.09.22  
 20.5 cm/ 8"



GREEN-ARMYTAGE  
 TS.06.09.23  
 20.5 cm/ 8"



DELEE  
 TS.06.12.36  
 36 cm/ 14 1/8"



Cannula for trans-vaginal  
 anaesthesia of the pudendum

LUER-LOCK  
 TS.06.10.09  
 0.90 x 150 mm



Needle guide (trumpet shaped)

IOWA  
 TS.06.11.14  
 14 cm/ 5 1/2"



SIMPSON  
TS.06.13.32 30 cm/ 11 $\frac{3}{4}$ "  
TS.06.13.36 36 cm/ 14 $\frac{1}{8}$ "



LUIKART-SIMPSON  
TS.06.14.36  
36 cm/ 14 $\frac{1}{8}$ "

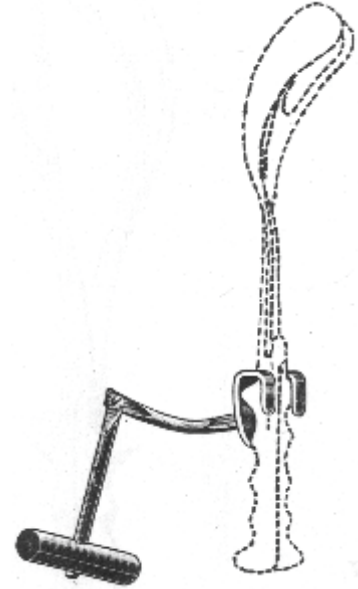

BILL  
TS.06.16.10

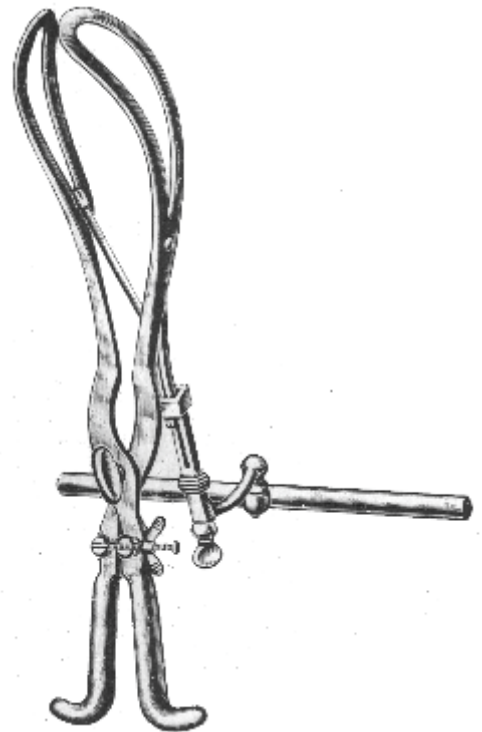

TARNIER  
TS.06.15.40  
40 cm/ 15 $\frac{1}{4}$ "



KIELLAND  
TS.06.17.40  
40 cm/ 15 $\frac{3}{4}$ "



KIELLAND-LUIKART  
TS.06.18.40  
40 cm/ 15 $\frac{3}{4}$ "



PIPER  
TS.06.19.44  
44 cm/ 17 $\frac{1}{2}$ "

# Obstetrics



**KIELLAND-LUIKART**  
TS.06.20.38  
38 cm / 15"



**BRAUN-STADLER**  
TS.06.20.15 15 cm / 6"  
TS.06.20.18 18 cm / 7 1/8"  
TS.06.20.21 21 cm / 8 1/4"  
TS.06.20.22 22 cm / 9"

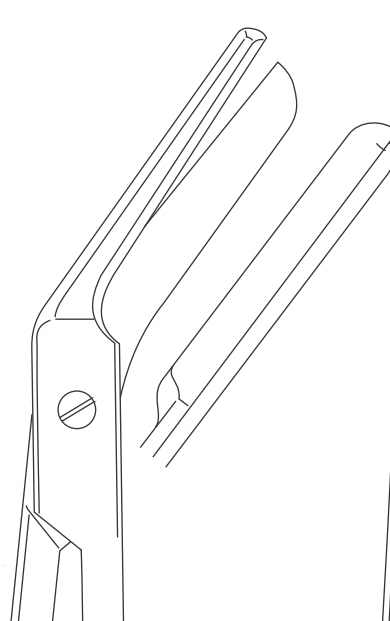

TS.06.20.15

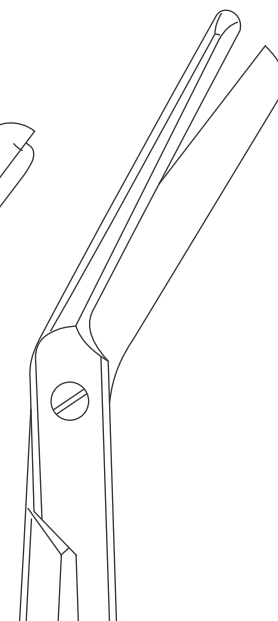

TS.06.20.21



**WALDMANN**  
18 cm / 7 1/8"  
TS.06.21.18  
Standard  
TS.06.21.118  
Supercut



SIMPSON  
TS.06.21.23  
23 cm/ 9"



WRIGLEY  
TS.06.22.28  
28 cm/ 11"



BOERMA  
TS.06.22.35  
28 cm/ 11"

Obstetrical spoon  
Geburtslöffel  
Cuchara obstétrica  
Cuiller obstétricale  
Cucchiaio ostetrico



NAEGELE  
TS.06.23.35 35 cm/ 13¾"  
TS.06.23.40 40 cm/ 15¾"

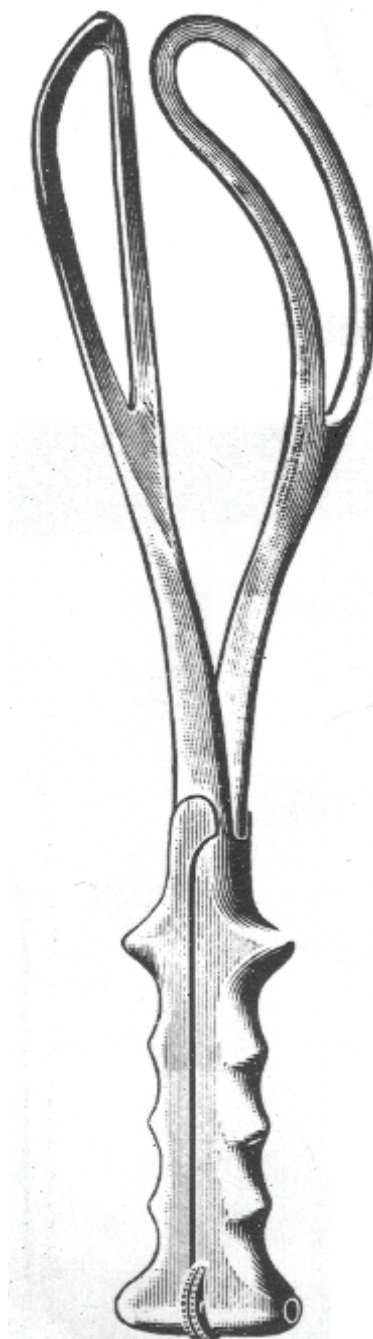

ELLIOT  
TS.06.24.32 32 cm/ 12½"  
TS.06.24.38 38 cm/ 15"



SELLHEIM  
TS.06.25.28  
28 cm/ 11"



SELLHEIM  
TS.06.25.30  
30 cm / 12"



SMELLIE  
TS.06.26.30  
30 cm / 11¼"

Decapitation Hook



BRAUN  
TS.06.27.31  
31 cm / 12"

Cranioclast



BRAUN  
TS.06.28.42  
42 cm / 16½"

Perforator



SMELLIE  
TS.06.30.27  
27 cm / 10¾"  
Perforator



# Obstetrics



UMBILICAL  
TS.06.32.11  
10.5 cm/ 4¼"

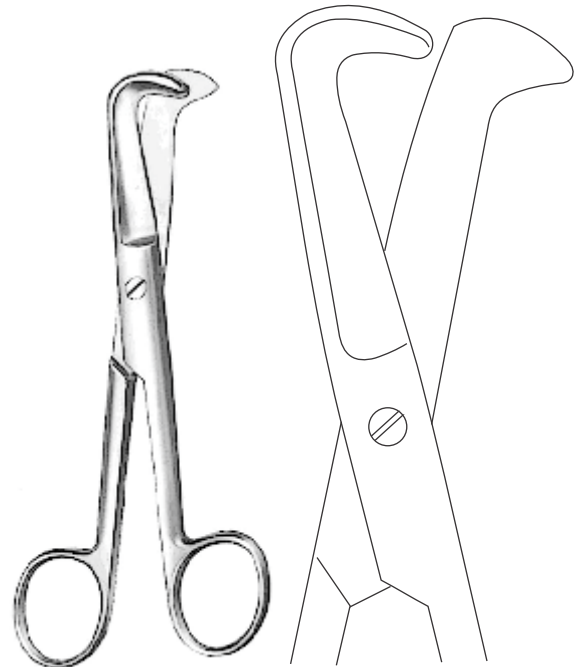

SCHUMACHER  
TS.06.33.16  
16 cm/ 6¼"

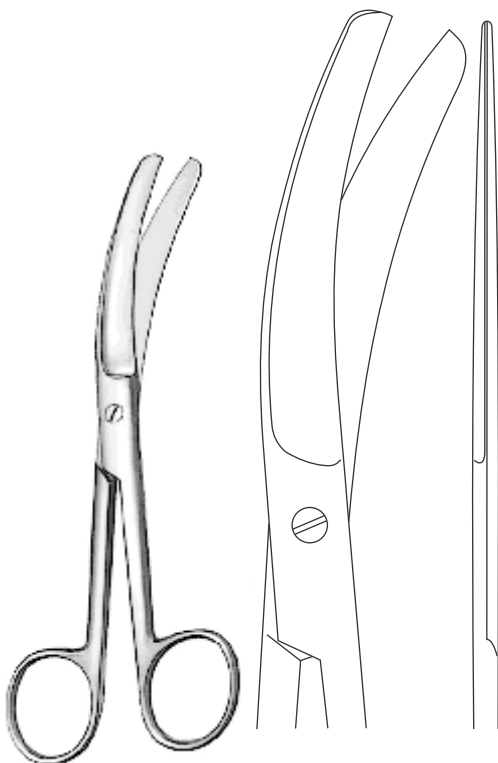

BUSCH  
TS.06.34.13 13 cm/ 5⅞"  
TS.06.34.16 16 cm/ 6¼"  
TS.06.34.47 16 cm/ 6¼" one serrated blade

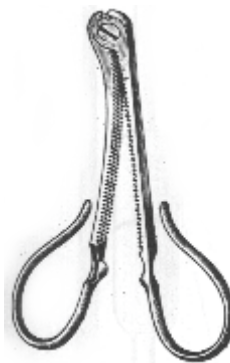

KANE  
TS.06.35.09  
8.5 cm/ 3¼"



COLLIN  
TS.06.36.09  
8.5 cm/ 3¼"

Umbilical cord clamp



LOVSET  
TS.06.38.25  
package/100 pieces

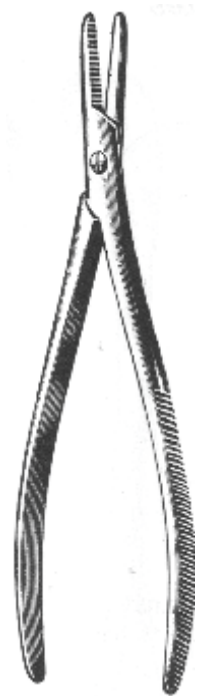

LOVSET  
TS.06.37.20  
20 cm/ 7¼"

# Obstetrics



WINTER  
 28 cm/ 11"

TS.06.39.01  
 # 1 - 8 mm



TS.06.39.02  
 # 2 - 10 mm



TS.06.39.03  
 # 3 - 14 mm



WINTER  
 28 cm/ 11"

TS.06.40.10  
 # 1 - 8 mm



TS.06.40.12  
 # 2 - 10 mm



TS.06.40.15  
 # 3 - 14 mm

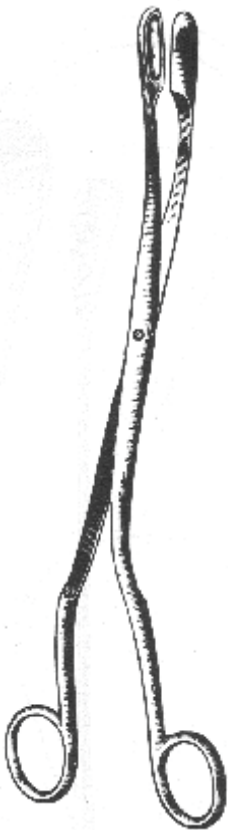
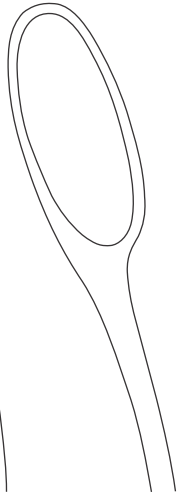

WINTER  
 TS.06.41.27  
 27 cm/ 10 1/4"  
 14 mm

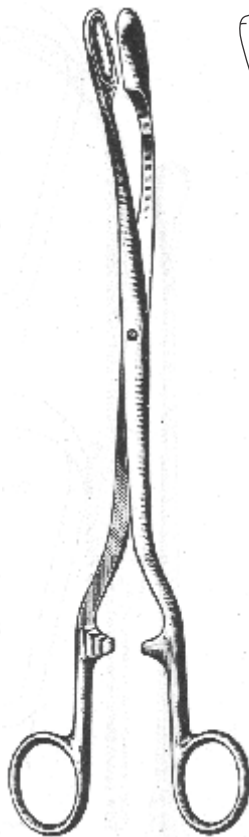

WINTER  
 28 cm/ 11"  
 TS.06.42.32 #2-10 mm  
 TS.06.42.33 #3-14 mm

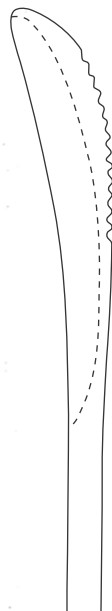

CUZZI  
 30 cm/ 11 3/4"

TS.06.43.01  
 # 1 - 14 mm



TS.06.43.02  
 # 2 - 18 mm



TS.06.43.03  
 # 3 - 21 mm

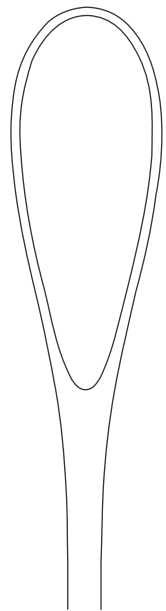

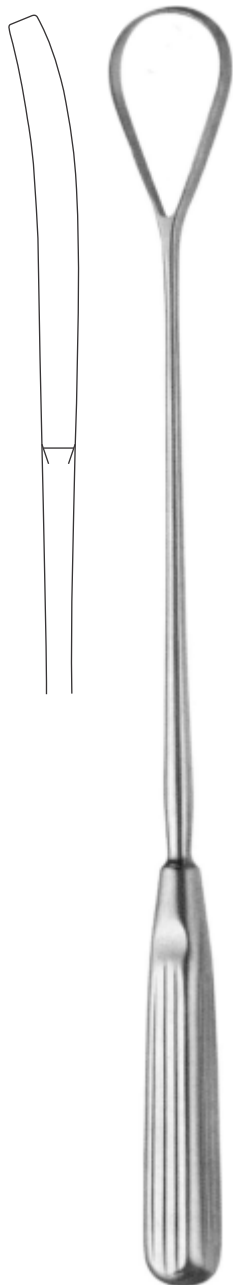

RECAMIER

TS.06.43.11  
sharp

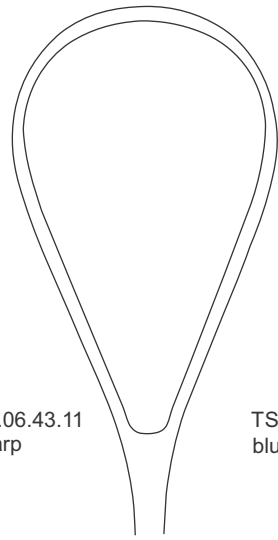

35 mm  
34 cm/13 3/8"

TS.06.43.15  
blunt

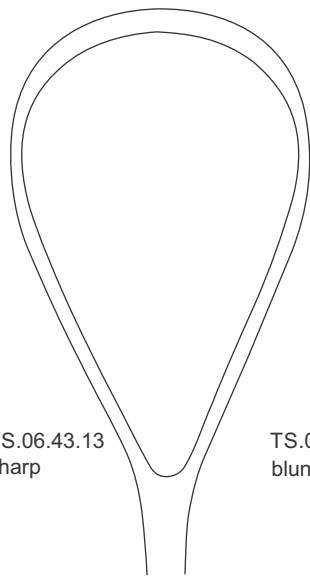

40 mm  
35 cm - 13 3/4"

TS.06.43.13  
sharp

TS.06.43.17  
blunt

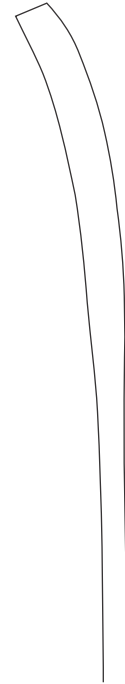

sharp



BUMM (RECAMIER)  
TS.06.43.24 24 mm  
TS.06.43.26 26 mm  
TS.06.43.28 28 mm  
30-31 cm

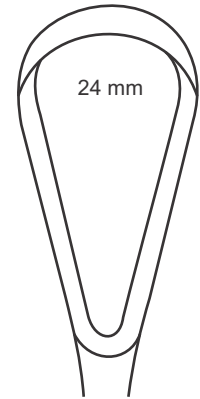

24 mm

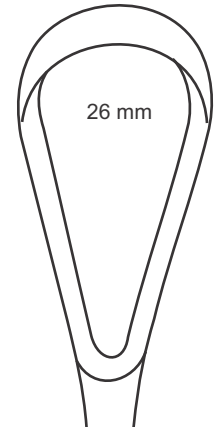

26 mm

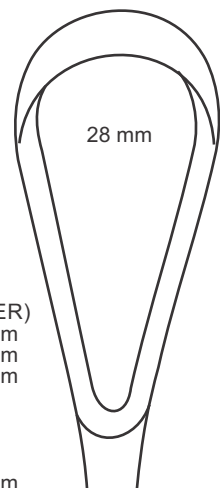

28 mm

blunt

TS.06.43.44 24 mm  
TS.06.43.46 26 mm  
TS.06.43.48 28 mm  
30-31 cm



WALLICH  
 TS.06.44.42  
 42 cm / 16½"

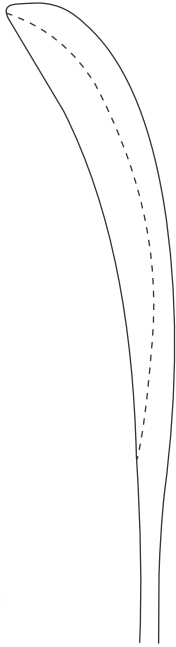

19 mm

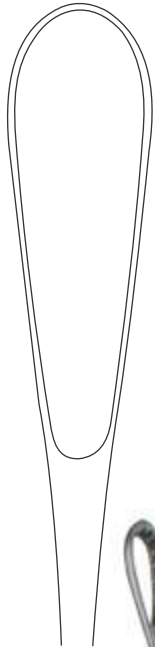

SAENGER  
 29 cm / 11¼"

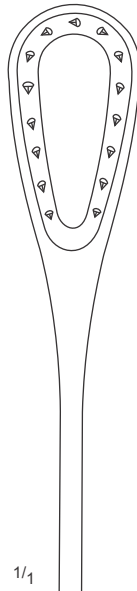

1/1  
 TS.06.45.28  
 17 mm

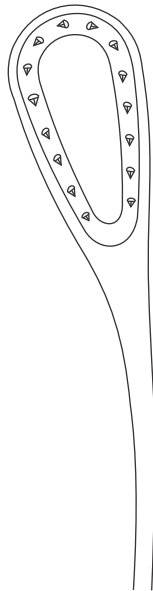

TS.06.45.29  
 17 mm



SAENGER  
 27 cm / 10¾"

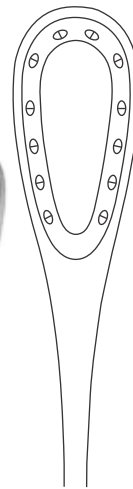

TS.06.46.27  
 18 mm

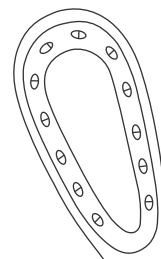

TS.06.47.27  
 18 mm

# Obstetrics

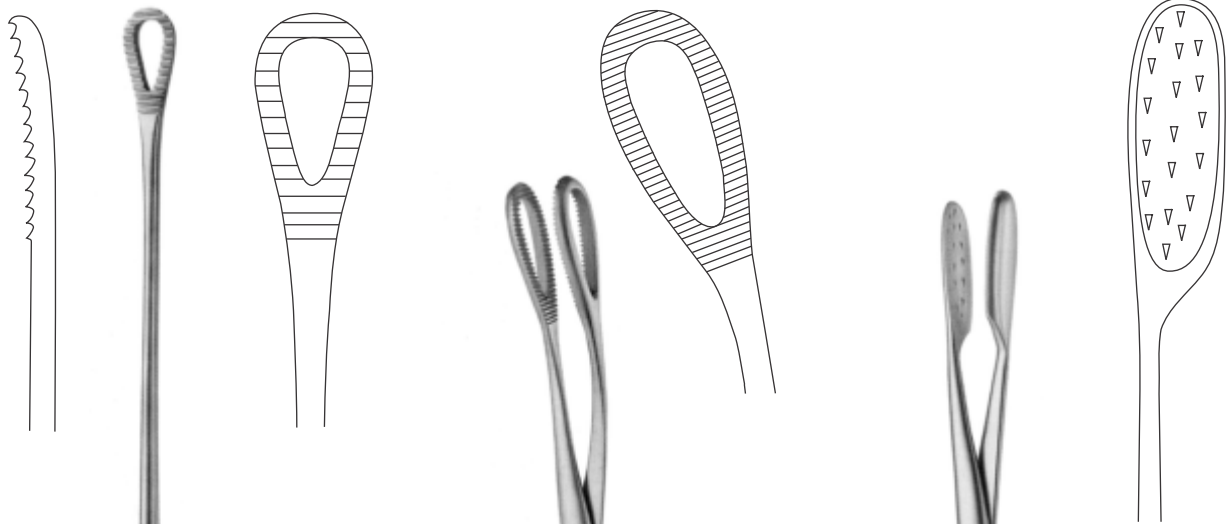

PESTALOZZA  
TS.06.47.40  
30 cm/ 11¼"

MCCLINTOCK  
TS.06.48.24  
24 cm/ 9½"

LEWKOWITZ  
TS.06.49.40  
24 cm/ 9½"



# Bandage and Plaster Cast Instruments



STILLE  
TS.06.01.23 23 cm/ 9"  
TS.06.01.26 26 cm/ 10¼"  
TS.06.01.37 37 cm/ 14½"

TS.06.01.73  
Spare Blade for TS.06.01.23

TS.06.01.77  
Spare Blade for TS.06.01.37

TS.06.01.76  
Spare Blade for TS.06.01.26



STILLE  
TS.06.02.37  
37 cm/ 14½"  
TS.06.02.77  
Spare Blade For TS.06.02.37

# Bandage and Plaster Cast Instruments



MOD.USA  
TS.06.03.23  
23 cm/ 9"



WOLFF BOEHLER  
TS.06.04.18 18 cm/ 7 1/8"  
TS.06.04.24 24 cm/ 9 1/2"



HENNIG  
TS.06.05.27  
27 cm/ 10 3/4"

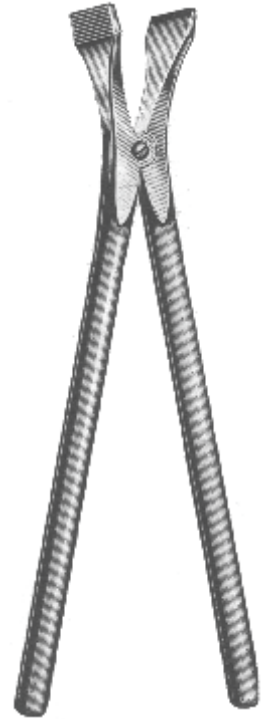

BEESON  
TS.06.06.30  
30 cm/ 11 1/4"

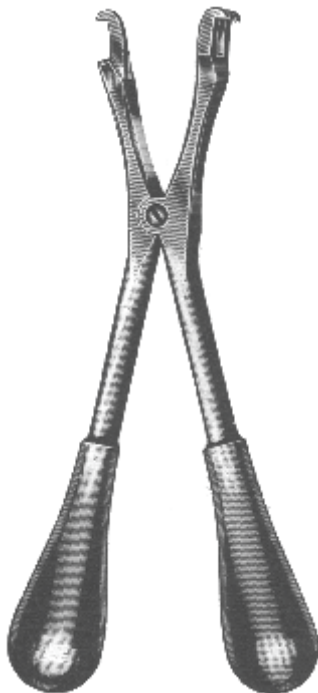

HAGLUND STILLE  
TS.06.07.28  
28 cm/ 11"



WIGMORE  
TS.06.09.19  
19 cm/ 7 1/2"

Plaster Saw



ENGEL  
TS.06.10.15  
15 cm/ 6"



ESMARCH  
TS.06.11.18  
18 cm/ 7 1/8"



# Bandage and Plaster Cast Instruments



SAUERBRUCH  
TS.06.08.55  
55 cm/ 21¾"



HOPKINS  
TS.06.12.20  
20 cm/ 8"



REINER  
TS.06.13.19  
19 cm/ 7½"



STILLE  
TS.06.18.23  
23 cm/ 9"



CARTILAGE  
TS.06.16.21  
21 cm/ 8¼"

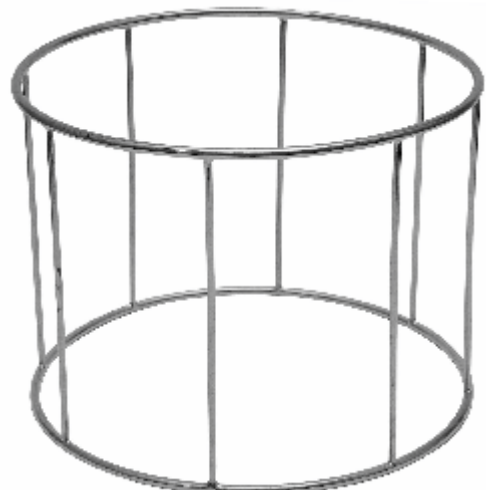

TUBE GAUZE  
TS.06.15.01 Size "A"  
TS.06.15.13 Size "C" 154.00 mm x 36.30 mm  
TS.06.15.14 Size "D" 154.00 mm x 36.30 mm  
TS.06.15.15 Size "E" 154.00 mm x 51.80 mm  
TS.06.15.16 Size "F" 154.00 mm x 130.00 mm  
TS.06.15.27 Size "G" 154.00 mm x 180.00 mm  
TS.06.15.28 Size "H" 154.00 mm x 205.00 mm  
TS.06.15.19 Size "J" 154.00 mm x 233.00 mm  
TS.06.15.26 Size "FX" 154.00 mm x 156.00 mm  
TS.06.15.29 Size "K" 153.00 mm x 252.00 mm



BANDAGE  
TS.06.17.22  
23 cm/ 9"

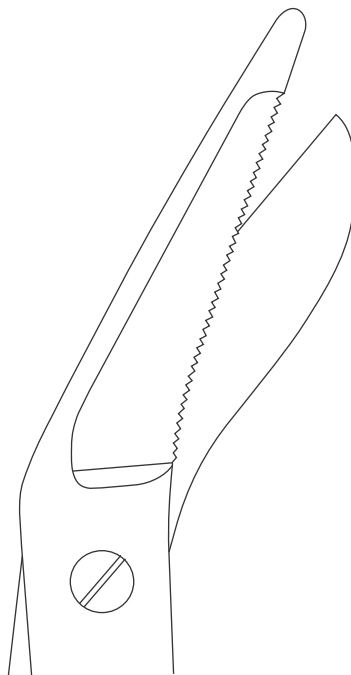

STILLE MINI  
TS.06.19.20  
20 cm/ 8"

# Sterilization

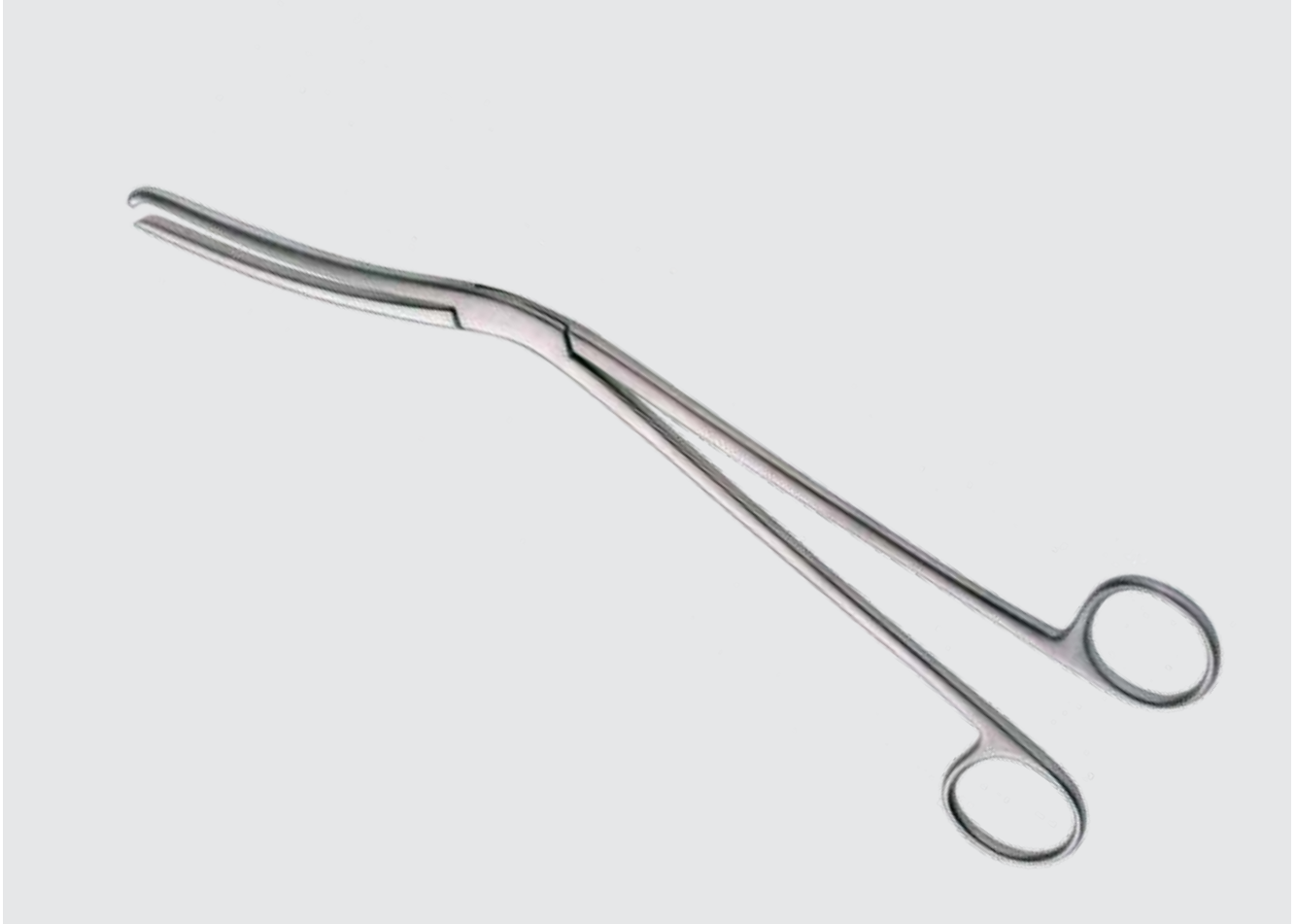

# Sterilization

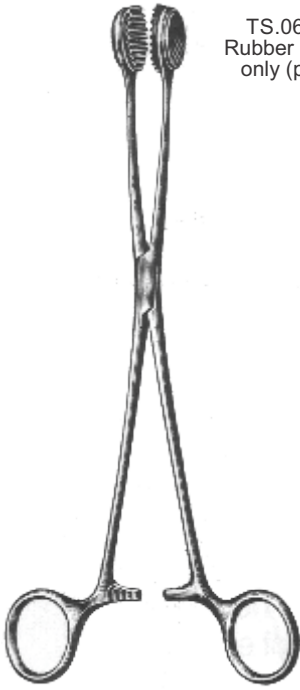

TS.06.01.26  
 Rubber inserts  
 only (pairs)

TS.06.01.24  
 24 cm/ 9½"



ULLEVAL  
 TS.06.02.24  
 24 cm/ 9½"



CHEATTLE  
 TS.06.03.27  
 27 cm/ 10¾"



TS.06.04.20 20 cm/ 8"  
 TS.06.04.28 28 cm/ 11"

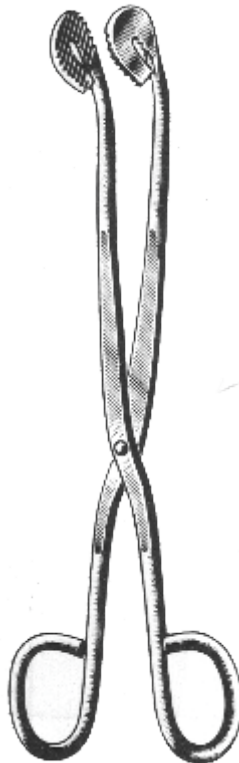

TS.06.05.20 20 cm/ 8"  
 TS.06.05.28 28 cm/ 11"



HAKIE  
 TS.06.08.25  
 for ring handle instruments (without instruments)

# Sterilization



BUNT (MAYO)  
TS.06.10.13  
14 cm/ 5½"



BUNT (MAYO)  
TS.06.10.12  
12 cm/ 4¾"

BUNT (MAYO)  
TS.06.10.14  
14 cm/ 5½"



TS.06.10.23  
16 cm/ 6¼"

TS.06.10.24  
19 cm/ 7½"

TS.06.10.25  
32 cm/ 12½"

KIRSCHNER  
Ø 12 mm



Supplied without wires

for wires up to:

15 cm/ 6"

18 cm/ 7⅛"

31 cm/ 12"



Needle case  
TS.06.19.65  
Ø 65 mm x 15 mm

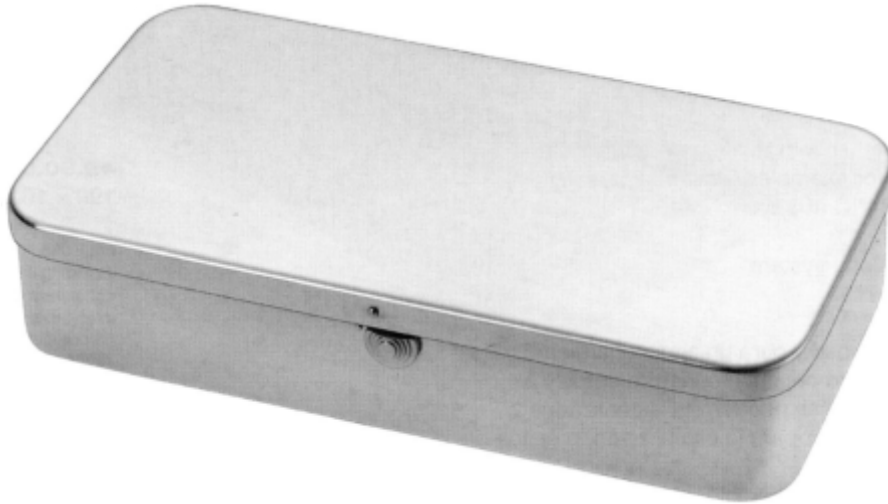

- TS.06.22.20 200 x 100 x 20 mm
  - TS.06.22.30 200 x 100 x 30 mm
  - TS.06.22.40 200 x 100 x 40 mm
  - TS.06.22.50 200 x 100 x 50 mm
- Metal cases, empty with lid and slide lock



Horizontal ventilation

**SCHIMMELBUSCH**

- TS.06.25.14 14 x 14 cm
- TS.06.25.16 16 x 15 cm
- TS.06.25.19 19 x 16 cm
- TS.06.25.20 19 x 19 cm
- TS.06.25.24 24 x 12 cm
- TS.06.25.25 24 x 16 cm
- TS.06.25.27 24 x 24 cm
- TS.06.25.29 29 x 16 cm
- TS.06.25.30 29 x 24 cm
- TS.06.25.34 34 x 16 cm
- TS.06.25.35 34 x 24 cm
- TS.06.25.39 39 x 14 cm
- TS.06.25.40 39 x 19 cm
- TS.06.25.41 39 x 29 cm



Vertical ventilation

**KONRICH**

ø h

- TS.06.26.14 14 x 14 cm
- TS.06.26.16 16 x 15 cm
- TS.06.26.19 19 x 16 cm
- TS.06.26.20 19 x 19 cm
- TS.06.26.24 24 x 12 cm
- TS.06.26.25 24 x 16 cm
- TS.06.26.27 24 x 24 cm
- TS.06.26.29 29 x 16 cm
- TS.06.26.30 29 x 24 cm
- TS.06.26.34 34 x 16 cm
- TS.06.26.35 34 x 24 cm
- TS.06.26.36 35 x 30 cm
- TS.06.26.39 39 x 14 cm
- TS.06.26.40 39 x 19 cm
- TS.06.26.41 39 x 29 cm
- TS.06.26.45 39 x 35 cm

# Suture



# Suture

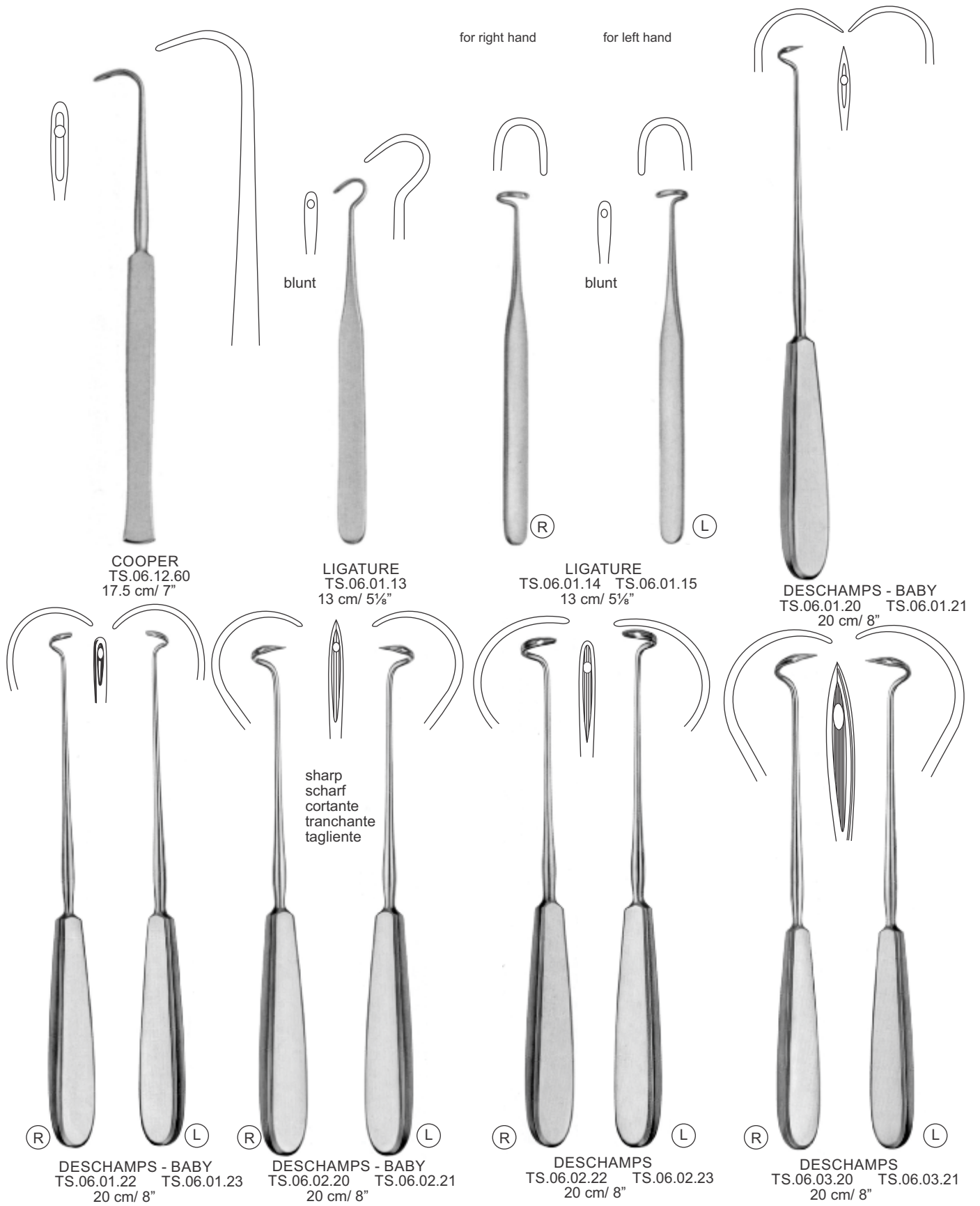



# Suture

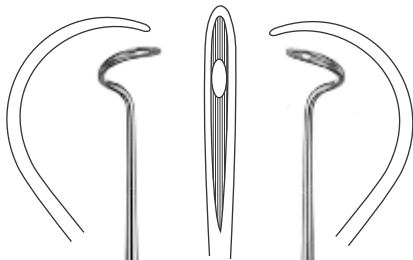

(R)

(L)

DESCHAMPS  
TS.06.03.22 TS.06.03.23  
20 cm/ 8"

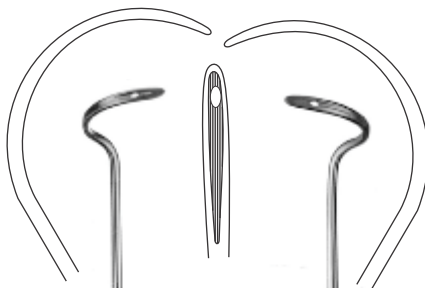
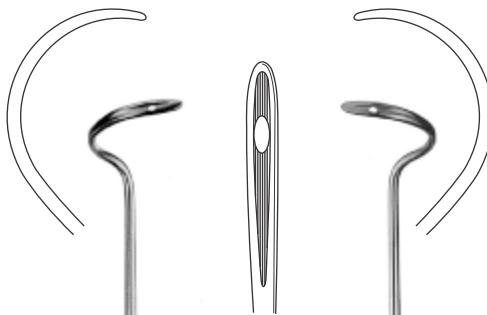

(R)

(L)

DESCHAMPS  
TS.06.03.24 TS.06.03.25  
24 cm/ 9½"

(R)

(L)

DESCHAMPS  
TS.06.04.28 TS.06.04.29  
30 cm/11¾"

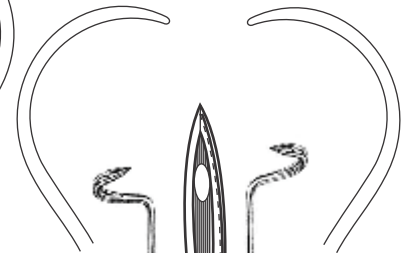

(R)

(L)

DESCHAMPS  
TS.06.05.28 TS.06.05.29  
28 cm/11"

# Suture



Knot tier

BOZEMANN  
 TS.06.08.61  
 21.5 cm/ 8½"



Ligature adjuster

TS.06.08.63  
 23 cm/ 9"



Ligature catcher

MOD. WIEN  
 TS.06.08.64  
 23.5 cm/ 9¼"

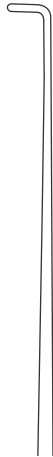

LANGE  
 TS.06.09.10  
 10 cm/ 4"



MICHEL  
 TS.06.10.12  
 12.5 cm/ 5"

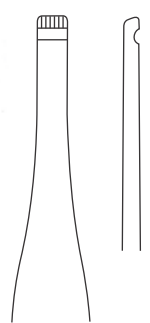

CHILD  
 TS.06.11.17  
 17 cm/ 6¾"

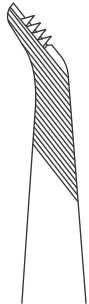

HEGENBARTH  
 TS.06.13.12  
 12 cm/ 4¾"



WACHENFELDT  
 TS.06.14.12  
 12 cm/ 4¾"



WACHENFELDT  
 TS.06.15.12  
 12 cm/ 4¾"



12.5 cm/ 5"

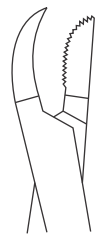

MICHEL  
 TS.06.16.12

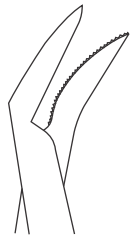

MICHEL  
 MODIF.  
 TS.06.16.13

# Suture



**COLLIN**  
TS.06.17.13  
13 cm / 5 $\frac{1}{8}$ "



**HEATH**  
TS.06.18.14  
13 cm / 5 $\frac{1}{8}$ "

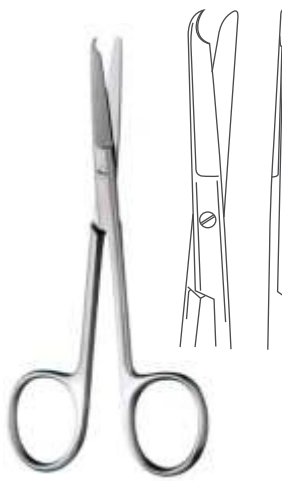

**SPENCER**  
TS.06.19.09  
9 cm / 3 $\frac{1}{2}$ "



**SPENCER**  
TS.06.20.10 – 10.5 cm / 4 $\frac{1}{8}$ "  
TS.06.20.12 – 12 cm / 4 $\frac{3}{4}$ "  
TS.06.20.14 – 14 cm / 5 $\frac{1}{2}$ "

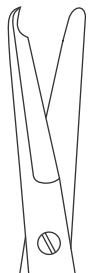

**"TC"**  
TS.06.20.60  
10.5 cm / 4 $\frac{1}{8}$ "

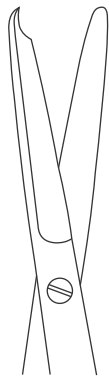

**"TC"**  
TS.06.20.62  
12 cm / 4 $\frac{3}{4}$ "

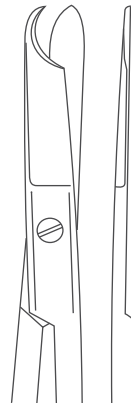

**LITTAUER**  
TS.06.21.13  
13 cm / 5 $\frac{1}{8}$ "

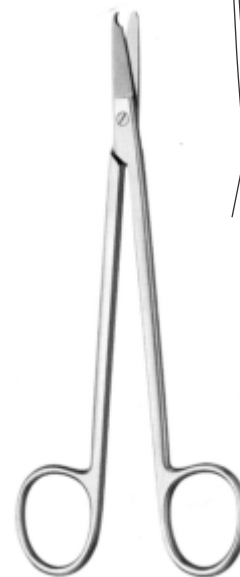

**KELLY**  
TS.06.21.35  
15 cm / 6"

**SPENCER**

**Suture**

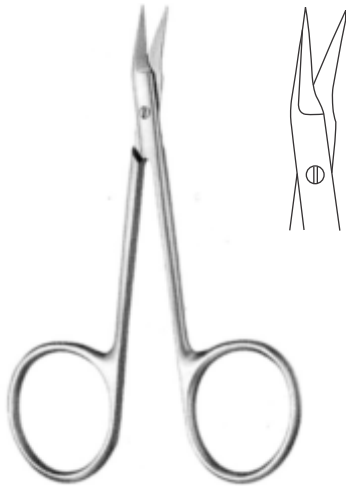

O'BRIEN  
 TS.06.22.09  
 9 cm / 3½"

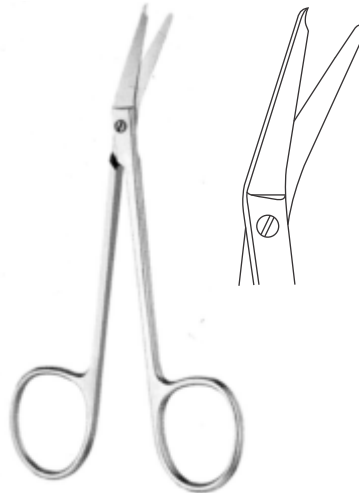

SPENCER  
 TS.06.22.11  
 11.5 cm / 4½"

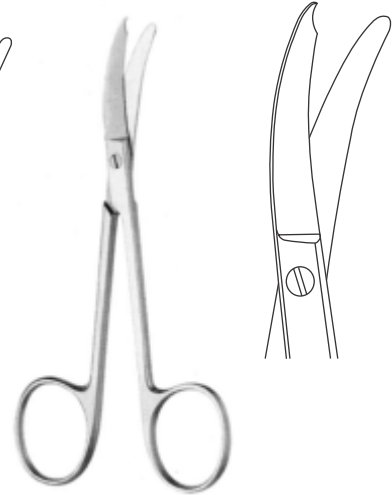

SPENCER  
 TS.06.22.12  
 12 cm / 4¾"

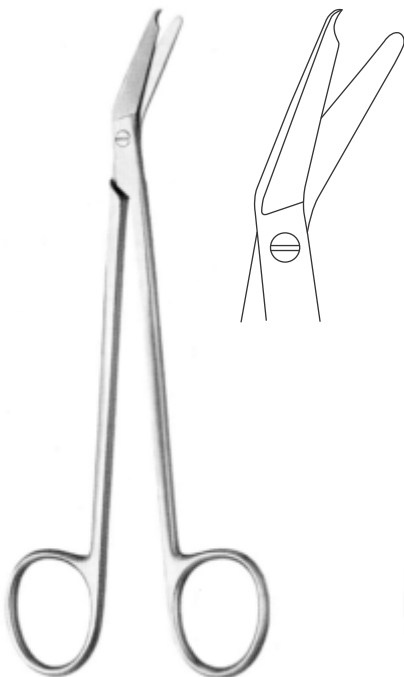

LOCKLIN  
 TS.06.22.15  
 15 cm / 6"



EISELSBERG  
 TS.06.22.91  
 11 cm / 4 3/8"



TS.06.23.84  
 14.5 cm / 4¾"

# Suture

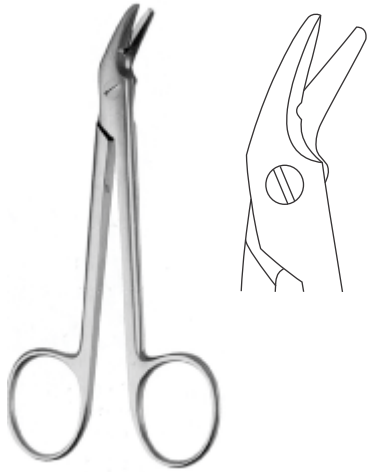

UNIVERSAL  
TS.06.23.12  
12 cm/ 4¾"

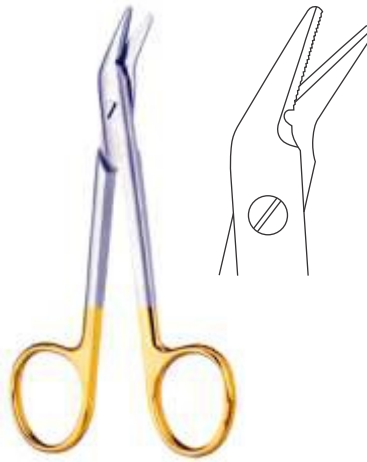

UNIVERSAL "TC"  
TS.06.24.12  
12 cm/ 4¾"



UNIVERSAL "TC"  
TS.06.24.16  
16 cm/ 6¼"

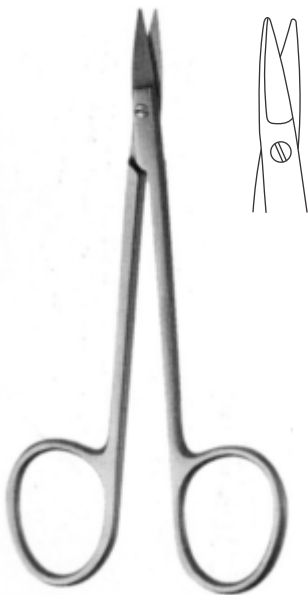

SCHUKNECHT  
TS.06.25.09  
10 cm/ 4"



HARVEY  
TS.06.25.10  
13 cm/ 5⅛"

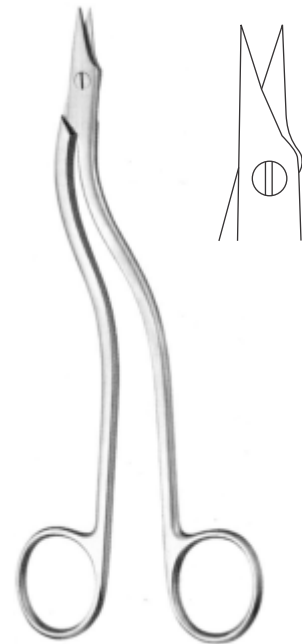

HEATH  
TS.06.25.15  
15 cm/ 6"  
TS.06.25.18  
18 cm/ 7⅛"

# Suture



**BEEBEE**  
 10.5cm/ 4 1/4"

serrated



TS.06.26.10



TS.06.26.20



TS.06.28.10



TS.06.28.20



TS.06.27.10



TS.06.27.20



TS.06.29.10



TS.06.29.20



**BEEBEE**  
 12.5 cm - 5"



TS.06.26.12



TS.06.26.22



TS.06.28.12



TS.06.28.22



TS.06.27.12

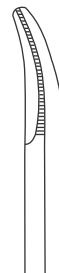

TS.06.27.22



TS.06.29.12

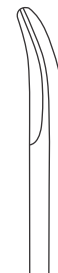

TS.06.29.22

# Suture



TS.06.30.12  
12 cm - 4¾"

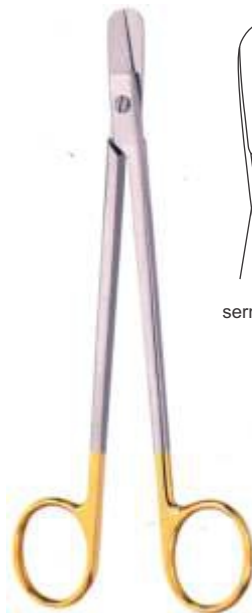

serrated blade

TS.06.30.36  
16 cm - 6¼"  
"TC"



TS.06.30.37  
16 cm - 6¼"  
"TC"



"TC"

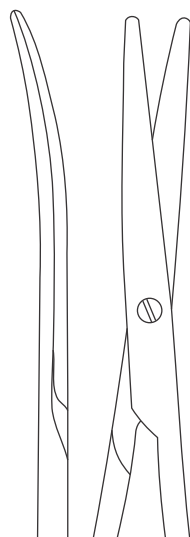

TS.06.36.84  
14.5 cm - 5¾"



TS.06.36.88  
18 cm - 7⅛"

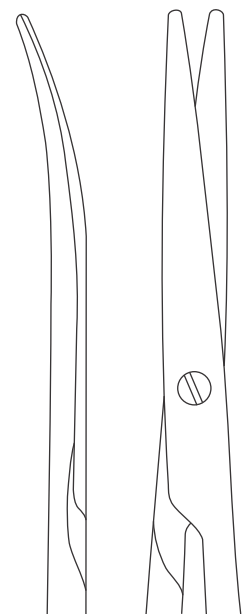

TS.06.36.93  
23 cm - 9"

Ligature scissors with micro serration and tungsten carbide edges

# Bone Files, Elevators, Raspatories





# Bone Files, Elevators, Raspatories

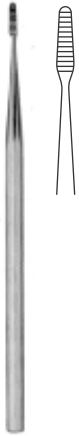

**BLACK**  
TS.06.01.11  
11 cm/ 4¼"  
TS.06.01.16  
16 cm/ 6¼"

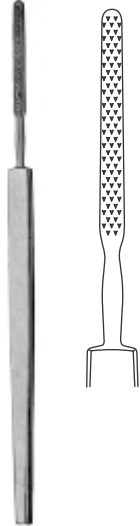

TS.06.02.13  
14 cm/ 5½"



**JOSEPH**  
17 cm/ 6¾"



TS.06.03.01  
#1

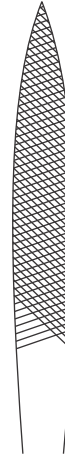

TS.06.03.02  
#2



TS.06.03.03  
#3



**PUTTI**  
TS.06.04.28  
27 cm/ 10¾"



**PUTTI**  
TS.06.05.30  
30 cm/ 11¾"



TS.06.06.22  
22 cm/ 8¾"



TS.06.07.28  
28 cm/ 11"



TS.06.08.24  
24 cm/ 9½"

# Bone Files, Elevators, Raspatories

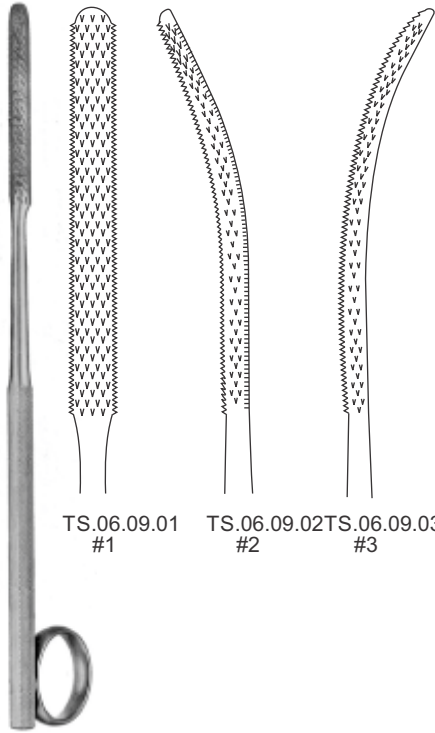

TS.06.09.01 #1  
TS.06.09.02 #2  
TS.06.09.03 #3

**GALLAHER**  
19 cm / 7½"



TS.06.10.30 #10

TS.06.10.40 #11

TS.06.10.45 #12

TS.06.10.50 #13

TS.06.10.55 #14

**MILLER**  
18 cm / 7⅞"



TS.06.10.10 #10C

TS.06.10.11 #11C

TS.06.10.12 #12C

TS.06.10.13 #13C

**MILLER**  
18 cm / 7⅞"

# Bone Files, Elevators, Raspatories

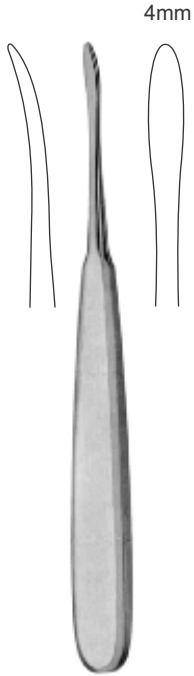

SEBILLEAU  
TS.06.11.16  
16.5 cm/ 6½"

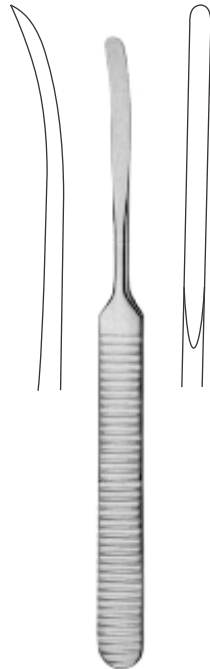

WILLIGER  
TS.06.11.17  
17 cm/ 6¾"

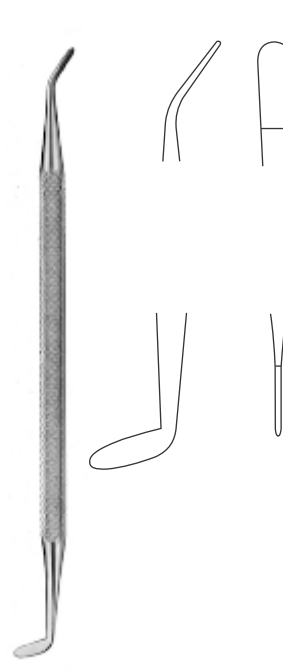

NAGATA  
TS.06.11.26  
16 cm/ 6¼"

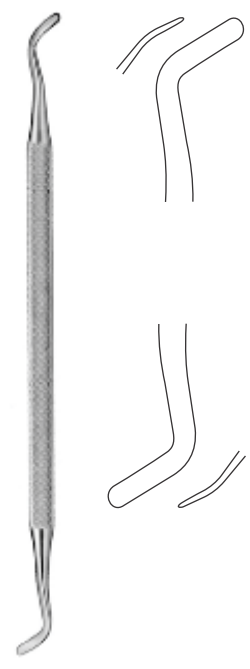

NAGATA  
TS.06.11.27  
17 cm/ 6¾"



WILLIGER  
16 cm/ 6¼"



TS.06.12.04



TS.06.12.06



TS.06.12.07



LANGENBECK

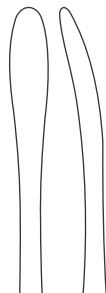

TS.06.13.01  
17 cm/ 6¾"  
5 mm

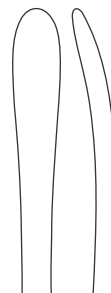

TS.06.13.02  
17 cm/ 6¾"  
7 mm



TS.06.13.03  
20 cm/ 8"  
8 mm

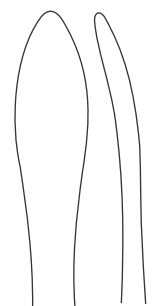

TS.06.13.04  
20 cm/ 8"  
10 mm

# Bone Files, Elevators, Raspatories



**HENAHAN**  
17 cm / 6¾"



TS.06.13.10  
10 mm



TS.06.13.12  
12 mm



TS.06.13.15  
15 mm

semi sharp



**HOEN**



TS.06.14.07  
19 cm / 7½"  
7 mm

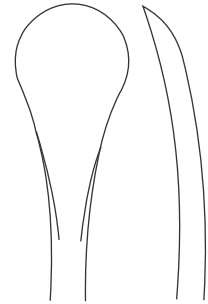

TS.06.14.15  
19 cm / 7½"  
15 mm

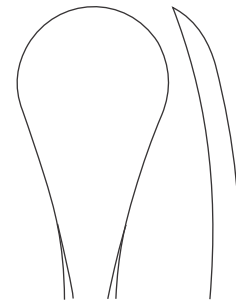

TS.06.14.20  
19 cm / 7½"  
20 mm



**WILLIGER**  
16 cm / 6¼"

4mm

5mm

7mm



TS.06.15.03 TS.06.15.05 TS.06.15.07



**FREER**  
19 cm / 7½"

5mm

5mm

6.5mm



sharp/sharp



sharp/blunt

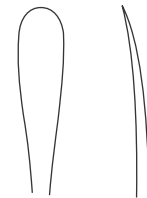

sharp/blunt



TS.06.18.01



TS.06.18.02

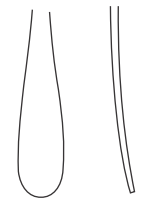

TS.06.18.03

# Bone Files, Elevators, Raspatories

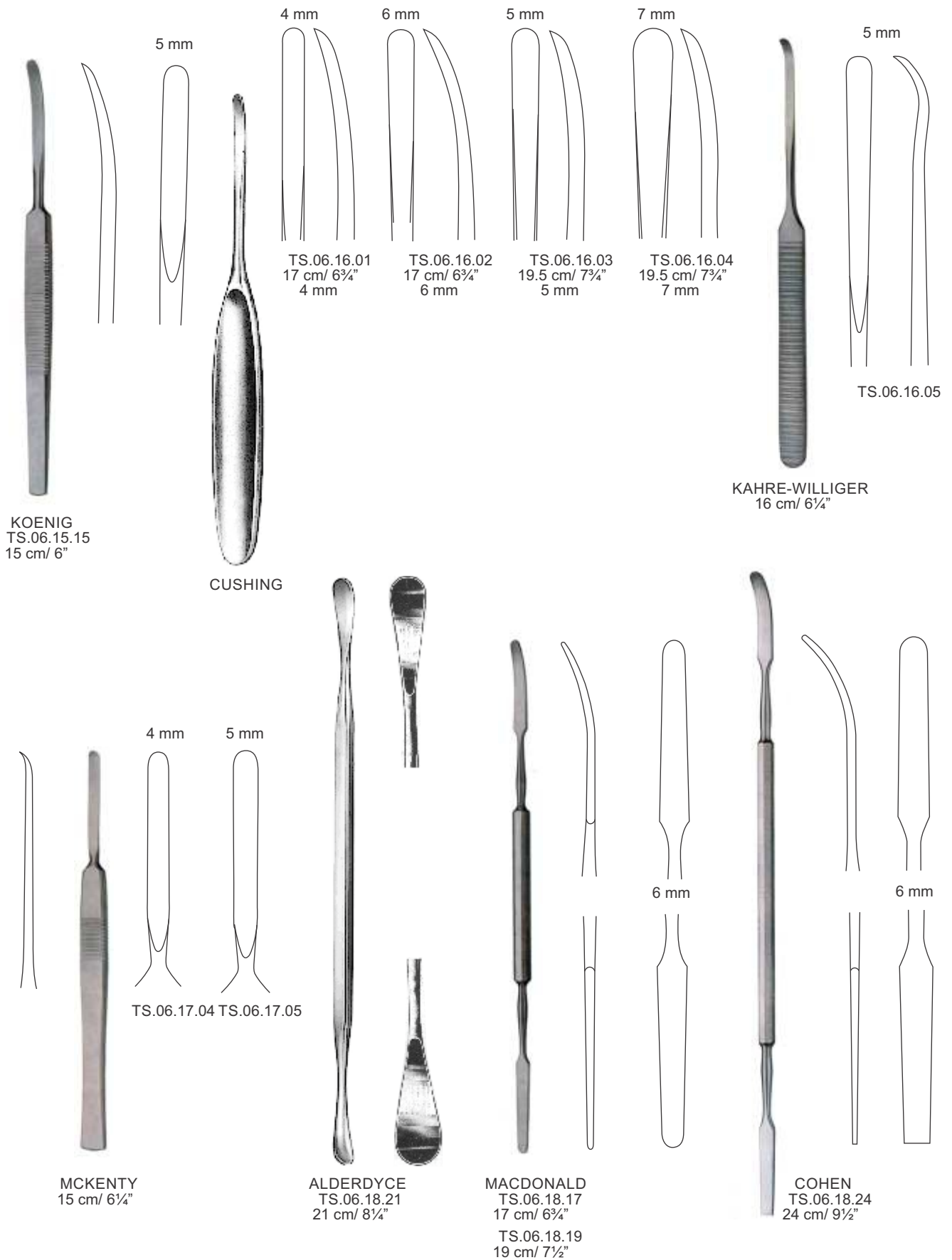

# Bone Files, Elevators, Raspatories

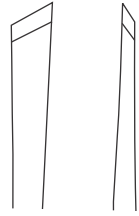

sharp/sharp



MEAD  
TS.06.19.16  
16.5 cm / 6½"

sharp/blunt

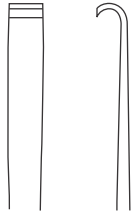

sharp/blunt

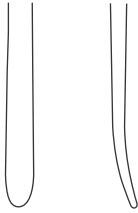

TS.06.19.18

MOLT  
18 cm / 7½"

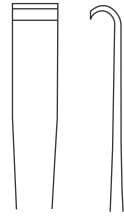

sharp/blunt

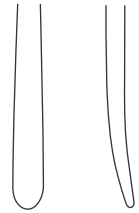

TS.06.19.19



sharp/blunt



TS.06.19.20



sharp/sharp



TS.06.19.21

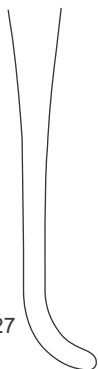
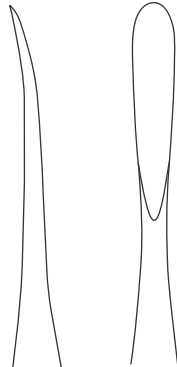

BENNET  
TS.06.18.27  
17 cm / 6¾"  
# 12S

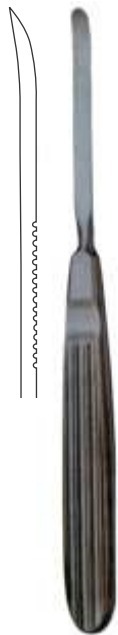

6 mm

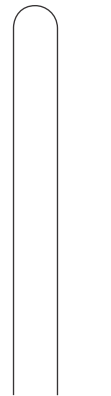

TS.06.20.06

8 mm



TS.06.20.08

17 cm / 6¾"



4 mm

WARD  
TS.06.21.19  
16.5 cm / 6½"

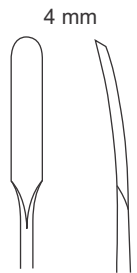

4 mm

JOSEPH  
TS.06.22.16  
16.5 cm / 6½"

# Bone Files, Elevators, Raspatories



LEMPERT  
17 cm / 6¾"

2 mm



TS.06.23.02

3 mm

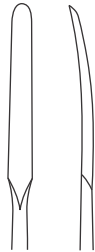

TS.06.23.03

4 mm



TS.06.23.04

5 mm



TS.06.23.05

3.5 mm

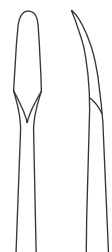

TS.06.23.06



WIBERG  
17 cm / 6¾"

4 mm



TS.06.24.01  
# 1

7 mm



TS.06.24.02  
# 2

9 mm



TS.06.24.03  
# 3

12 mm



TS.06.24.04  
# 4



KRAEMER  
TS.06.24.18  
18.5 cm / 7¼"

10 mm



KRAEMER  
TS.06.24.19  
19 cm / 7½"

10 mm

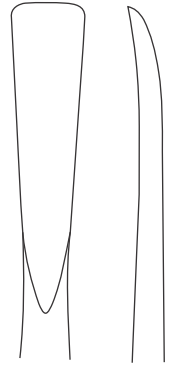

# Bone Files, Elevators, Raspatories

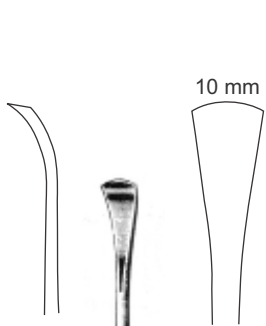

**HYLIN**  
 TS.06.25.14  
 14.5 cm/ 5¾"

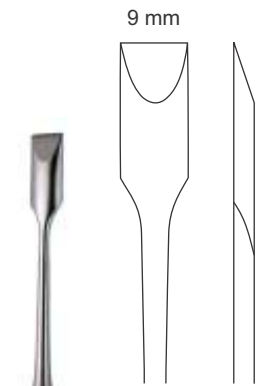

**ADSON**  
 17 cm/ 6¾"

TS.06.26.01



**SEDILLOT**  
 TS.06.28.21  
 21 cm/ 8¼"

TS.06.26.02

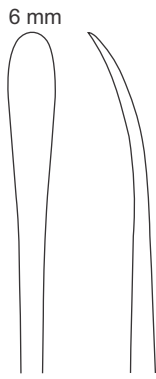

TS.06.26.03

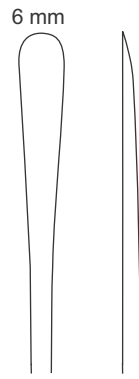

TS.06.26.04

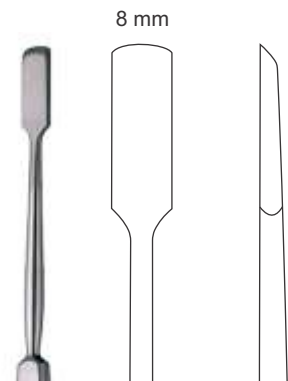

**OLIVECRONA**  
 TS.06.25.18  
 18 cm/ 7½"



**MATHIEU**  
 14 cm/ 5½"

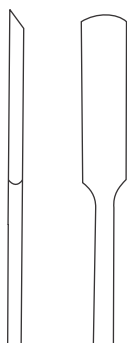

TS.06.27.06

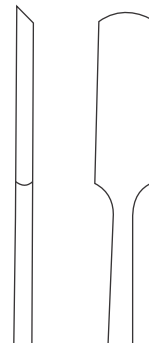

TS.06.27.09

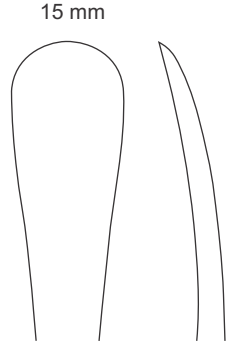

**SEDILLOT**  
 TS.06.28.19  
 19 cm/ 7½"

15 mm



# Bone Files, Elevators, Raspatories



18.5 cm / 7 1/4"

6 mm

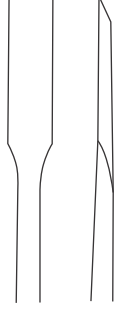

TS.06.29.18

3 mm



TS.06.29.19

6 mm



TS.06.29.20

6 mm



TS.06.29.26



20 mm

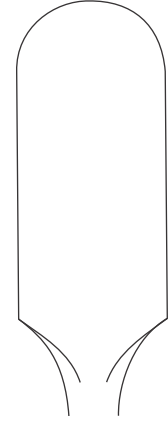

TS.06.29.50  
20 cm / 8"

5 mm

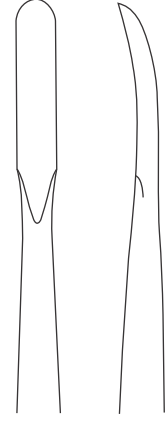

TS.06.29.46  
20 cm / 8"



TS.06.29.30  
20 cm / 8"

13 mm

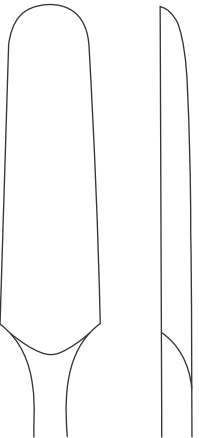

15 mm



KIRMISSION  
TS.06.30.16  
16.5 cm / 6 1/2"

12 mm



JANSEN  
TS.06.30.17  
17 cm / 6 3/4"



SCHNEIDER  
TS.06.30.19  
19 cm / 7 1/2"

# Bone Files, Elevators, Raspatories



30 cm / 11¾"

16 mm

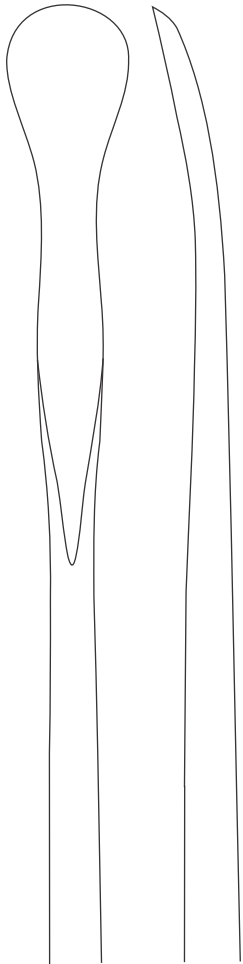

TS.06.30.36

18 mm

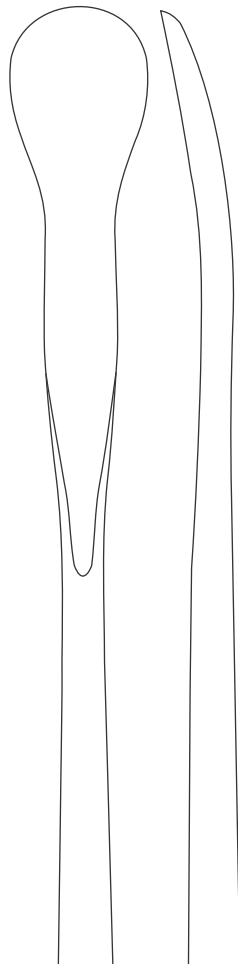

TS.06.30.38



SEMB  
 TS.06.31.01  
 20.5 cm / 8⅞"



SEMB  
 TS.06.31.02  
 24 cm / 9½"



SEMB  
 TS.06.31.03  
 24 cm / 9½"



SEMB  
 TS.06.31.04  
 22 cm / 8¾"

# Bone Files, Elevators, Raspatories



SEMB  
TS.07.31.07  
22.5 cm / 9"

12 mm

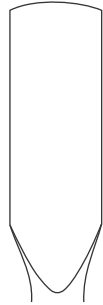

FARABEU  
15 cm / 6"



TS.07.32.15

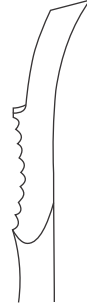

TS.07.32.16



FARABEU  
TS.07.32.19  
19 cm / 7½"



12 mm



11 mm



FARABEU-COLLIN  
16 cm / 6¼"

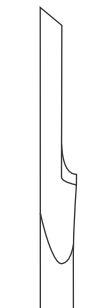

TS.07.32.46



TS.07.32.47



TS.07.33.20  
20 cm / 8"



13 mm



TS.07.33.21  
20 cm / 8"

14 mm



# Bone Files, Elevators, Raspatories



TS.07.33.22  
 20 cm / 8"

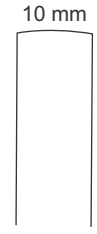

TS.07.34.10

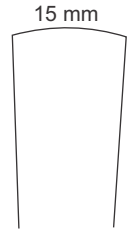

TS.07.34.15

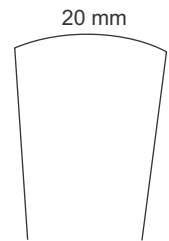

TS.07.34.20

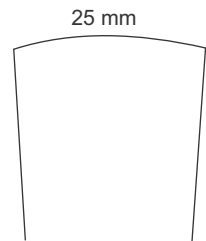

TS.07.34.25

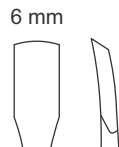

TS.07.35.06  
 18 cm / 7 1/8"

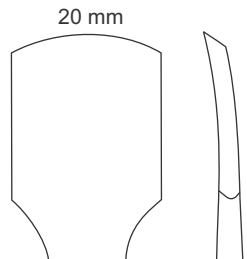

TS.07.35.20  
 20 cm / 8"

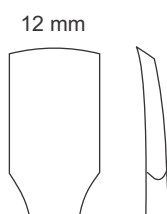

TS.07.35.12  
 19 cm / 7 1/2"

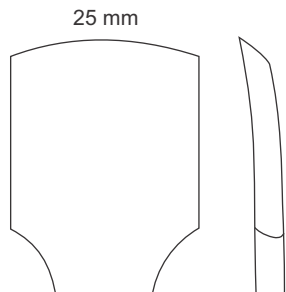

TS.07.35.25  
 21 cm / 8 1/4"

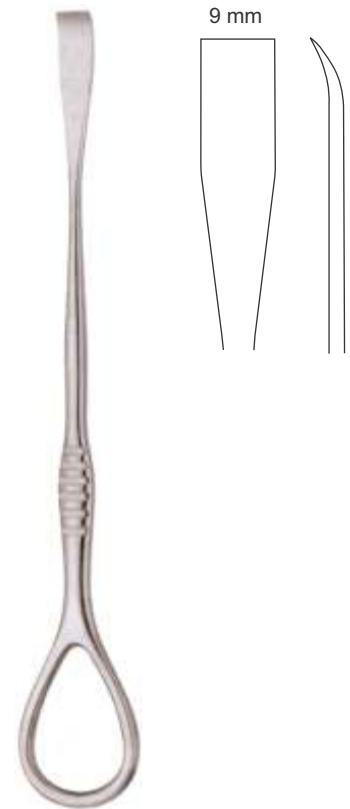

# Bone Files, Elevators, Raspatories

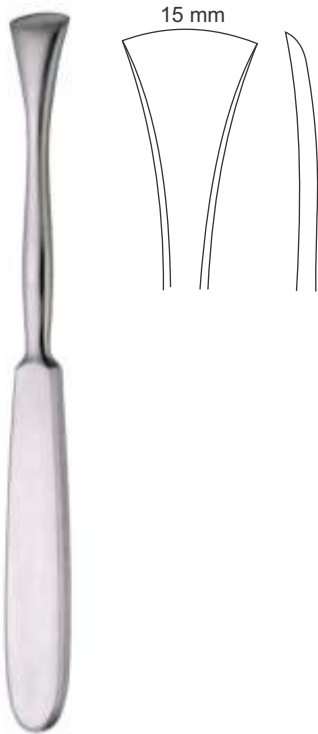

LANGENBECK  
TS.07.37.35  
19 cm / 7½"

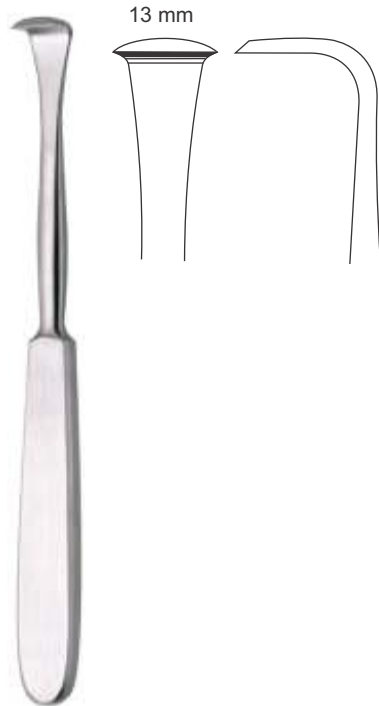

LANGENBECK  
TS.07.37.63  
18 cm / 7⅝"



CUSHING  
18 cm / 7⅝"

TS.07.38.01

TS.07.38.02



WANG  
TS.07.38.18  
18 cm / 7¼"



WANG  
TS.07.38.19  
18 cm / 7¼"

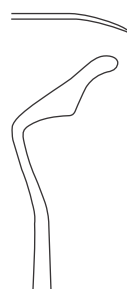

WANG  
TS.07.38.28  
18 cm / 7¼"

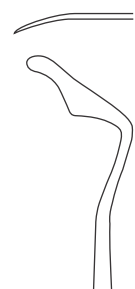

WANG  
TS.07.38.29  
18 cm / 7¼"

# Bone Files, Elevators, Raspatories



28 cm/ 11"

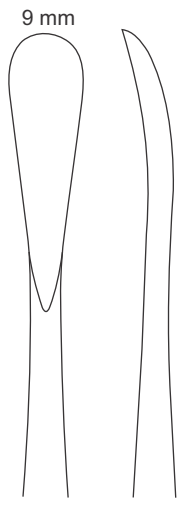

9 mm

TS.07.40.01

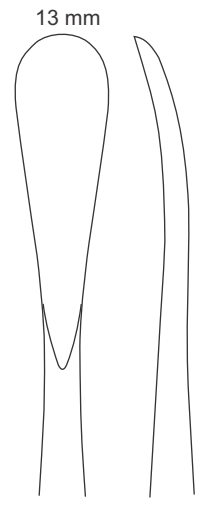

13 mm

TS.07.40.02

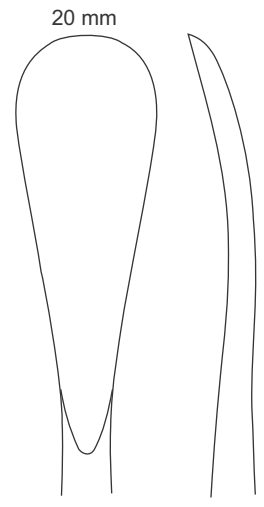

20 mm

TS.07.40.03



29 cm/ 11<sup>3</sup>/<sub>8</sub>"

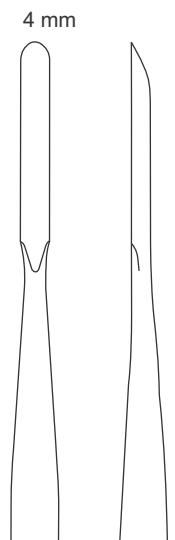

4 mm

TS.07.40.04

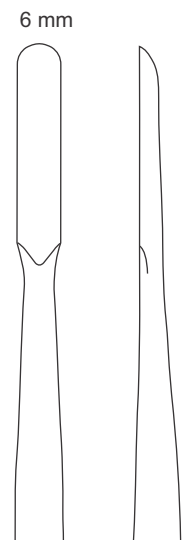

6 mm

TS.07.40.06

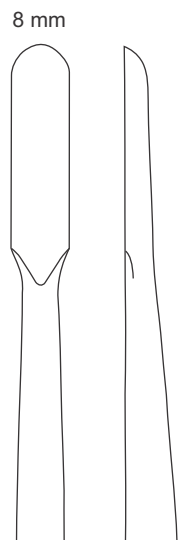

8 mm

TS.07.40.08

# Bone Files, Elevators, Raspatories



COBB  
25 cm / 10"

10 mm



TS.07.40.10

13 mm

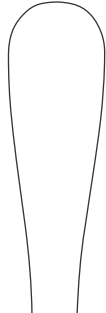

TS.07.40.13

19 mm

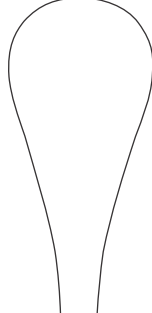

TS.07.40.19

25 mm

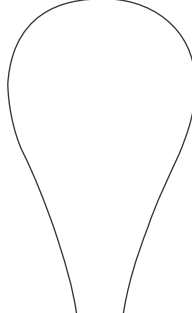

TS.07.40.25

4 mm



TS.07.41.04

5 mm



TS.07.41.05

6 mm



TS.07.41.06



30 cm / 11 $\frac{3}{4}$ "



TS.07.41.28  
28 cm / 11"

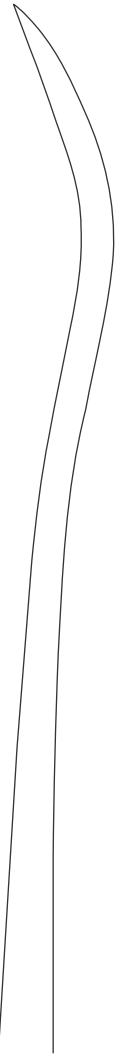
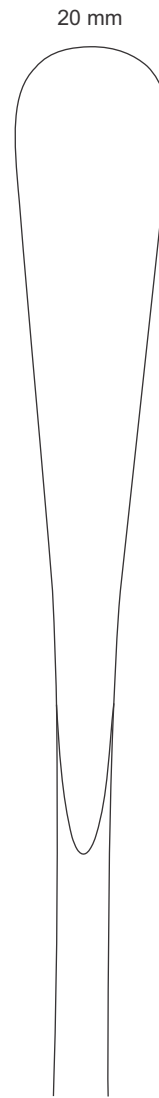

FREER  
TS.07.42.18  
18 cm / 7 $\frac{1}{8}$ "

# Bone Files, Elevators, Raspatories



WAGNER  
33 cm/13"

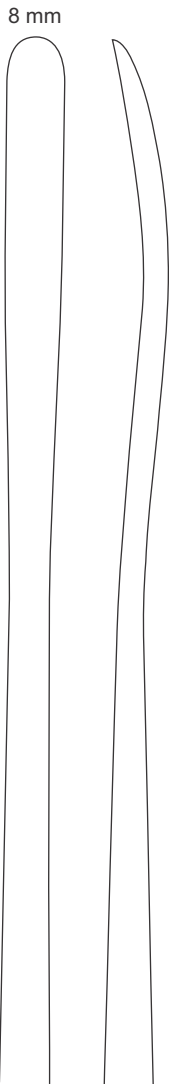

8 mm

TS.07.42.33

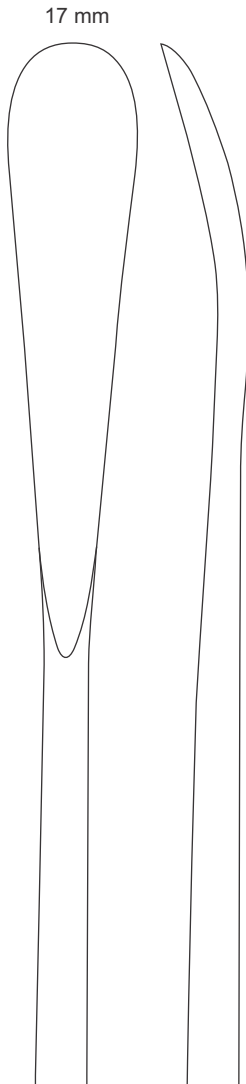

17 mm

TS.07.42.34



LANGENBECK  
20 cm/ 8"



8 mm

TS.07.46.08

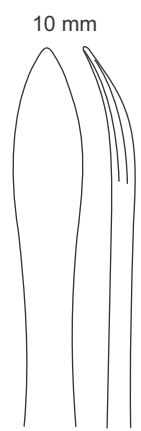

10 mm

TS.07.46.10

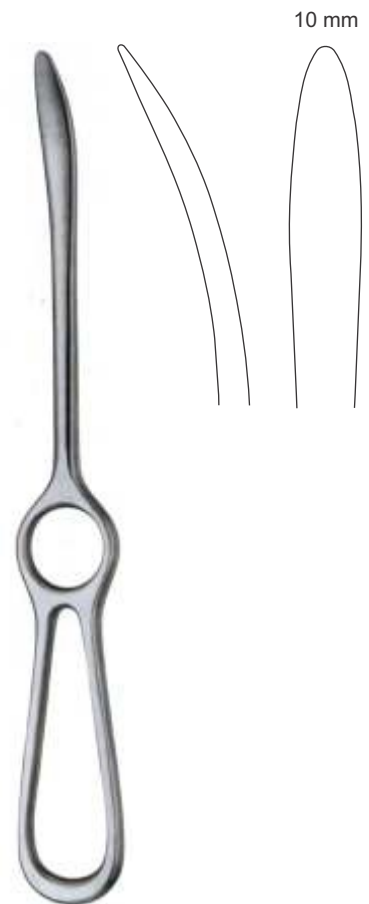

LANGENBECK  
TS.07.47.11  
23 cm/ 9"

10 mm



# Bone Files, Elevators, Raspatories

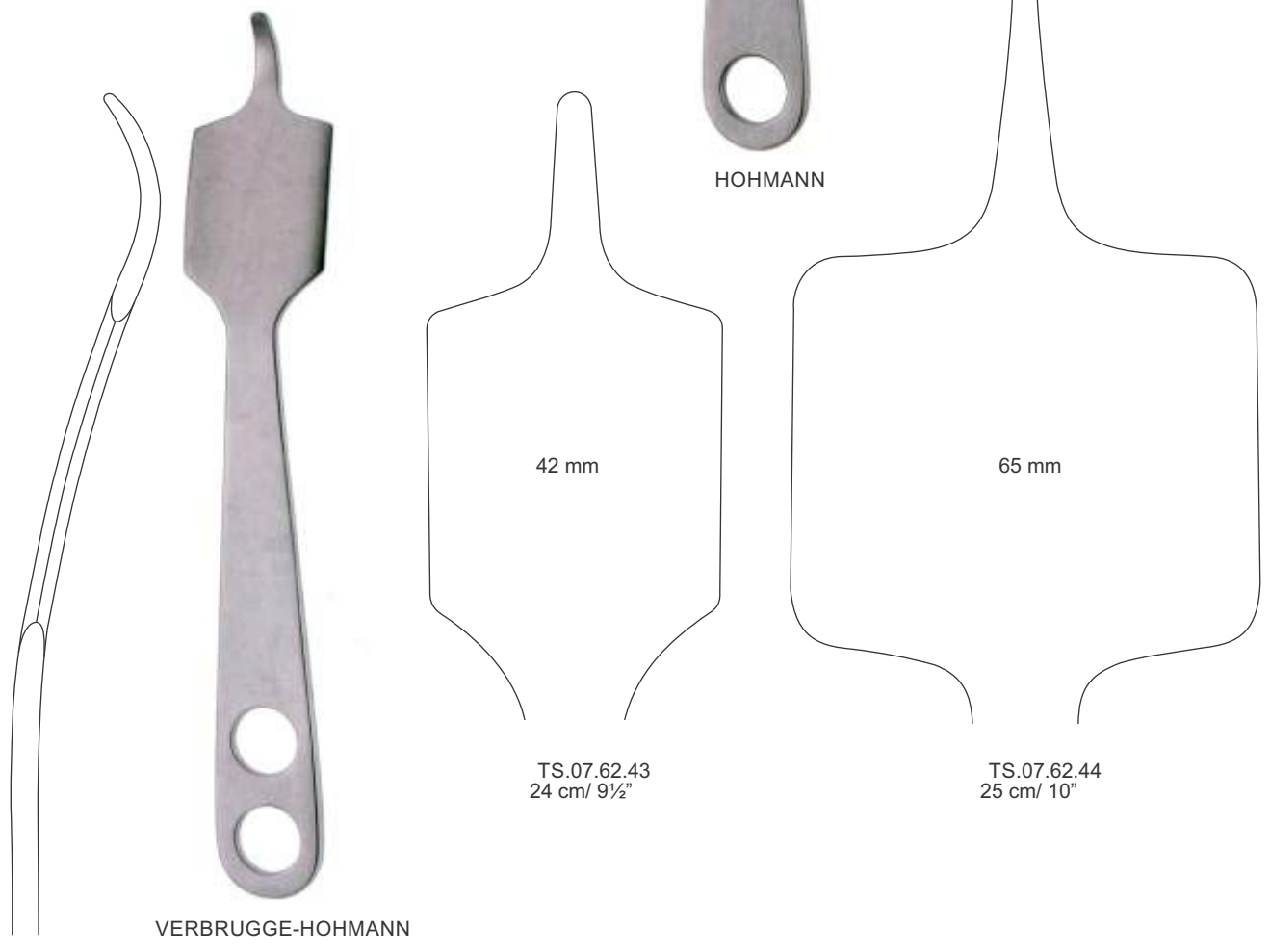
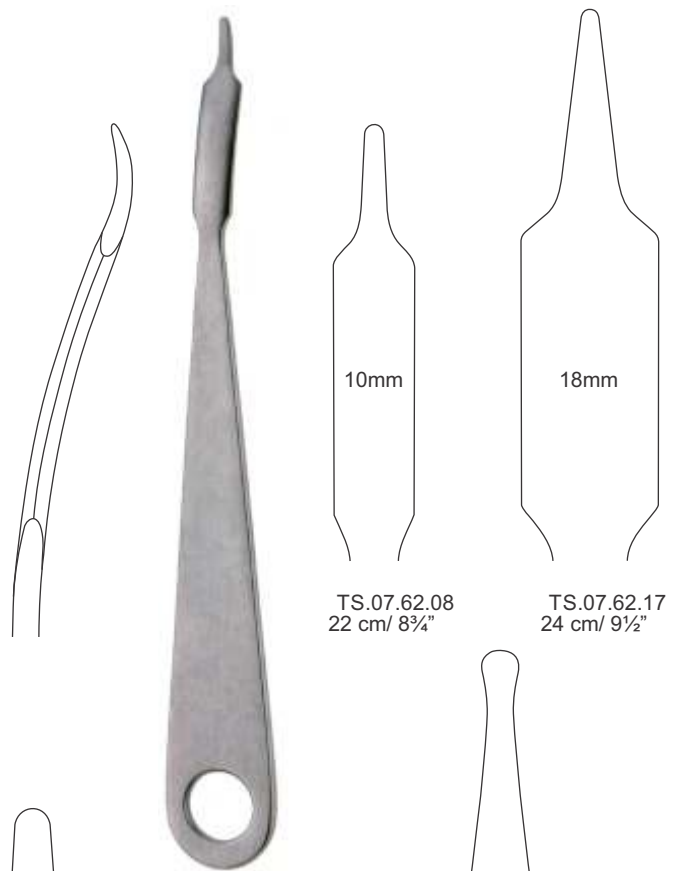

# Bone Files, Elevators, Raspatories

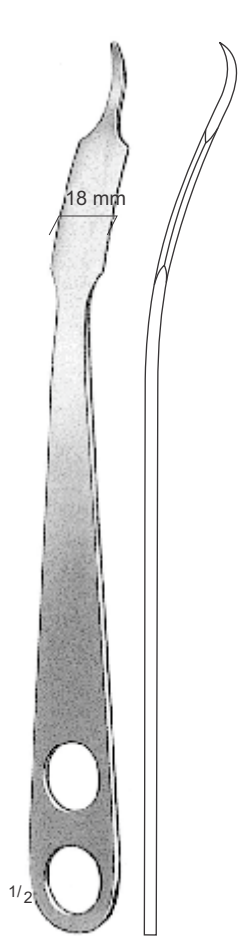

TS.07.62.18  
24 cm / 9½"

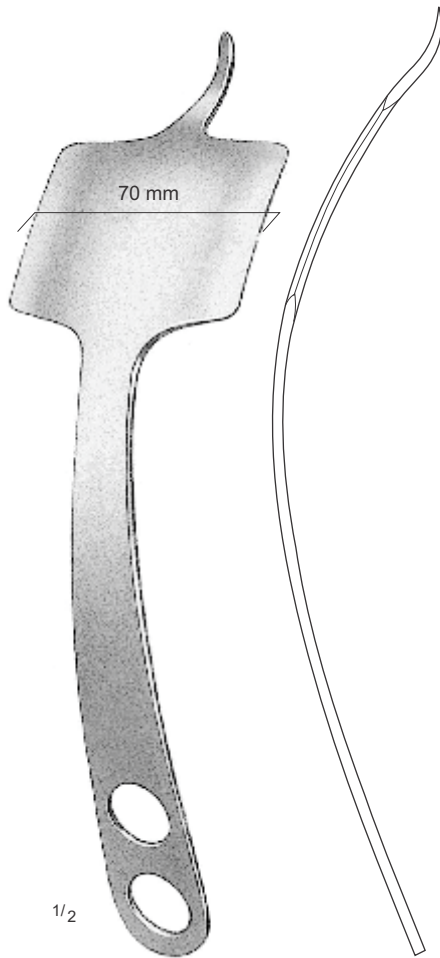

TS.07.62.70  
29 cm / 11½"

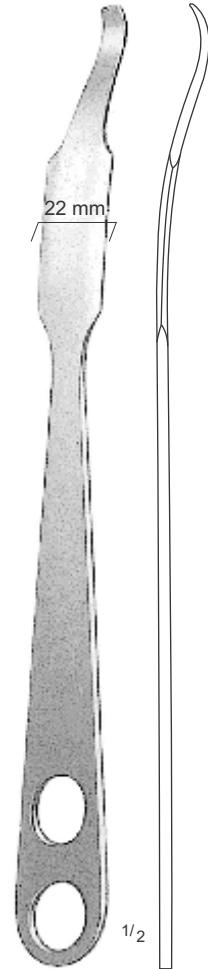

TS.07.64.22  
25 cm / 10"

# Bone Files, Elevators, Raspatories

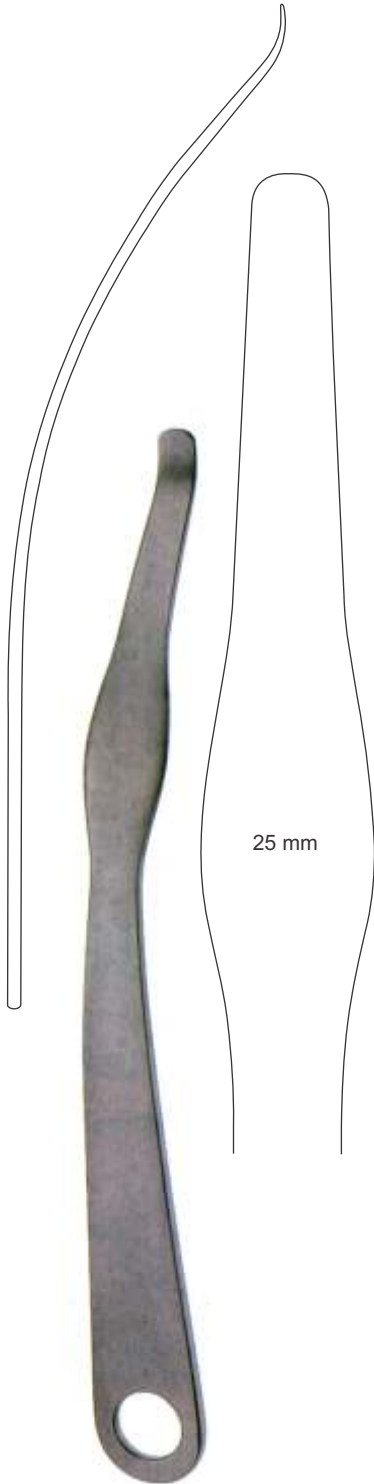

TS.07.64.24  
27 cm / 10<sup>3</sup>/<sub>4</sub>"

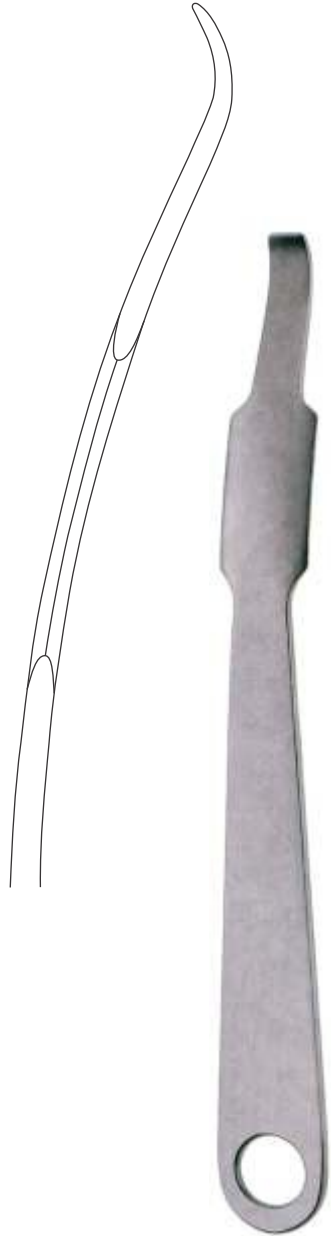

HOHMANN

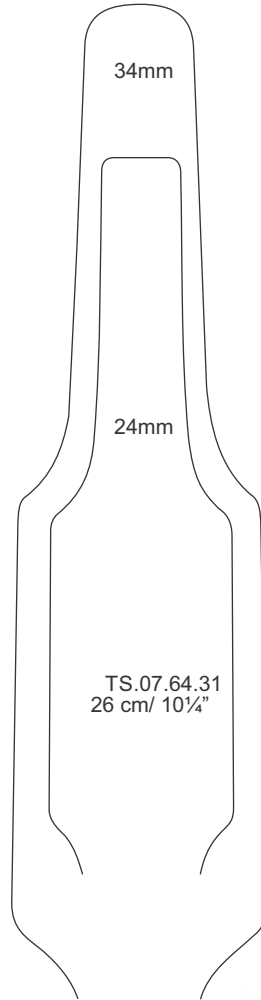

TS.07.64.31  
26 cm / 10<sup>1</sup>/<sub>4</sub>"

TS.07.64.3  
29 cm / 11<sup>1</sup>/<sub>2</sub>"

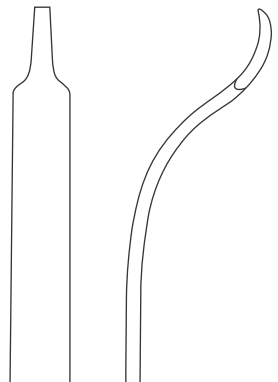

BUCK-GRAMCKO  
TS.07.66.15  
15 cm / 6"

# Bone Files, Elevators, Raspatories

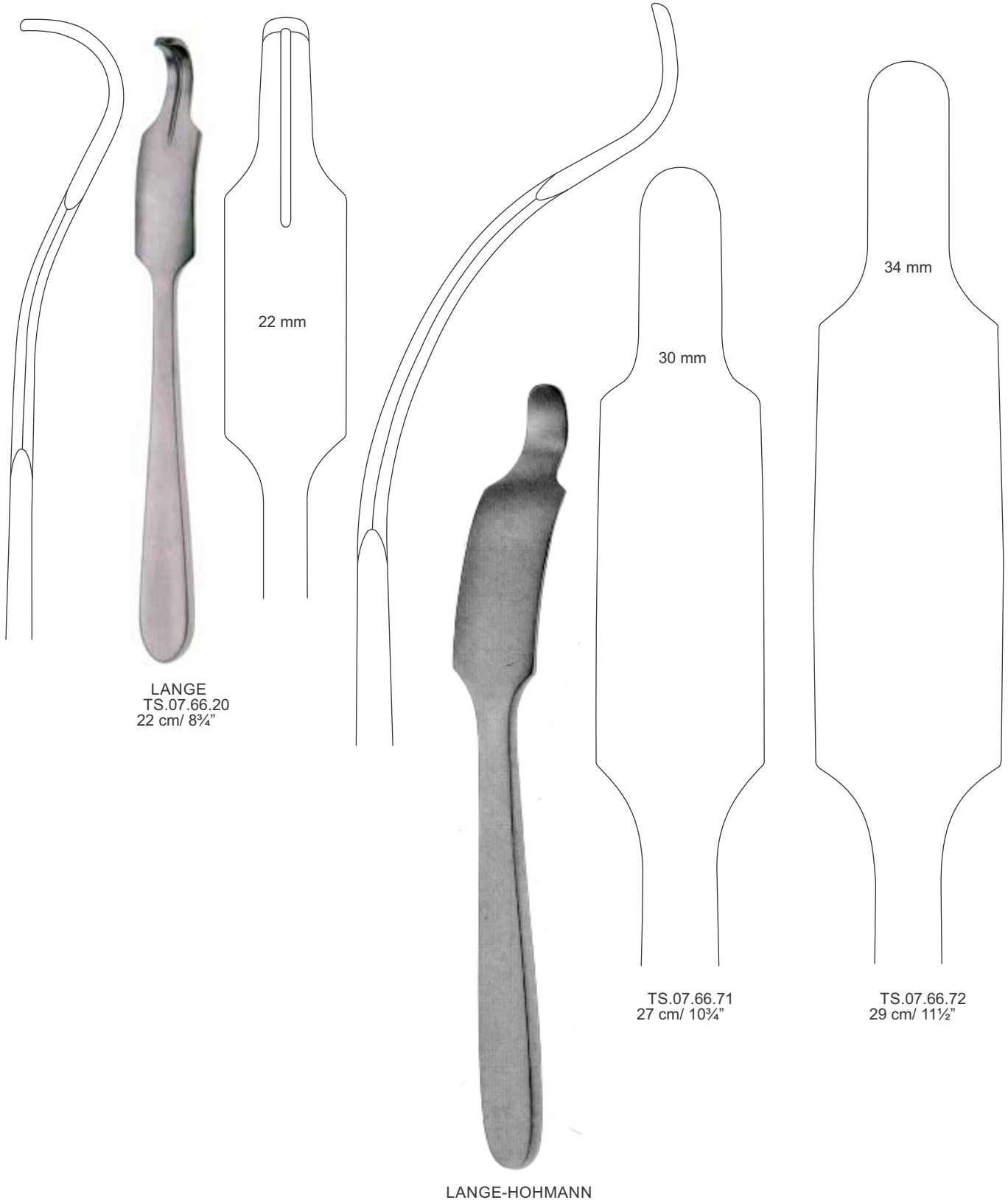

LANGE  
TS.07.66.20  
22 cm / 8<sup>3</sup>/<sub>4</sub>"

22 mm

30 mm

34 mm

TS.07.66.71  
27 cm / 10<sup>3</sup>/<sub>4</sub>"

TS.07.66.72  
29 cm / 11<sup>1</sup>/<sub>2</sub>"

LANGE-HOHMANN

# Bone Files, Elevators, Raspatories

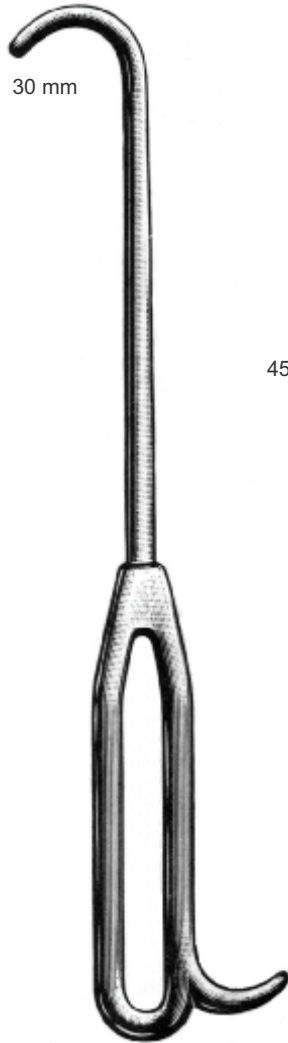

LAMBOTTE  
TS.07.68.27  
27 cm/ 10¾"



BENNET  
TS.07.74.34  
24 cm/ 9½"



BENNET  
TS.07.74.25  
24 cm/ 9½"



BENNET  
TS.07.74.44  
24 cm/ 9½"

# Bone Files, Elevators, Raspatories

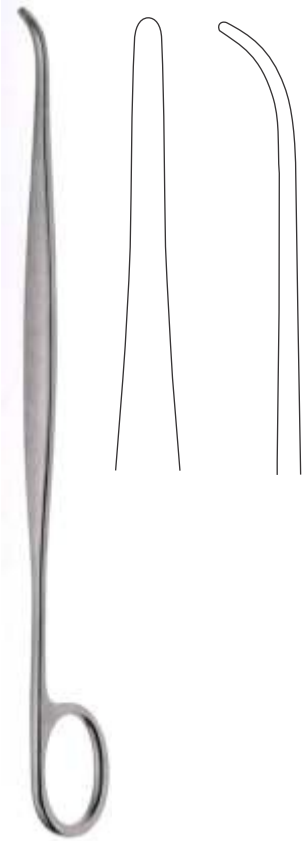

LANE  
TS.07.70.21  
21 cm / 8¼"

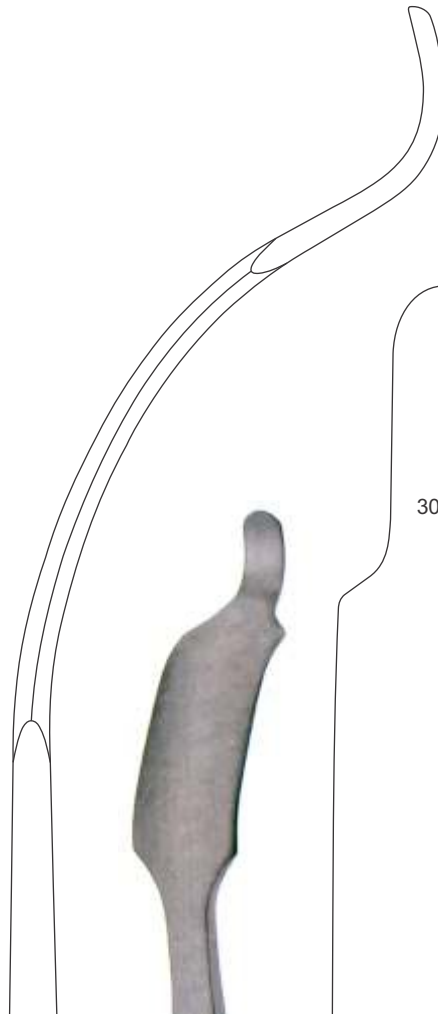

LANGE-HOHMANN  
MODIF.

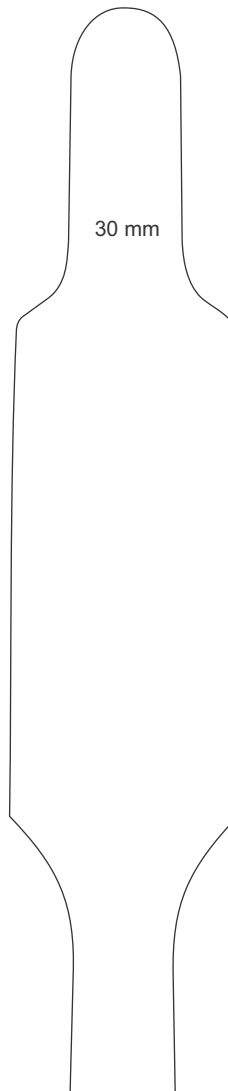

TS.07.71.27  
27 cm / 10¾"

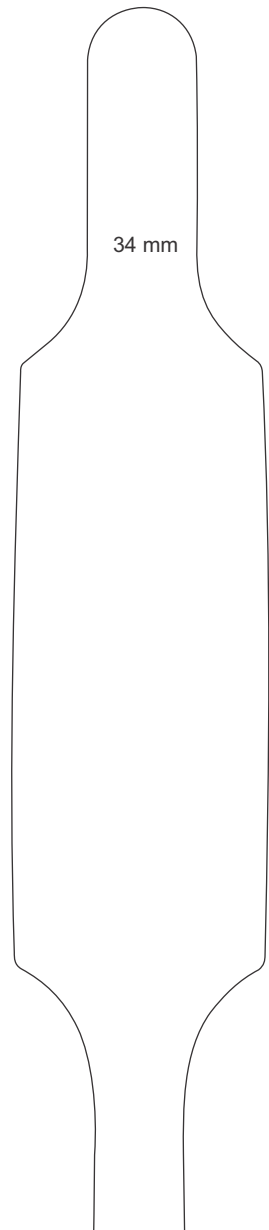

TS.07.71.29  
29 cm / 11½"

# Bone Files, Elevators, Raspatories

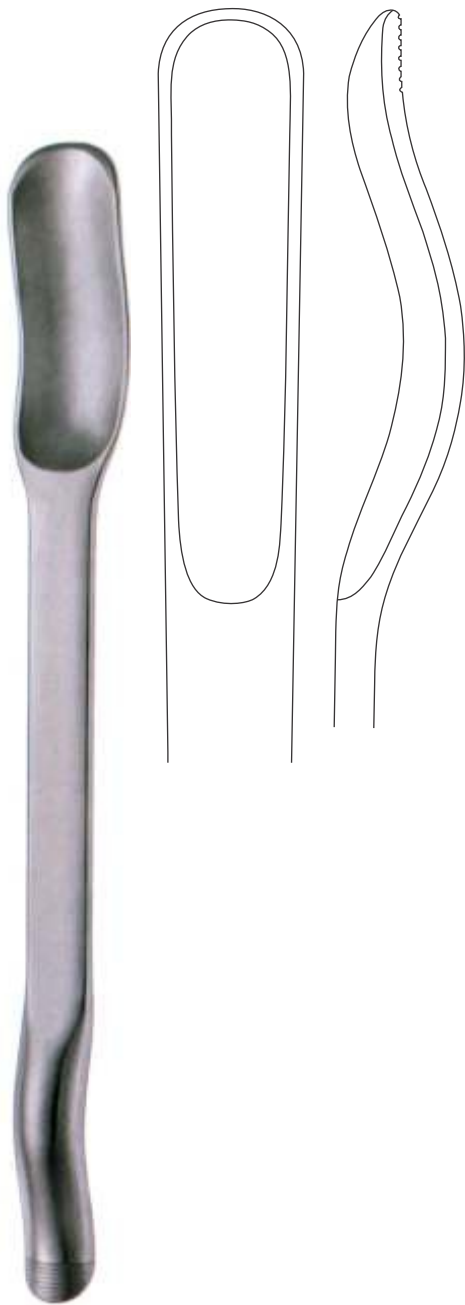

MURPHY-LANE  
TS.07.73.31  
31 cm/ 12 $\frac{1}{8}$ "

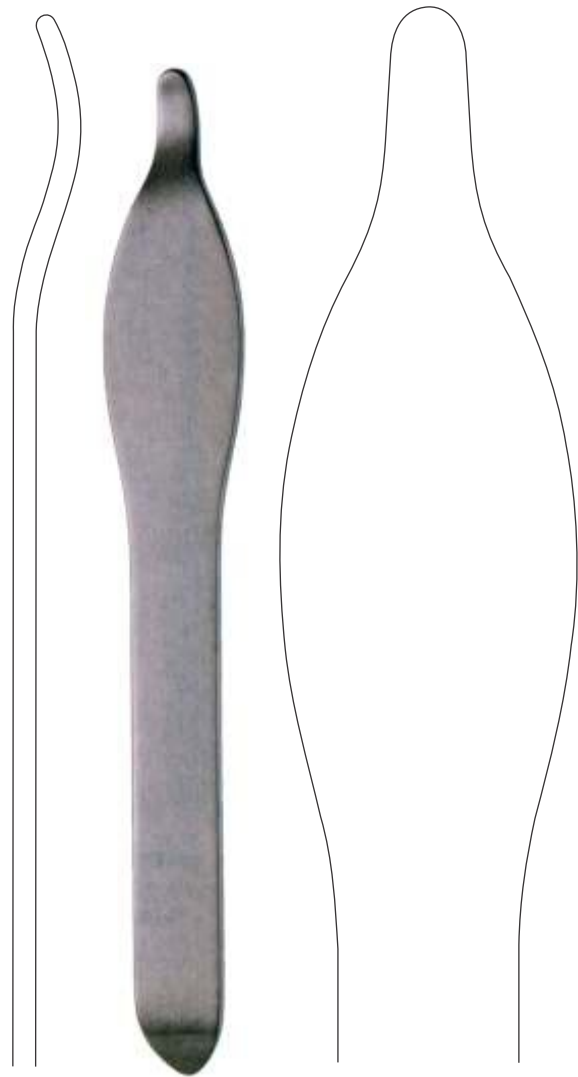

BLOUNT  
TS.07.75.27  
27 cm/ 10 $\frac{3}{4}$ "

# Bone Files, Elevators, Raspatories

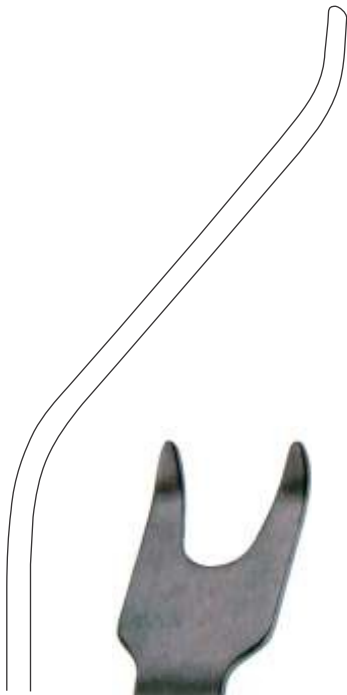

BLOUNT  
TS.07.75.52  
25 cm / 10"

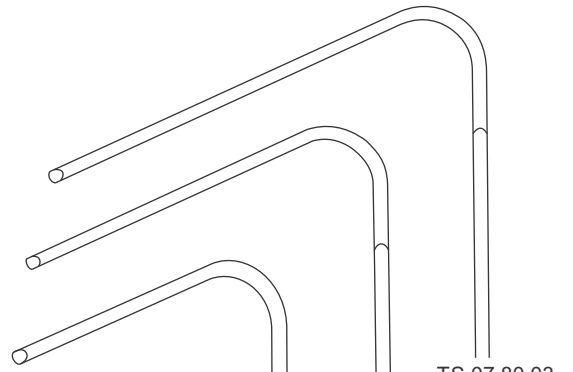
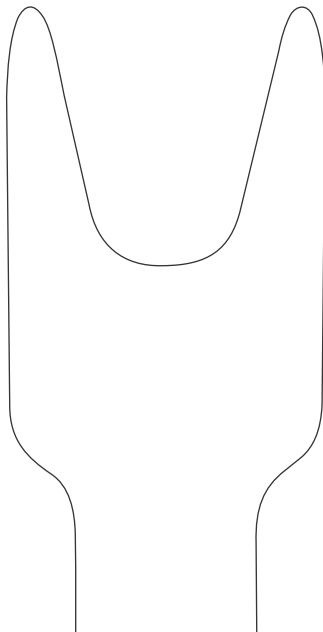

TS.07.80.03

TS.07.80.02

TS.07.80.01



SMILLIE  
14 cm / 5½"  
TS.07.80.01 # 1 - 19 x 32 mm  
TS.07.80.02 # 2 - 19 x 45 mm  
TS.07.80.03 # 3 - 19 x 60 mm



# Bone Files, Elevators, Raspatories

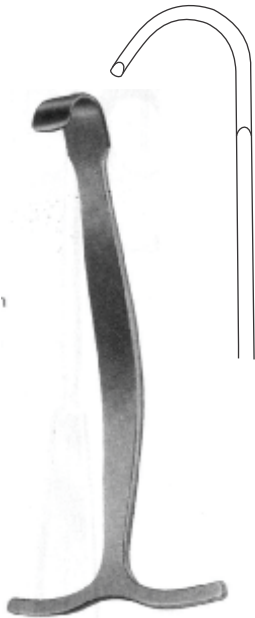

SMILLIE  
TS.07.80.04  
14 cm/ 5½"  
# 4 - 13 x 15 mm



SMILLIE  
TS.07.80.05  
14 cm/ 5½"  
# 6 - 13 x 55 mm

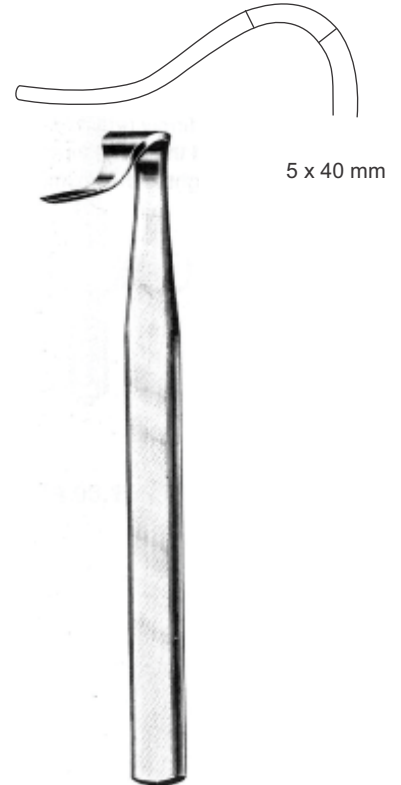

BLOUNT  
TS.07.82.18  
18 cm/ 7⅞"

5 x 40 mm



SMILLIE  
TS.07.80.06  
14 cm/ 5½"  
# 5 - 13 x 25 mm



BLOUNT  
24 cm/ 9½"

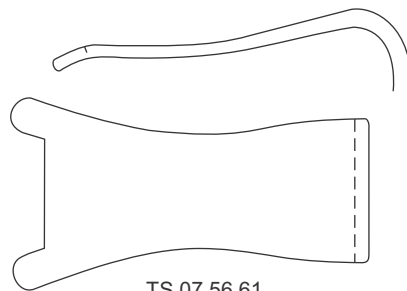

TS.07.56.61  
26 x 43 mm

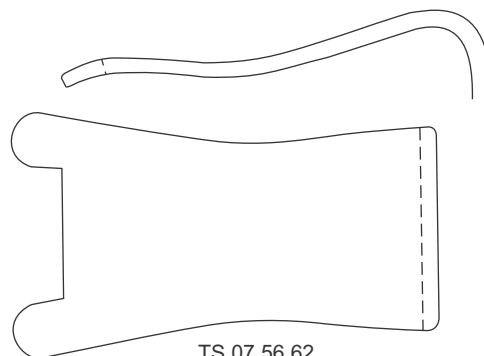

TS.07.56.62  
33 x 54 mm



Orthopedic Instruments

# Orthopedic Instruments



TS.07.01.15  
No. 18, 15 cm / 6"



TS.07.02.16  
16 cm / 6 1/4"



TS.07.03.23  
23 cm / 9"

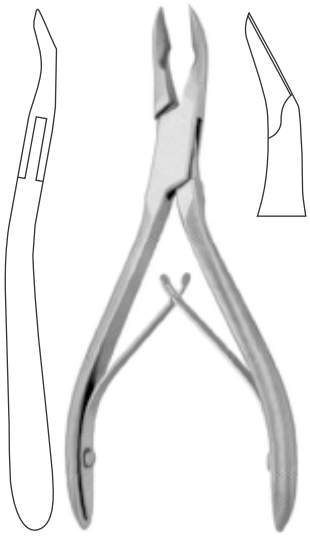
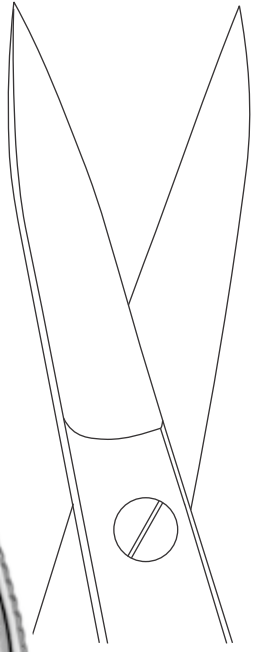

NIRO  
TS.07.04.14  
14 cm / 5 1/2"



CLEVELAND  
TS.07.05.15  
15 cm / 6"

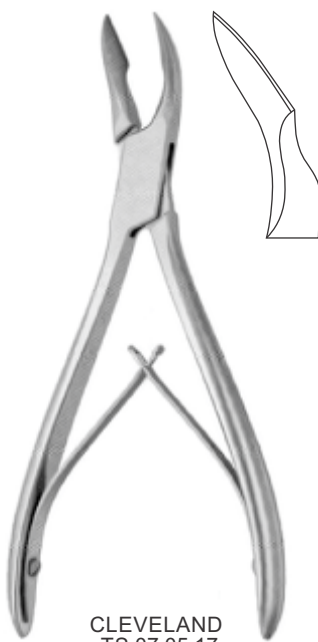

CLEVELAND  
TS.07.05.17  
17 cm / 6 3/4"



LITTAUER  
TS.07.06.15  
15 cm / 6"



**COTTLE-KAZANJIAN**  
 TS.07.07.18  
 18 cm / 7 1/8"



**COTTLE**  
 TS.07.08.18  
 18 cm / 7 1/8"



**HORSLEY**  
 TS.07.09.19  
 19 cm / 7 1/2"



**MEGA CUT®**  
 TS.07.100.47  
 47 cm / 17 3/4"  
 For cutting off  
 Kirschner wires,  
 Tibia head screws,  
 bolts, pins upto  
 6.0 mm ø



TS.07.10.14  
 14 cm / 5 1/2"



TS.07.10.17  
 17 cm / 6 3/4"



**LISTON**

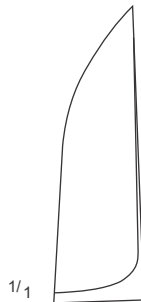

TS.07.10.19  
 19 cm / 7 1/2"



TS.07.10.22  
 22 cm / 8 3/4"

# Orthopedic Instruments

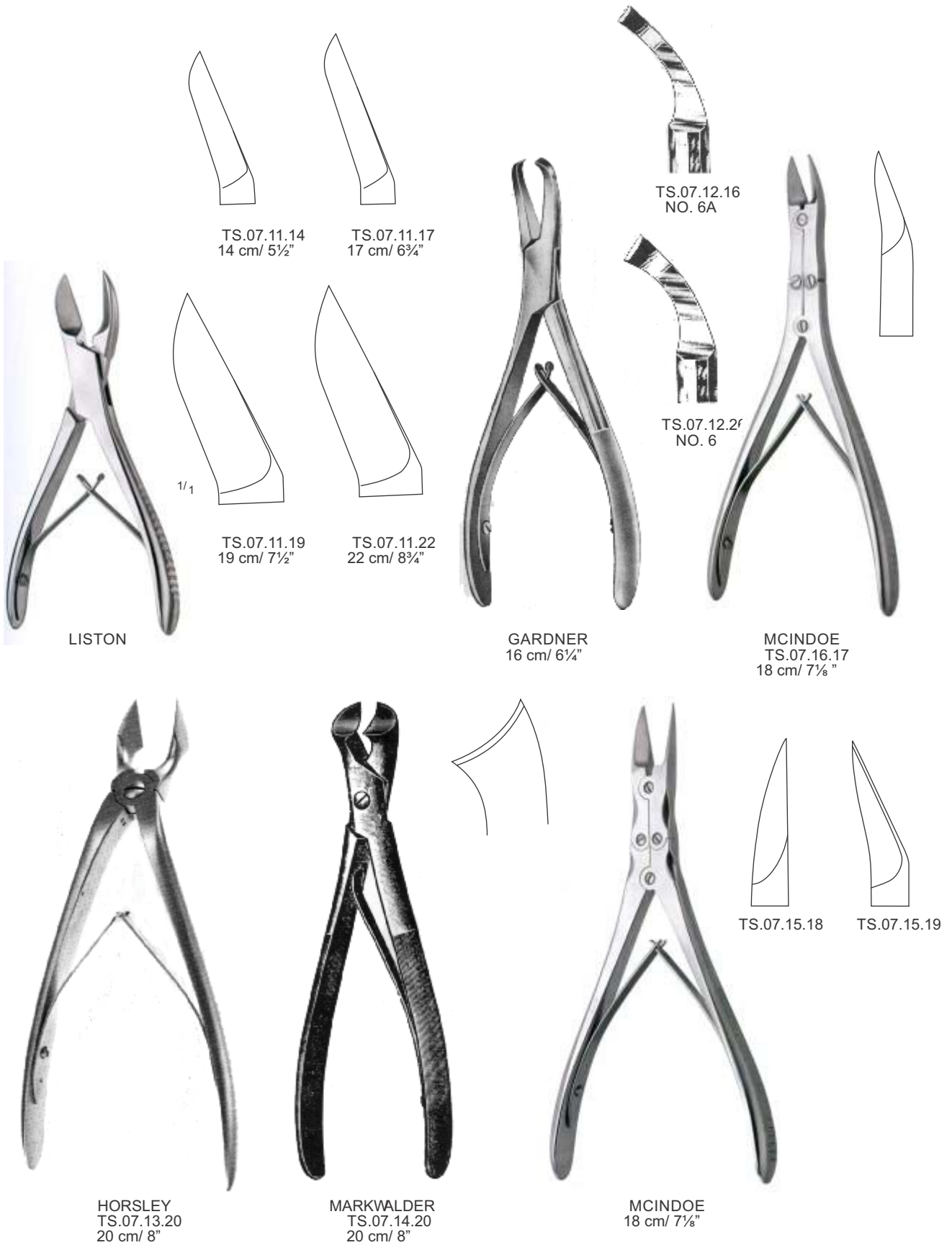

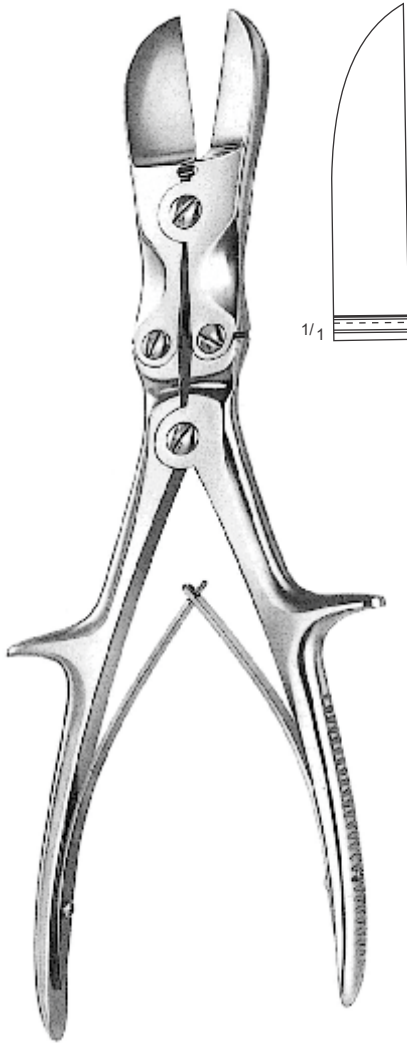

STILLE-LISTON  
 TS.07.17.27  
 27 cm / 10<sup>3</sup>/<sub>4</sub>"

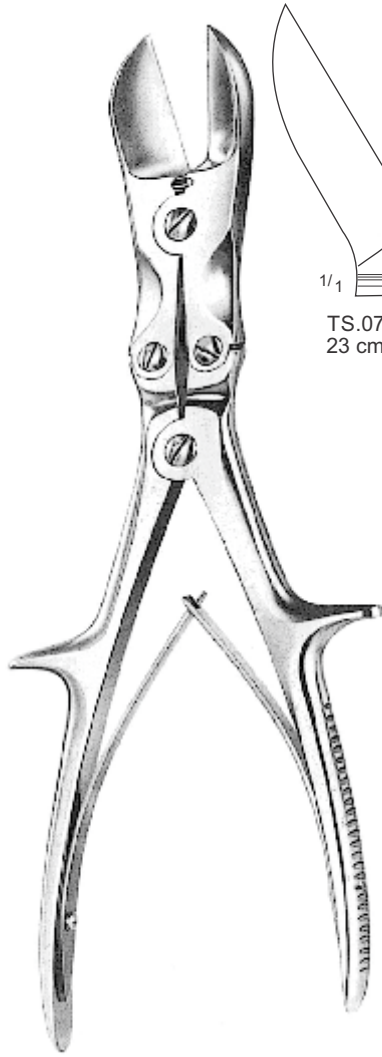

STILLE-LISTON

TS.07.18.23  
 23 cm / 9"

TS.07.18.27  
 27 cm / 10<sup>3</sup>/<sub>4</sub>"



STILLE-LISTON  
 TS.07.19.27  
 27 cm / 10<sup>3</sup>/<sub>4</sub>"

# Orthopedic Instruments

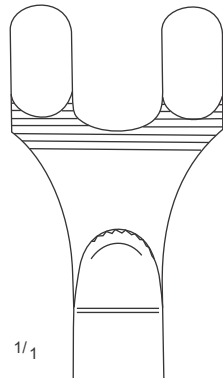
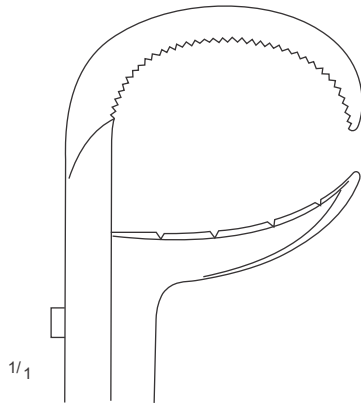

TS.07.35.18  
18 cm / 7 1/4"

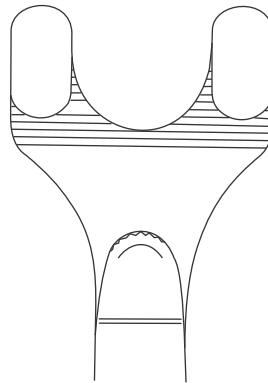

TS.07.35.20  
20 cm / 8"

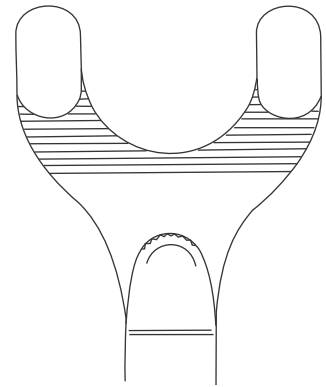

TS.07.35.22  
22 cm / 8 3/4"

GERSTER-LOWMAN

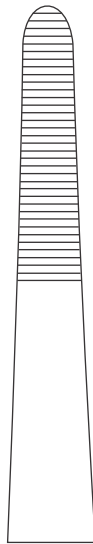

VAN BUREN  
TS.07.35.23  
23 cm / 9"



TS.07.36.20  
19 cm / 7 1/2"

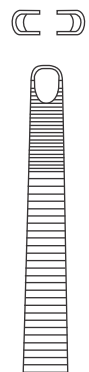

DINGMAN  
TS.07.38.19  
19 cm / 7 1/2"

# Orthopedic Instruments



DINGMAN  
 TS.07.39.19  
 19 cm / 7½"



TS.07.40.21  
 21 cm / 8¼"

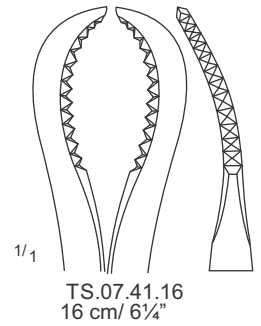

TS.07.41.16  
 16 cm / 6¼"

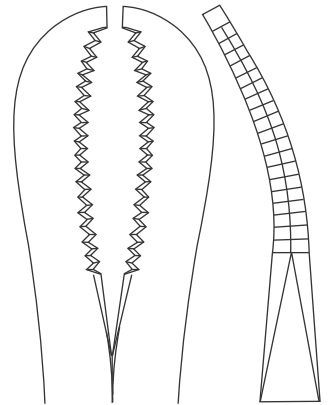

TS.07.42.22  
 22 cm / 8¾"

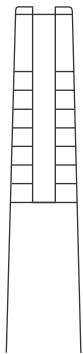

SEMB  
 TS.07.43.20  
 20 cm / 8"



OBWEGESER  
 TS.07.43.45  
 15.5 cm / 6⅛"

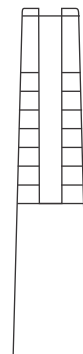

SEMB  
 TS.07.44.20  
 20 cm / 8"



# Orthopedic Instruments

straight

Angled on Flat

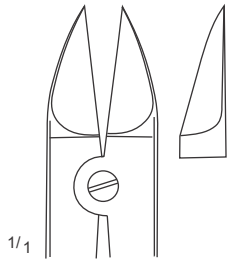

TS.07.20.15



**LISTON-MINI**  
15 cm / 6"

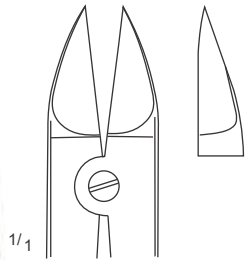

TS.07.21.15



**KLEINERT-KUTZ**  
TS.07.22.15  
15 cm / 6"



TS.07.23.18



**RUSKIN-ROWLAND**  
18 cm / 7 1/8"

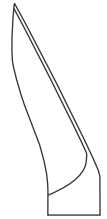

TS.07.24.18



**RUSKIN-LISTON**  
18 cm / 7 1/8"



TS.07.25.18



TS.07.26.18



**LISTON-KEY HORSLEY**  
TS.07.28.25  
25.5 cm / 10"

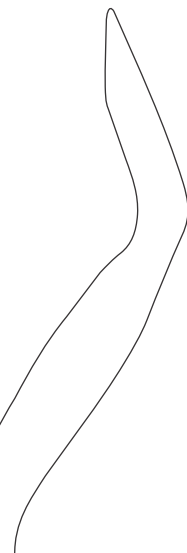

# Orthopedic Instruments



**LISTON-KEY**  
 TS.07.28.27  
 26 cm / 10¼"

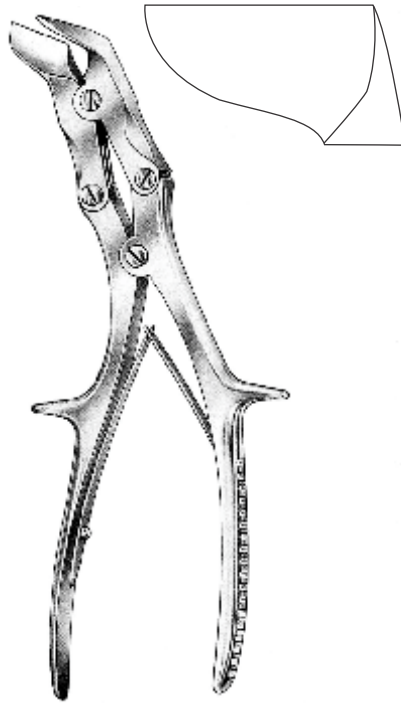

**SEMB**  
 TS.07.29.23  
 23 cm / 9"

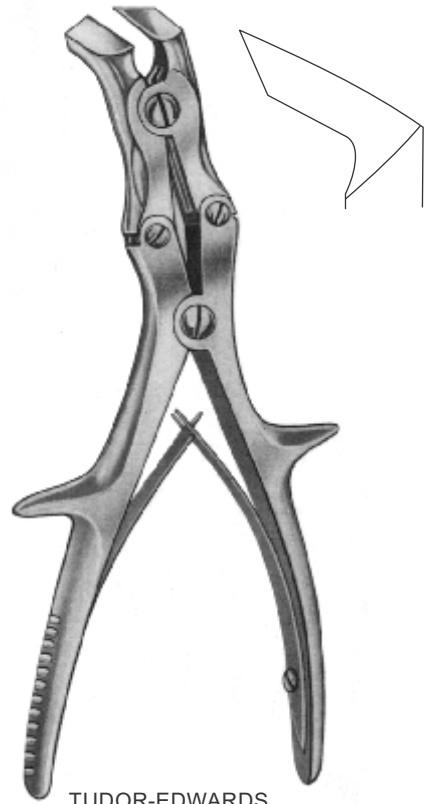

**TUDOR-EDWARDS**  
 TS.07.30.23  
 23 cm / 9"



TS.07.31.13  
 13.5 cm / 5¼"



**STEINHAUSER**  
 TS.07.32.13  
 13 cm / 5½"



20 cm / 8"

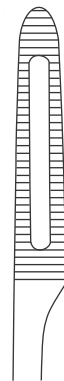

TS.07.33.20

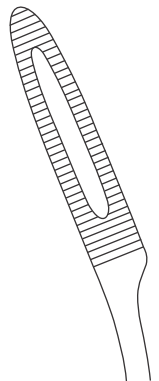

TS.07.34.20

Sequestrum forceps

# Orthopedic Instruments



ROWE-HARRISON  
TS.07.45.20  
20 cm / 8"



TS.07.46.14  
14 cm / 5½"

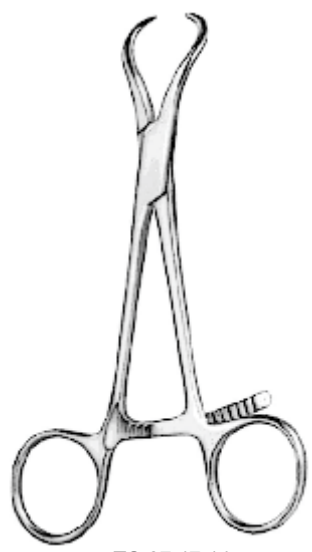

TS.07.47.14  
14 cm / 5½"



TS.07.47.15  
13.5 cm / 5¼"

Wire Twisting Forceps

extra large opening for hand surgery

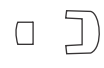

KISTLER-MANUS  
TS.07.47.16  
15.5 cm / 6½"

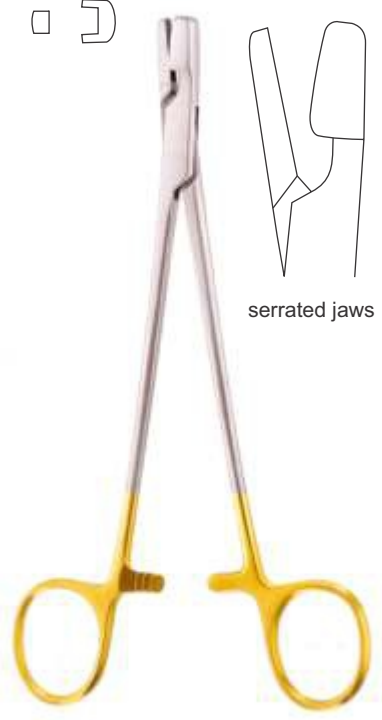

"TC"  
TS.07.48.01  
17 cm / 6¾"

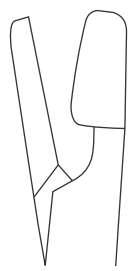

serrated jaws



CORWIN-HEGAR "TC"  
TS.07.48.03  
16 cm / 6¼"



Cartilage and meniscus forceps

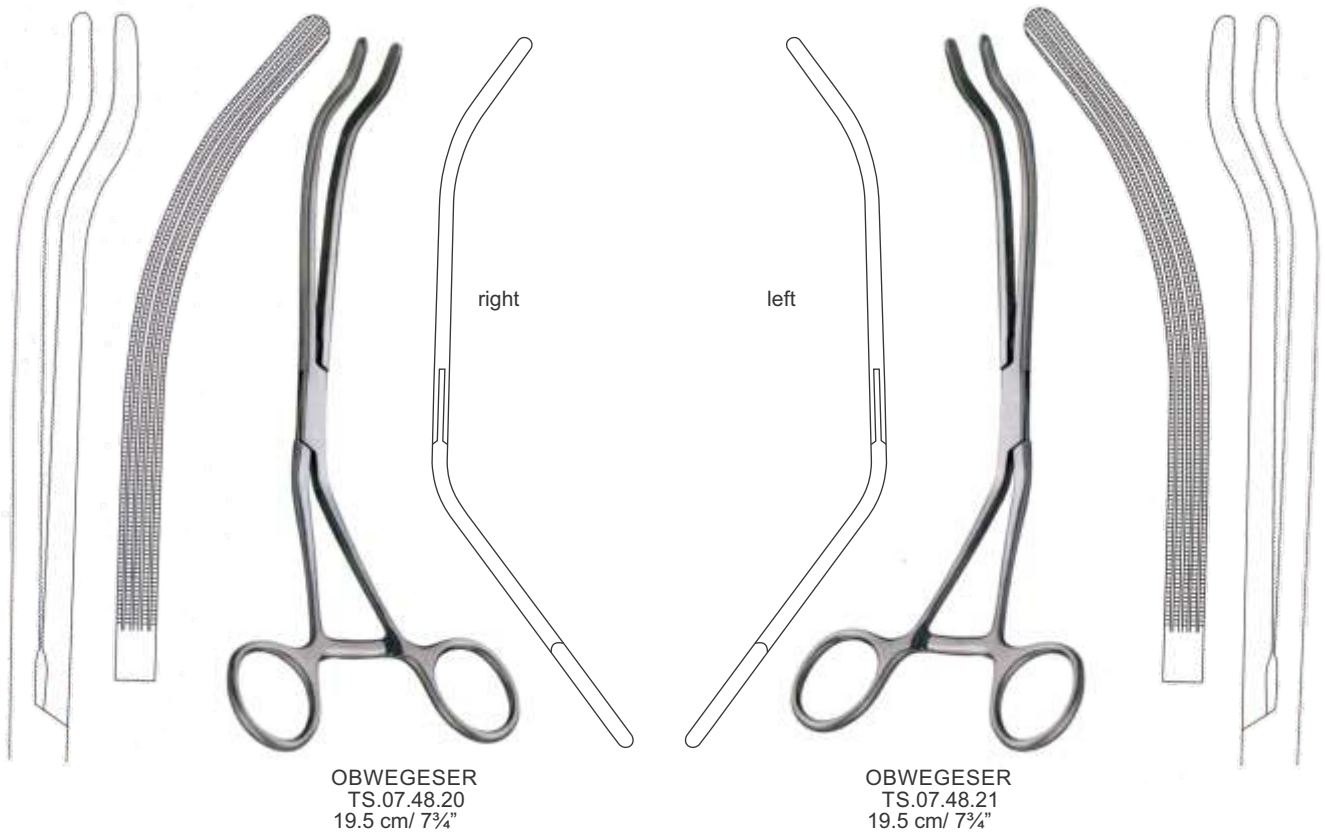

# Orthopedic Instruments

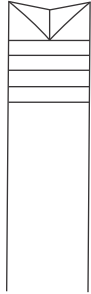

LANGENBECK  
TS.07.51.21  
21 cm / 8¼"



FERGUSSON  
TS.07.52.21  
21 cm / 8¼"

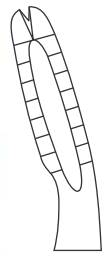

BIRCHER  
TS.07.53.20  
20 cm / 8"



BIRCHER  
TS.07.54.20  
20 cm / 8"



TS.07.55.23  
23 cm / 9"

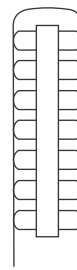

TS.07.55.25  
25 cm / 10"

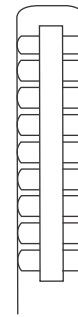

TS.07.55.28  
28 cm / 11"

TS.07.55.24  
23 cm / 9"

TS.07.55.26  
25 cm / 10"

TS.07.55.27  
28 cm / 11"

ULRICH



ULRICH



TS.07.56.14  
 14 cm / 5½"

TS.07.56.17  
 17 cm / 6¾"

TS.07.56.21  
 21 cm / 8¼"

TS.07.61.23  
 23 cm / 9"

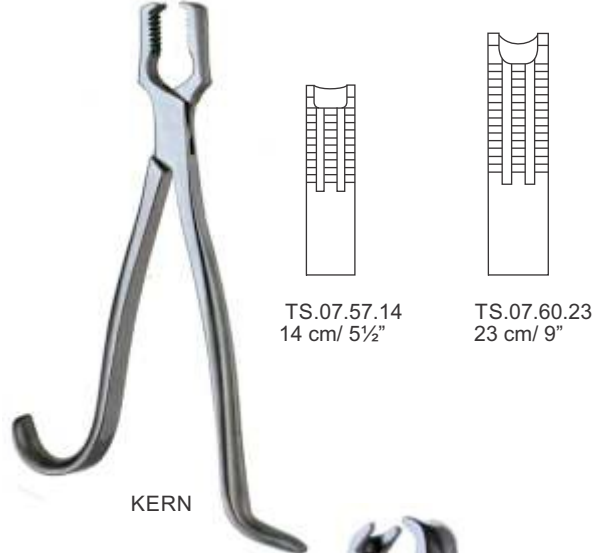

TS.07.57.14  
 14 cm / 5½"

TS.07.60.23  
 23 cm / 9"

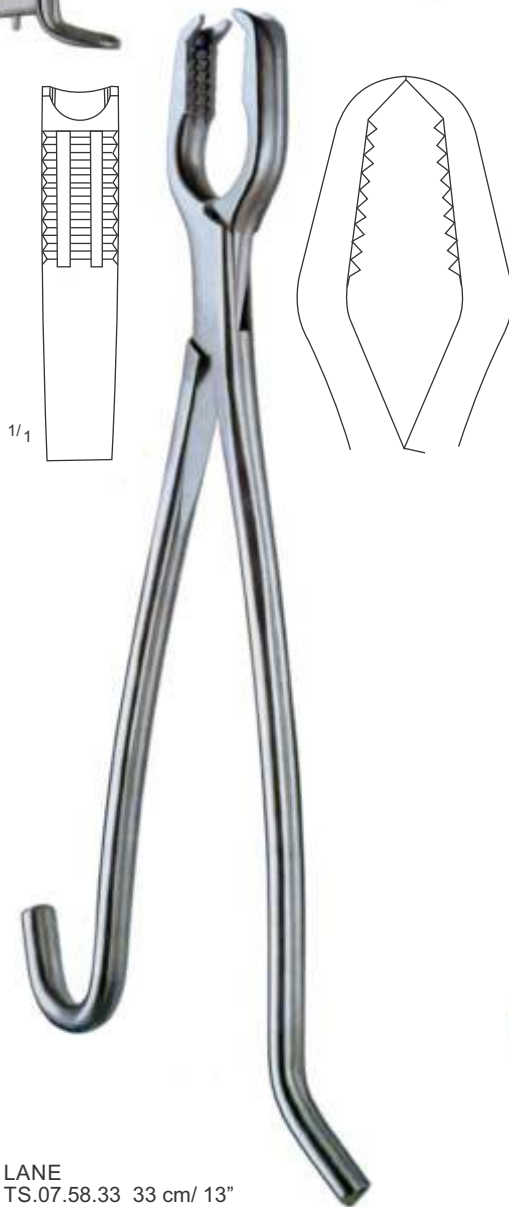

TS.07.58.33 33 cm / 13"  
 TS.07.58.45 41.5 cm / 16½"

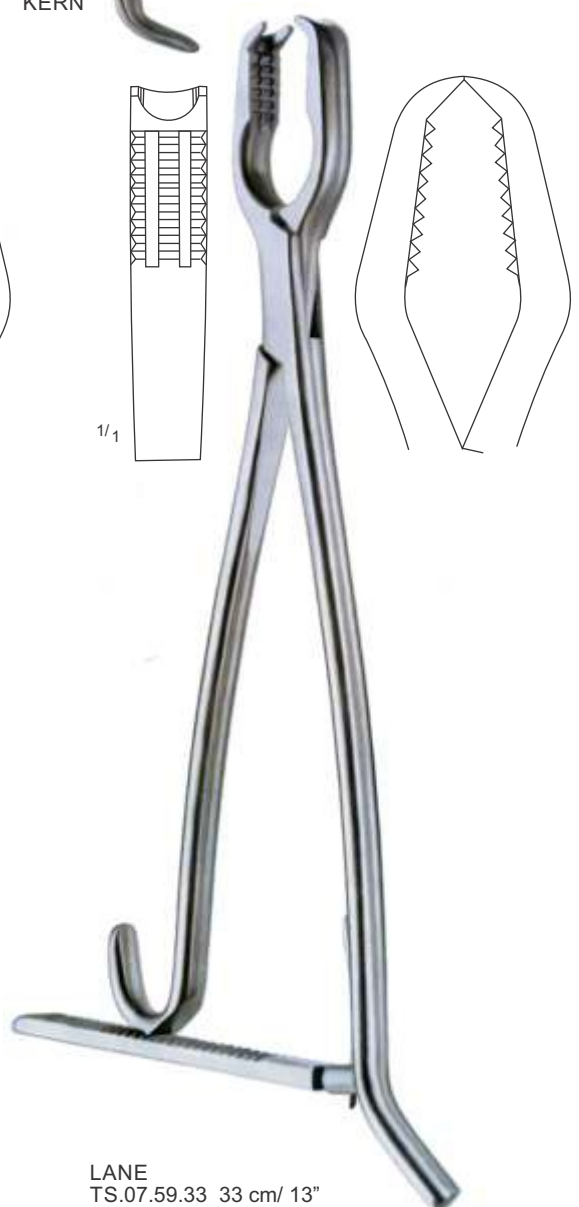

TS.07.59.33 33 cm / 13"  
 TS.07.59.45 41.5 cm / 16½"

# Orthopedic Instruments



LAMBOTTE  
TS.07.62.21 - 21 cm / 8¼"  
TS.07.62.25 - 25 cm / 10"  
TS.07.62.30 - 30 cm / 11¾"

LAMBOTTE  
TS.07.63.21 - 21 cm / 8¼"  
TS.07.63.26 - 26 cm / 10¼"  
TS.07.63.33 - 30 cm / 11¾"

FARABEU  
TS.07.64.23 23 cm / 9"  
TS.07.64.25 25 cm / 10"

Bone holding clamps



FARABEU-F-LAMBOTTE  
 TS.07.65.26  
 26 cm/ 10¼"



VERBRUGGE  
 TS.07.66.17  
 17.5 cm/ 7"



VERBRUGGE  
 TS.07.67.25 25 cm/ 10"  
 TS.07.67.26 26 cm/ 10¼"  
 TS.07.67.27 27 cm/ 10¾"



# Orthopedic Instruments

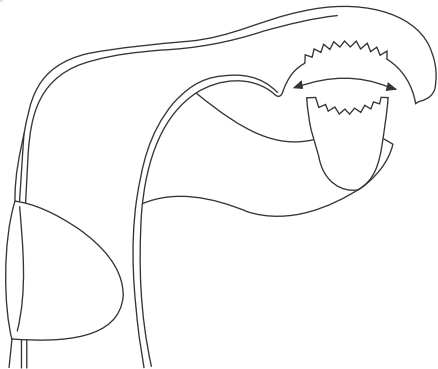
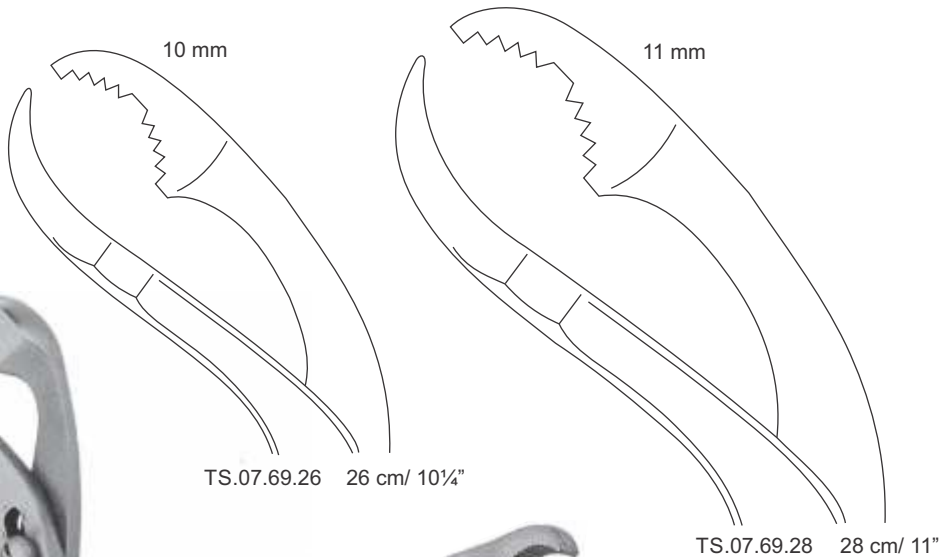
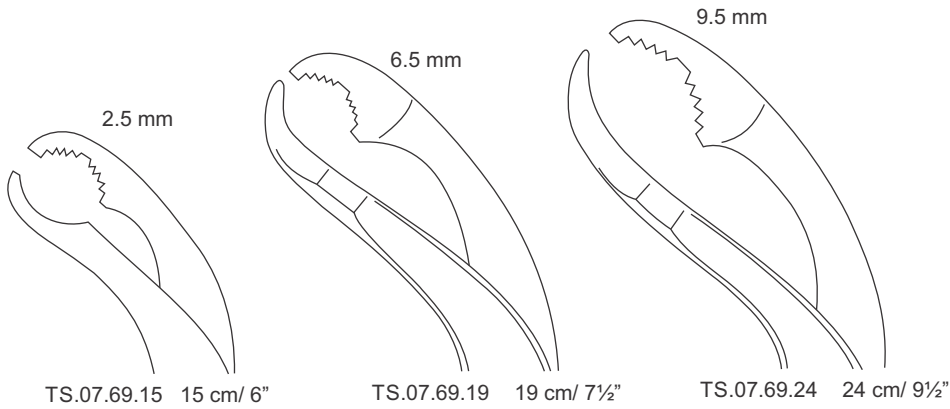

LAMBOTTE  
TS.07.68.21 - 21 cm / 8¼"  
TS.07.68.23 - 23 cm / 9"

TS.07.73.01 12 mm  
TS.07.73.02 18 mm  
Spare blades

TS.07.72.30  
Spare blade



TS.07.70.14  
17.5 cm - 7"



LANGENBECK  
TS.07.70.23  
23 cm - 9"



CHARRIERE  
TS.07.71.27 - 27 cm/10 $\frac{3}{4}$ "  
TS.07.71.30 - 30 cm/11 $\frac{3}{4}$ "  
TS.07.71.34 - 34 cm/13 $\frac{3}{8}$ "



SATTERLEE  
TS.07.72.29  
29 cm - 11 $\frac{1}{2}$ "



CHARRIERE  
TS.07.73.35  
35 cm - 13 $\frac{3}{4}$ "

# Orthopedic Instruments



TS.07.73.04 4 mm  
TS.07.73.06 6 mm  
TS.07.73.08 8 mm  
Spare blades

BIER  
TS.07.73.42  
42 cm - 16½"

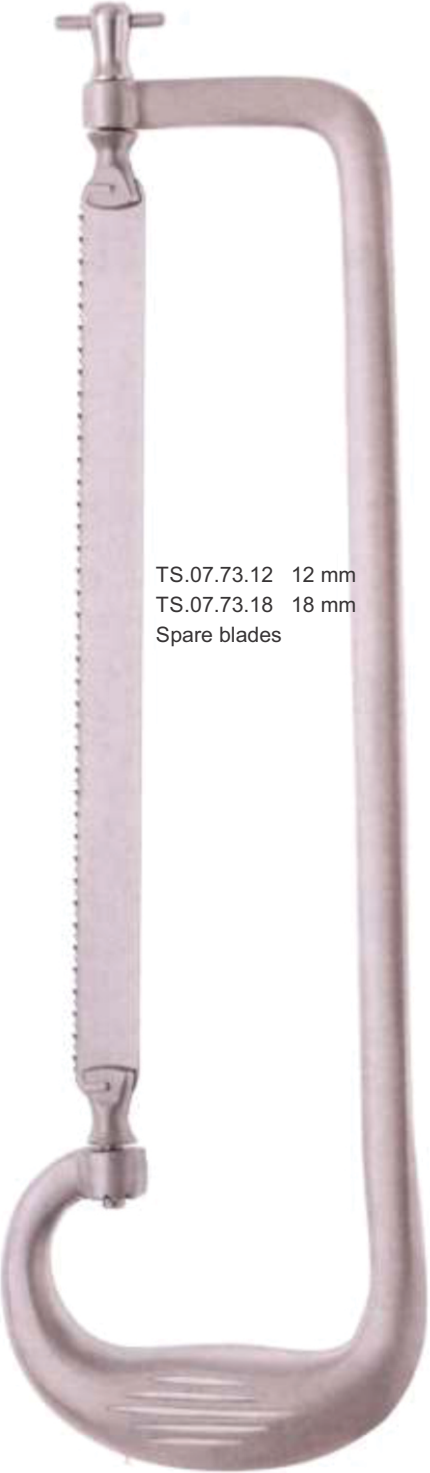

TS.07.73.12 12 mm  
TS.07.73.18 18 mm  
Spare blades

RUST  
TS.07.73.38  
38 cm/ 15"



GIGLI  
 TS.07.74.02  
 (Pair of Handles)

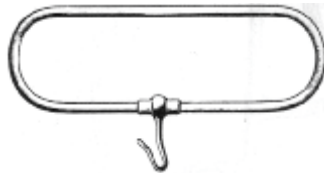

GIGLI  
 TS.07.74.06  
 (Supplied In Pairs)



GIGLI  
 TS.07.74.30 - 30 cm / 11 3/4"  
 TS.07.74.40 - 40 cm / 15 3/4"  
 TS.07.74.50 - 50 cm / 19 3/4"  
 TS.07.74.60 - 60 cm / 23 3/4"  
 TS.07.74.70 - 70 cm / 27 1/2"



DeMARTEL  
 wire saw guide  
 TS.07.74.80  
 33 cm / 13"

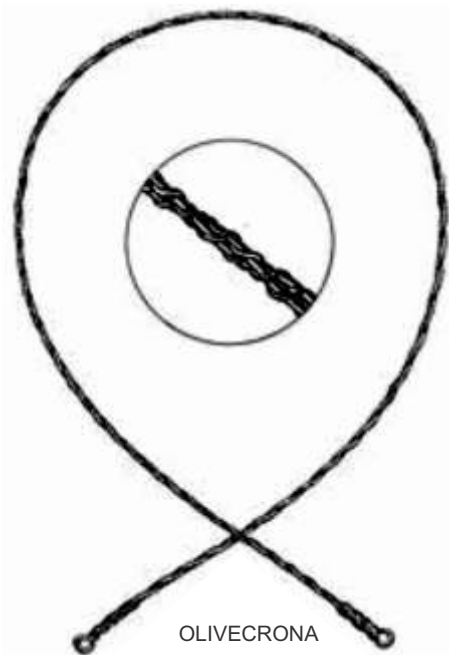

OLIVECRONA  
 TS.07.74.90  
 50 cm / 20"



TS.07.76.12  
 9 x 16 cm  
 3 1/2" - 6 1/4"  
 Complete with 1 nail Ø 4 mm x 15 cm  
 for arm

TS.07.76.13  
 11 x 21 cm  
 4 3/8" - 8 1/4"  
 Complete with 1 nail Ø 4 mm x 18 cm  
 for knee and femur

TS.07.76.15  
 15 x 21 cm  
 3" - 8 1/4"  
 Complete with 1 nail Ø 4 mm x 21 cm  
 for knee and femur

# Orthopedic Instruments



ERICH  
TS.07.75.05  
Roll/1 m



Arch bars

ERICH  
TS.07.75.10  
14 cm/ 5½"  
packing unit 12 pieces  
tück

Arch bars



SCHUCHARDT  
TS.07.75.01  
packing unit 12 pieces



DAUTREY  
TS.07.75.23  
15 cm - 6"



SCHUCHARDT  
TS.07.75.02  
packing unit 12 pieces



Coil 10 m (33.3 ft.), soft

- TS.07.74.17 Ø 0.25 mm - 31 G
- TS.07.74.18 Ø 0.30 mm - 29 G
- TS.07.74.19 Ø 0.40 mm - 27 G
- TS.07.74.20 Ø 0.50 mm - 25 G
- TS.07.74.21 Ø 0.60 mm - 23 G
- TS.07.74.22 Ø 0.70 mm - 22 G
- TS.07.74.23 Ø 0.80 mm - 21 G
- TS.07.74.24 Ø 0.90 mm - 20 G
- TS.07.74.25 Ø 1.00 mm - 19 G
- TS.07.74.32 Ø 1.20 mm - 18 G
- TS.07.74.33 Ø 1.50 mm - 17 G
- TS.07.74.34 Ø 1.80 mm - 15 G
- TS.07.74.35 Ø 2.00 mm - 14 G



TS.07.78.05  
with three-jaw chuck, locked  
by hand, max. spread 8 mm



TS.07.78.07  
with Jacobs three-jaw chuck and tightening  
wrench max. spread 7 mm



Wire pusher

MERSHON  
 TS.07.04.50  
 14.5 cm - 5¾"



NIRO  
 TS.07.04.15  
 14 cm - 5½"



NIRO "TC"  
 TS.07.04.65  
 14 cm - 5½"



MEDICON  
 TS.07.80.07  
 17 cm - 6¾"



MEDICON "TC"  
 TS.07.80.17  
 17 cm - 6¾"

# Orthopedic Instruments

Bone drill



CHAMPIONNIER  
TS.07.79.17  
17 cm - 6¾"



REAMER  
TS.07.79.54  
15 cm - 6"



PERTHES  
TS.07.79.21  
21 cm - 8¼"



PERTHES  
TS.07.79.41  
22 cm - 8¾"

complete with 3 traction hooks



TS.07.79.26  
16 cm - 6¼"



K.WIRE (KIRSCHNER)  
TS.07.79.01 small pattern  
TS.07.79.02 large pattern

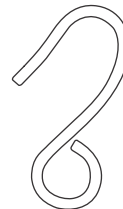

TS.07.79.71  
Traction hook only, small

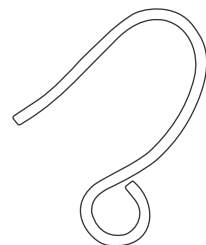

TS.07.79.72  
Traction hook only, large



TS.07.78.21      a = 4.5 - 13 cm  
small pattern      1<sup>3</sup>/<sub>4</sub>"-5<sup>1</sup>/<sub>8</sub>"  
b = 10 cm  
4"

TS.07.78.23      a = 7 - 19 cm  
large pattern      2<sup>3</sup>/<sub>4</sub>"-7<sup>1</sup>/<sub>2</sub>"  
b = 16 cm  
6<sup>1</sup>/<sub>4</sub>"

**KIRSCHNER**  
complete with 3 traction hooks



TS.07.78.25  
15 cm - 6"  
Tightening wrench



# Orthopedic Instruments



TS.07.80.01



TS.07.80.02

17 cm / 6 $\frac{3}{4}$ "

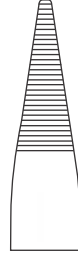

TS.07.80.29  
19 cm / 7 $\frac{1}{2}$ "



TS.07.80.15  
15 cm / 6"  
"TC"



UNIVERSAL  
TS.07.82.15  
15 cm / 6"



5 mm  
TS.07.84.08



7 mm  
TS.07.85.08



TS.07.86.08

18 cm / 7 $\frac{1}{8}$ "



TS.07.83.18



TS.07.84.18



TS.07.85.18

18 cm / 7 $\frac{1}{8}$ "



ALITUR "TC"  
 TS.07.87.03  
 3 mm jaws  
  
 TS.07.87.06  
 6 mm jaws  
 18cm/ 7 $\frac{1}{8}$ "



TS.07.88.18  
 18 cm/ 7 $\frac{1}{8}$ "



TS.07.88.20  
 20 cm/ 8"

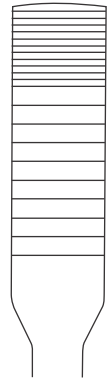

TS.07.88.24  
 24 cm/ 9 $\frac{1}{2}$ "

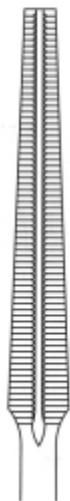

TS.07.89.22  
 22 cm/ 8 $\frac{3}{4}$ "



TS.07.89.25  
 25 cm/ 10"

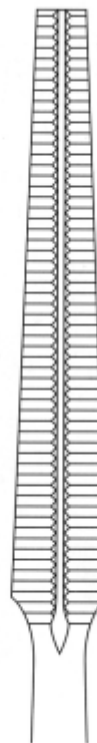

TS.07.89.30  
 30 cm/ 11 $\frac{1}{4}$ "



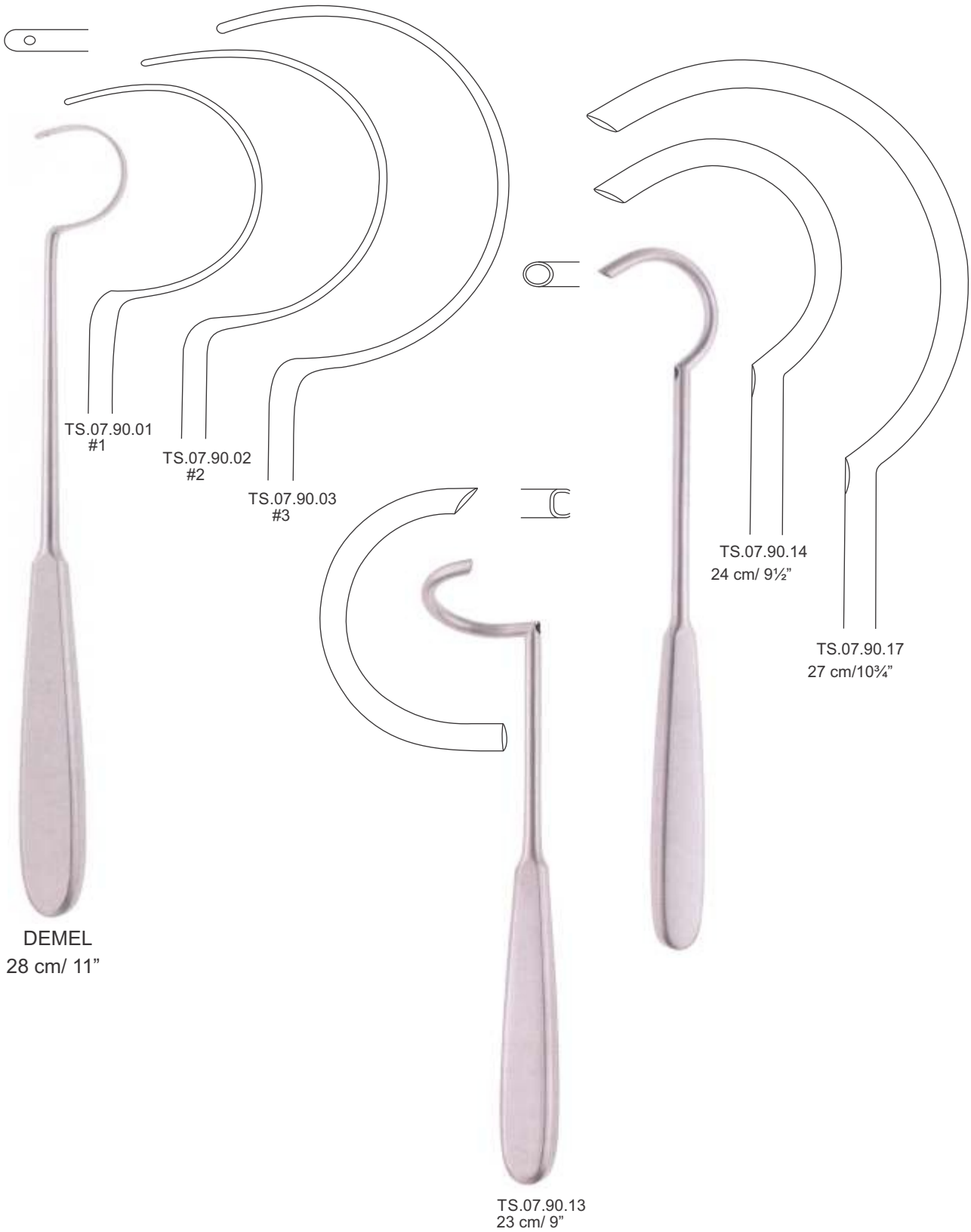

with NOVOTEX plastic handle (autoclavable up to 134° C at 3 bar)

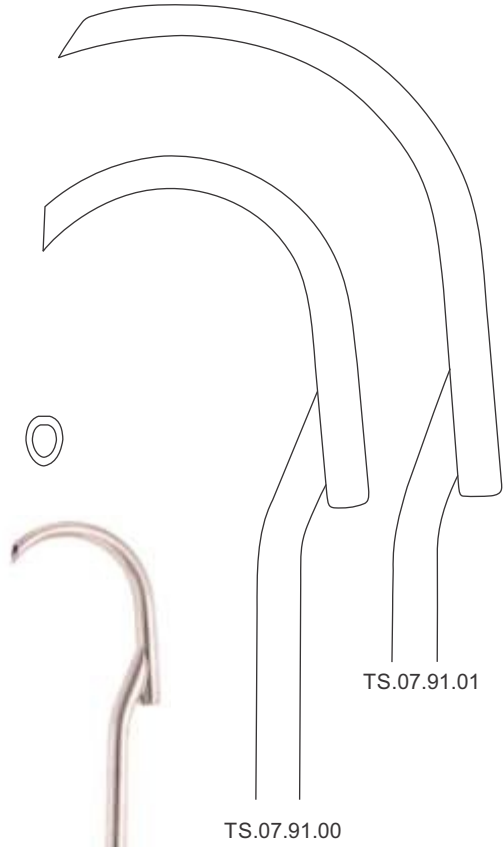

TS.07.91.00  
 TS.07.91.01



21 cm/ 8¼"



LOUTE  
 TS.07.90.21  
 22 cm/ 8¾"



DEMEL  
 TS.07.91.60  
 28 cm/11"

# Orthopedic Instruments

with side cutter for wires up to max. Ø 1.6 mm



TS.07.89.17  
18 cm / 7<sup>1</sup>/<sub>8</sub>"

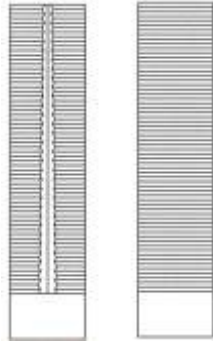

TS.07.89.118  
18.5 cm / 7<sup>1</sup>/<sub>4</sub>"

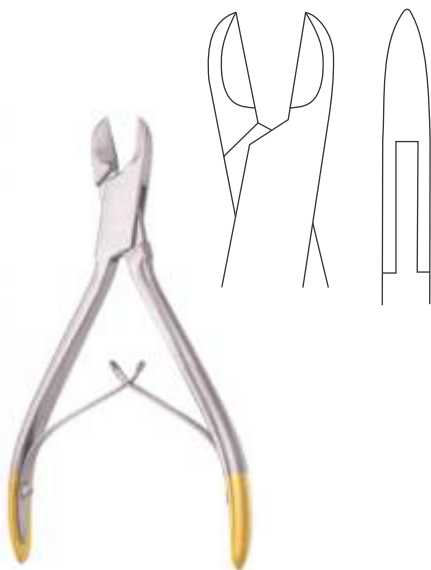
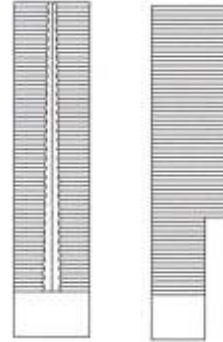

TS.07.91.11  
12 cm / 4<sup>3</sup>/<sub>4</sub>"  
"TC"  
hard wire max. 0.6 mm  
soft wire max. 1.0 mm

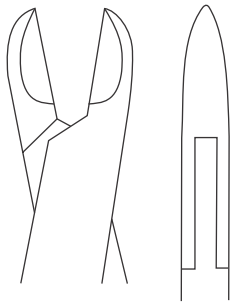

TS.07.91.13  
13 cm / 5<sup>1</sup>/<sub>8</sub>"  
"TC"  
hard wire max. 1.2 mm  
soft wire max. 1.6 mm

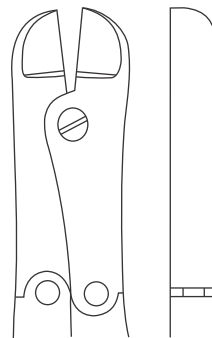

TS.07.91.15  
15 cm / 6"  
"TC"  
hard wire max. 1.5 mm  
soft wire max. 2.0 mm



# Orthopedic Instruments



TS.07.92.16  
 16 cm / 6 1/4"  
 hard wire max. 1.5 mm  
 soft wire max. 2.0 mm



TS.07.93.73  
 21 cm / 8 1/4"  
 "TC"  
 hard wire max. 2.5 mm



TS.07.93.47  
 18.5 cm - 7 1/4"  
 hard wire max. 1.6 mm



TS.07.93.53  
 23 cm / 9"  
 hard wire max. 2.5 mm



TS.07.94.18  
 19 cm / 7 1/2"  
 hard wire max. 1.5 mm  
 soft wire max. 2.0 mm

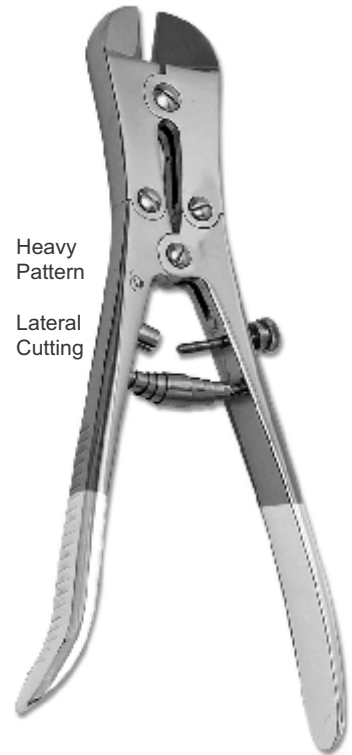
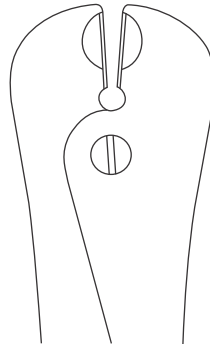

Heavy  
 Pattern

Lateral  
 Cutting

TS.07.95.54  
 24 cm / 9 1/2"  
 "TC"

# Orthopedic Instruments

Vertebral cutting forceps

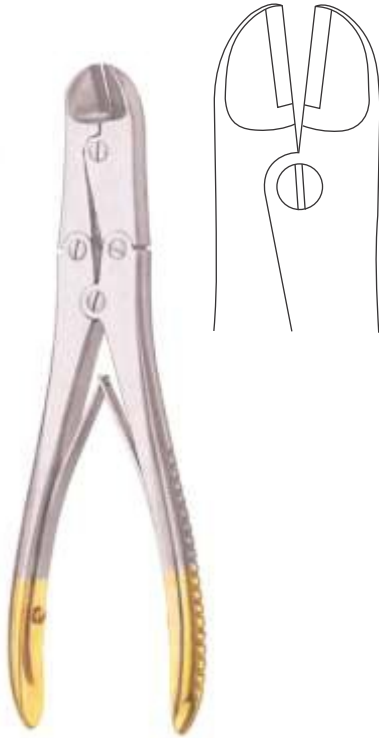

TS.07.96.17  
17.5 cm/ 7"  
"TC"



For Hard Wires  
upto  $\varnothing$  2.5 mm

TS.07.98.22  
22 cm/ 8 $\frac{3}{4}$ "  
"TC"



HARMS  
TS.07.98.55  
18 cm/ 7 $\frac{1}{8}$ "  
"TC"



TS.07.98.60  
18 cm/ 7 $\frac{1}{8}$ "  
"TC"  
hard wire max.  $\varnothing$  1.6 mm  
soft wire max.  $\varnothing$  2.0 mm

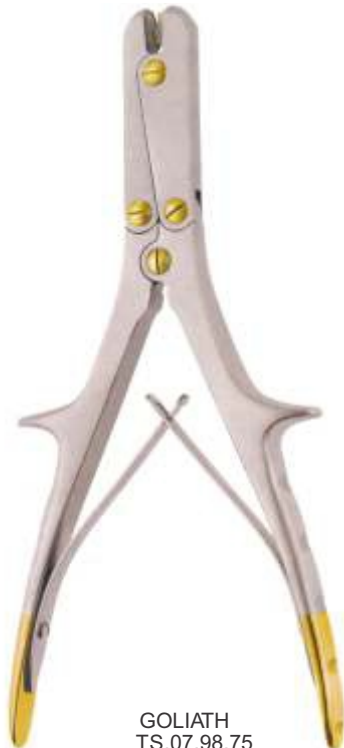

GOLIATH  
TS.07.98.75  
25 cm/ 10"  
"TC"  
hard wire max.  $\varnothing$  3.0 mm



Plastic inserts hold wire piece  
after being cut.



Easy Cut  
TS.07.98.85  
20 cm/ 8"  
"TC"  
hard wires max. Ø1.8 mm



Plastic inserts hold wire piece after being cut.



TS.07.99.80  
45 cm/ 17¾"



TS.07.99.79  
26 cm/ 10¼"  
hard wires max. Ø3.0 mm





Orthopedic Instruments



- TS.07.01.02 2 mm
- TS.07.01.03 3 mm
- TS.07.01.04 4 mm
- TS.07.01.06 6 mm
- TS.07.01.08 8 mm
- TS.07.01.10 10 mm
- TS.07.01.12 12 mm
- TS.07.01.15 15 mm

TS.07.01.90  
Set complete in canvas roll

**MINI-LAMBOTTE**  
13 cm / 5 $\frac{1}{8}$ "



- TS.07.01.52 2 mm
- TS.07.01.53 3 mm
- TS.07.01.54 4 mm
- TS.07.01.56 6 mm
- TS.07.01.58 8 mm
- TS.07.01.60 10 mm
- TS.07.01.62 12 mm
- TS.07.01.65 15 mm

TS.07.01.95  
Set complete in canvas roll

**MINI-LAMBOTTE**  
17 cm / 6 $\frac{3}{4}$ "



- TS.07.02.02 2 mm
- TS.07.02.04 4 mm
- TS.07.02.06 6 mm
- TS.07.02.08 8 mm
- TS.07.02.10 10 mm
- TS.07.02.12 12 mm
- TS.07.02.15 15 mm

TS.07.02.90  
Set complete in canvas roll

**HARDT-DELIMA**  
13 cm / 5 $\frac{1}{8}$ "



- TS.07.02.52 2 mm
- TS.07.02.54 4 mm
- TS.07.02.56 6 mm
- TS.07.02.58 8 mm
- TS.07.02.60 10 mm
- TS.07.02.62 12 mm
- TS.07.02.65 15 mm

TS.07.02.95  
Set complete in canvas roll

**HARDT-DELIMA**  
17 cm / 6 $\frac{3}{4}$ "

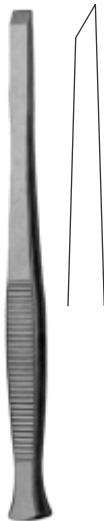

- TS.07.05.02 2 mm
- TS.07.05.03 3 mm
- TS.07.05.04 4 mm
- TS.07.05.05 5 mm
- TS.07.05.06 6 mm
- TS.07.05.08 8 mm

**PARTSCH**  
14 cm / 5 $\frac{1}{2}$ "



- TS.07.05.52 2 mm
- TS.07.05.53 3 mm
- TS.07.05.54 4 mm
- TS.07.05.55 5 mm
- TS.07.05.56 6 mm
- TS.07.05.57 7 mm
- TS.07.05.58 8 mm

**PARTSCH**  
17 cm / 6 $\frac{3}{4}$ "



- TS.07.06.02 2 mm
- TS.07.06.03 3 mm
- TS.07.06.04 4 mm
- TS.07.06.05 5 mm
- TS.07.06.06 6 mm
- TS.07.06.08 8 mm

**PARTSCH**  
14 cm / 5 $\frac{1}{2}$ "

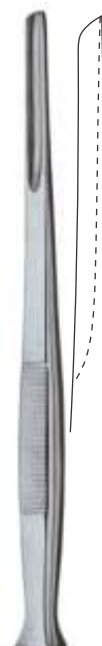

- TS.07.06.52 2 mm
- TS.07.06.53 3 mm
- TS.07.06.54 4 mm
- TS.07.06.55 5 mm
- TS.07.06.56 6 mm
- TS.07.06.57 7 mm
- TS.07.06.58 8 mm

**PARTSCH**  
17 cm / 6 $\frac{3}{4}$ "

# Orthopedic Instruments



- TS.07.07.02 2 mm
- TS.07.07.04 4 mm
- TS.07.07.06 6 mm
- TS.07.07.08 8 mm
- TS.07.07.10 10 mm
- TS.07.07.12 12 mm
- TS.07.07.15 15 mm
- TS.07.07.18 18 mm
- TS.07.07.20 20 mm

**SHEEHAN**  
16 cm/ 6¼"

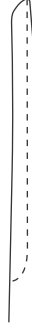

- TS.07.07.62 2 mm
- TS.07.07.63 3 mm
- TS.07.07.64 4 mm
- TS.07.07.66 6 mm

**SHEEHAN**  
16 cm/ 6¼"



- TS.07.08.04 4 mm
- TS.07.08.07 7 mm
- TS.07.08.09 9 mm
- TS.07.08.12 12 mm



**COTTLE**  
18 cm/ 7½"



- TS.07.11.10 10 mm
- TS.07.11.12 12 mm
- TS.07.11.15 15 mm
- TS.07.11.20 20 mm
- TS.07.11.25 25 mm

**STILLE**  
20 cm/ 8"



- TS.07.12.04 4 mm
- TS.07.12.06 6 mm
- TS.07.12.08 8 mm
- TS.07.12.10 10 mm
- TS.07.12.12 12 mm
- TS.07.12.15 15 mm
- TS.07.12.20 20 mm
- TS.07.12.25 25 mm

**STILLE**  
20 cm/ 8"



- TS.07.15.60 10 mm
- TS.07.15.62 12 mm
- TS.07.15.65 15 mm
- TS.07.15.70 20 mm
- TS.07.15.75 25 mm

**STILLE**  
20 cm/ 8"



- TS.07.16.06 6 mm
- TS.07.16.08 8 mm
- TS.07.16.10 10 mm
- TS.07.16.12 12 mm
- TS.07.16.15 15 mm
- TS.07.16.20 20 mm
- TS.07.16.25 25 mm

**STILLE**  
20 cm/ 8"



- TS.07.17.04 4 mm
- TS.07.17.06 6 mm
- TS.07.17.08 8 mm
- TS.07.17.10 10 mm
- TS.07.17.12 12 mm
- TS.07.17.14 14 mm

**ALEXANDER**  
18 cm/ 7½"

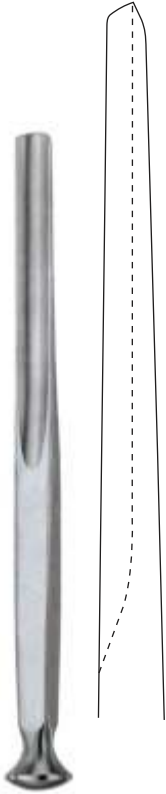

**ALEXANDER**  
18 cm / 7 1/8"

- TS.07.18.04 4 mm
- TS.07.18.05 5 mm
- TS.07.18.06 6 mm
- TS.07.18.07 7 mm
- TS.07.18.08 8 mm
- TS.07.18.09 9 mm
- TS.07.18.10 10 mm
- TS.07.18.11 11 mm
- TS.07.18.12 12 mm
- TS.07.18.14 14 mm



**STILLE**  
16 cm / 6 1/4"

- TS.07.19.06 6 mm
- TS.07.19.08 8 mm
- TS.07.19.10 10 mm
- TS.07.19.12 12 mm
- TS.07.19.15 15 mm



**STILLE**  
16 cm / 6 1/4"

- TS.07.20.04 4 mm
- TS.07.20.06 6 mm
- TS.07.20.08 8 mm
- TS.07.20.10 10 mm
- TS.07.20.12 12 mm
- TS.07.20.15 15 mm

4 mm



**FREER**  
17 cm / 6 3/4"

TS.07.21.10



TS.07.21.11



TS.07.21.19

4 mm



**WEST**  
TS.07.22.12  
16 cm / 6 1/4"

4 mm



**WEST**  
16 cm / 6 1/4"

TS.07.22.14

TS.07.22.15



14 cm / 5 1/2"

- TS.07.23.04 4 mm
- TS.07.23.06 6 mm
- TS.07.23.08 8 mm
- TS.07.23.10 10 mm
- TS.07.23.12 12 mm
- TS.07.23.14 14 mm
- TS.07.23.16 16 mm



14 cm / 5 1/2"

- TS.07.24.03 3 mm
- TS.07.24.04 4 mm
- TS.07.24.05 5 mm
- TS.07.24.06 6 mm
- TS.07.24.08 8 mm
- TS.07.24.10 10 mm
- TS.07.24.12 12 mm
- TS.07.24.14 14 mm
- TS.07.24.16 16 mm

# Orthopedic Instruments



- TS.08.25.03 3 mm
- TS.08.25.04 4 mm
- TS.08.25.05 5 mm
- TS.08.25.06 6 mm
- TS.08.25.08 8 mm
- TS.08.25.10 10 mm
- TS.08.25.12 12 mm
- TS.08.25.14 14 mm
- TS.08.25.16 16 mm

14 cm/ 5½"



- TS.08.26.03 Ø 3 mm
- TS.08.26.05 Ø 5 mm
- TS.08.26.07 Ø 7 mm
- TS.08.26.09 Ø 9 mm

16 cm/ 6¼"

Bone tamper



**HIBBS**  
24 cm/ 9½"

- TS.08.30.06 6 mm
- TS.08.30.12 12 mm
- TS.08.30.13 13 mm
- TS.08.30.19 19 mm
- TS.08.30.20 20 mm
- TS.08.30.25 25 mm
- TS.08.30.30 30 mm
- TS.08.30.32 32 mm
- TS.08.30.40 40 mm



**HIBBS**  
24 cm/ 9½"

- TS.08.31.06 6 mm
- TS.08.31.12 12 mm
- TS.08.31.13 13 mm
- TS.08.31.19 19 mm
- TS.08.31.20 20 mm
- TS.08.31.25 25 mm
- TS.08.31.30 30 mm
- TS.08.31.32 32 mm
- TS.08.31.40 40 mm



**HIBBS**  
24 cm/ 9½"

- TS.08.32.06 6 mm
- TS.08.32.12 12 mm
- TS.08.32.20 20 mm
- TS.08.32.25 25 mm
- TS.08.32.30 30 mm
- TS.08.32.32 32 mm
- TS.08.32.40 40 mm

# Orthopedic Instruments

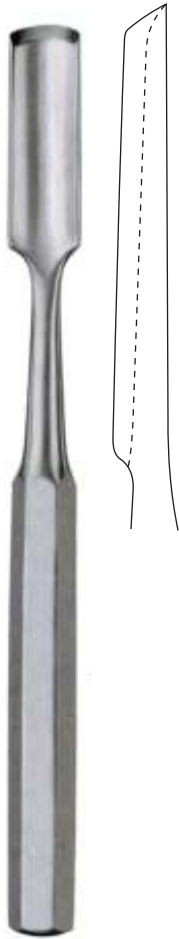

**HIBBS**  
 24 cm/ 9½"

- TS.08.33.06 6 mm
- TS.08.33.12 12 mm
- TS.08.33.20 20 mm
- TS.08.33.25 25 mm
- TS.08.33.30 30 mm
- TS.08.33.40 40 mm



**HIBBS**  
 24 cm/ 9½"

- TS.08.34.06 6 mm
- TS.08.34.12 12 mm
- TS.08.34.20 20 mm
- TS.08.34.25 25 mm
- TS.08.34.30 30 mm
- TS.08.34.40 40 mm

With Novotex Plastic Handle  
 (autoclavable Up To 134° C At 3 Bar)



- TS.08.35.04 4 mm
- TS.08.35.06 6 mm
- TS.08.35.08 8 mm
- TS.08.35.10 10 mm

**BRUNINGS**  
 16 cm/ 6¼"



- TS.08.35.34 4 mm
- TS.08.35.36 6 mm
- TS.08.35.38 8 mm
- TS.08.35.40 10 mm

**BRUNINGS**  
 16 cm/ 6¼"

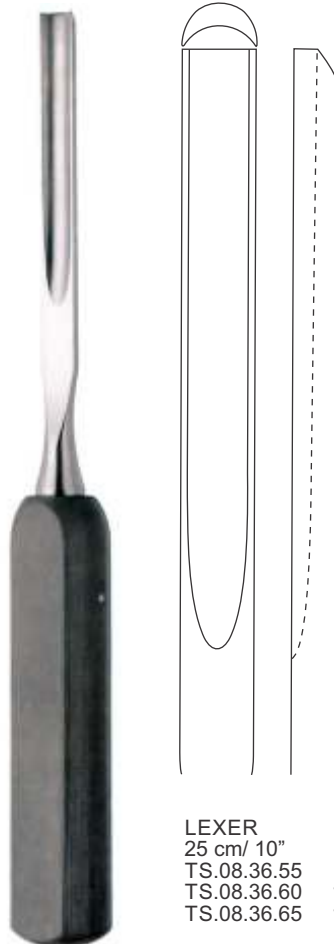

- LEXER**  
 25 cm/ 10"
- TS.08.36.55 5 mm
- TS.08.36.60 10 mm
- TS.08.36.65 15 mm

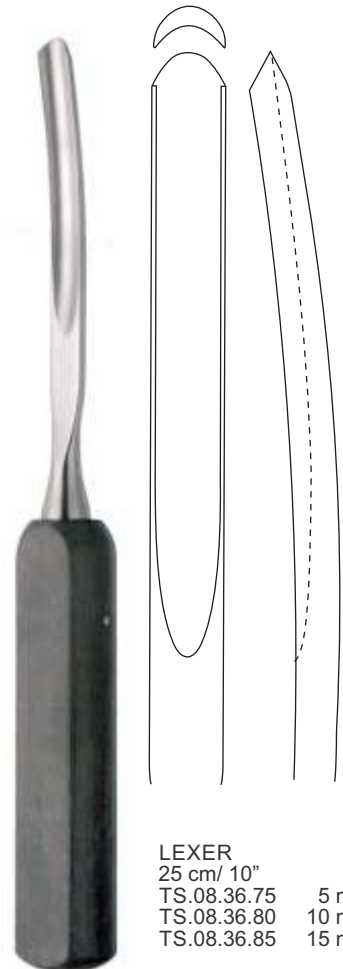

- LEXER**  
 25 cm/ 10"
- TS.08.36.75 5 mm
- TS.08.36.80 10 mm
- TS.08.36.85 15 mm

# Orthopedic Instruments

With Novotex Plastic Handle (autoclavable Up To 134° C At 3 Bar)

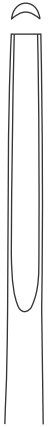

**COBB**  
28 cm/ 11"

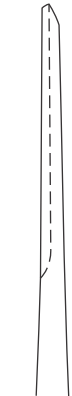

TS.08.36.91



TS.08.36.92



TS.08.36.93

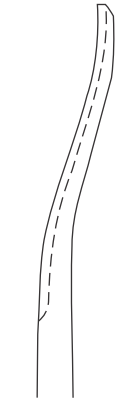

TS.08.36.94



**SMITH-PETERSEN**  
20 cm/ 8"

- TS.08.38.06 6 mm
- TS.08.38.09 9 mm
- TS.08.38.12 12 mm
- TS.08.38.15 15 mm
- TS.08.38.20 20 mm
- TS.08.38.25 25 mm
- TS.08.38.30 30 mm



**SMITH-PETERSEN**  
20 cm/ 8"

- TS.08.38.56 6 mm
- TS.08.38.59 9 mm
- TS.08.38.62 12 mm
- TS.08.38.65 15 mm
- TS.08.38.70 20 mm
- TS.08.38.75 25 mm
- TS.08.38.80 30 mm



TS.08.37.11  
3 mm



TS.08.37.12  
3.5 mm



Bone tamper

**PASSOW**  
12 cm/ 4¾"

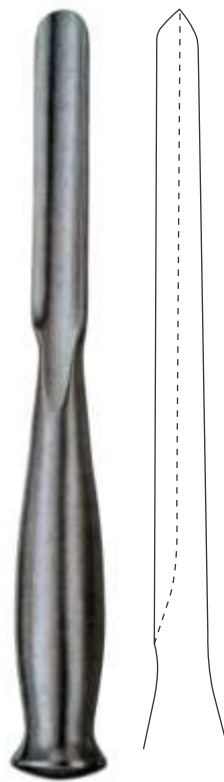
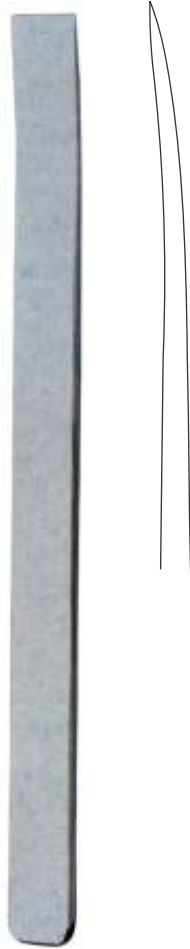
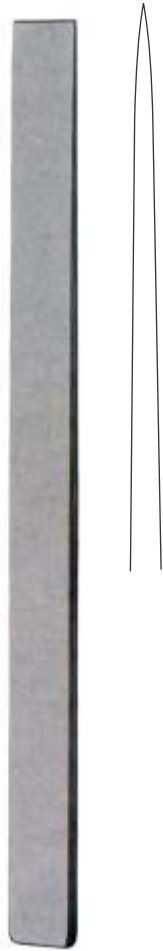

**LAMBOTTE**  
 24 cm / 9½"

TS.08.39.04	4 mm
TS.08.39.06	6 mm
TS.08.39.08	8 mm
TS.08.39.10	10 mm
TS.08.39.12	12 mm
TS.08.39.15	15 mm
TS.08.39.18	18 mm
TS.08.39.20	20 mm
TS.08.39.25	25 mm
TS.08.39.30	30 mm
TS.08.39.40	40 mm
TS.08.39.44	44 mm
TS.08.39.50	50 mm

**LAMBOTTE**  
 24 cm / 9½"

TS.08.39.54	4 mm
TS.08.39.56	6 mm
TS.08.39.58	8 mm
TS.08.39.60	10 mm
TS.08.39.62	12 mm
TS.08.39.65	15 mm
TS.08.39.70	20 mm
TS.08.39.75	25 mm
TS.08.39.80	30 mm
TS.08.39.90	40 mm
TS.08.39.94	44 mm
TS.08.39.99	50 mm

**SMITH-PETERSEN**  
 20 cm / 8"

TS.08.40.06	6 mm
TS.08.40.09	9 mm
TS.08.40.12	12 mm
TS.08.40.15	15 mm
TS.08.40.20	20 mm
TS.08.40.25	25 mm
TS.08.40.30	30 mm

**SMITH-PETERSEN**  
 20 cm / 8"

TS.08.40.56	6 mm
TS.08.40.59	9 mm
TS.08.40.62	12 mm
TS.08.40.65	15 mm
TS.08.40.70	20 mm
TS.08.40.75	25 mm
TS.08.40.80	30 mm



# Orthopedic Instruments

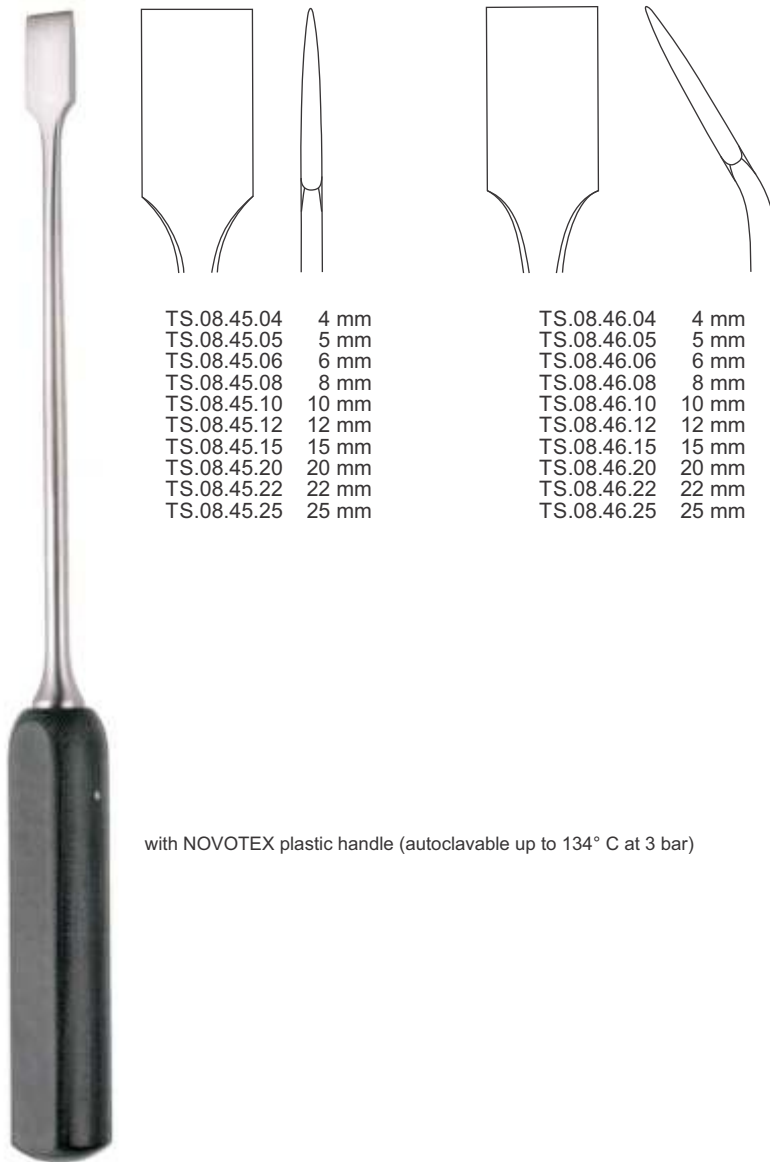

TS.08.45.04	4 mm
TS.08.45.05	5 mm
TS.08.45.06	6 mm
TS.08.45.08	8 mm
TS.08.45.10	10 mm
TS.08.45.12	12 mm
TS.08.45.15	15 mm
TS.08.45.20	20 mm
TS.08.45.22	22 mm
TS.08.45.25	25 mm

TS.08.46.04	4 mm
TS.08.46.05	5 mm
TS.08.46.06	6 mm
TS.08.46.08	8 mm
TS.08.46.10	10 mm
TS.08.46.12	12 mm
TS.08.46.15	15 mm
TS.08.46.20	20 mm
TS.08.46.22	22 mm
TS.08.46.25	25 mm

with NOVOTEX plastic handle (autoclavable up to 134° C at 3 bar)

DAHMEN  
30 cm/ 11¾"

# Orthopedic Instruments

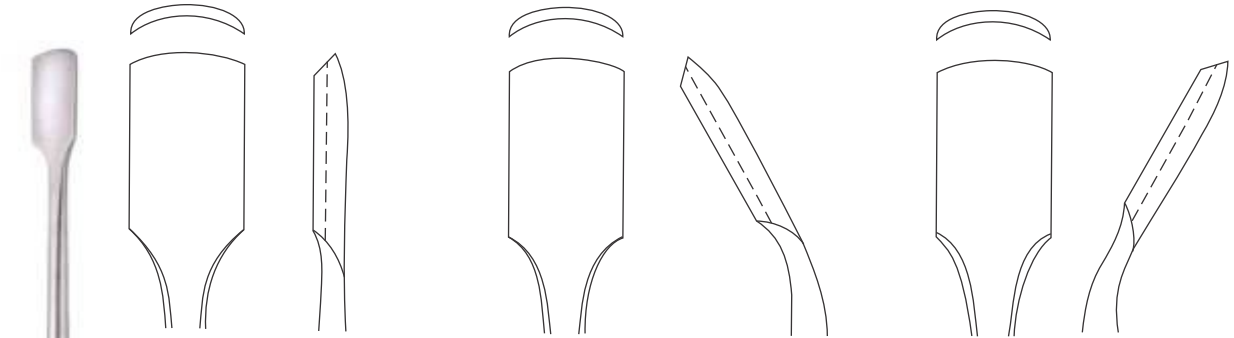

TS.08.47.04	4 mm
TS.08.47.05	5 mm
TS.08.47.06	6 mm
TS.08.47.08	8 mm
TS.08.47.10	10 mm
TS.08.47.12	12 mm
TS.08.47.15	15 mm
TS.08.47.20	20 mm
TS.08.47.22	22 mm
TS.08.47.25	25 mm

TS.08.48.04	4 mm
TS.08.48.05	5 mm
TS.08.48.06	6 mm
TS.08.48.08	8 mm
TS.08.48.10	10 mm
TS.08.48.12	12 mm
TS.08.48.15	15 mm
TS.08.48.20	20 mm
TS.08.48.22	22 mm
TS.08.48.25	25 mm

TS.08.49.04	4 mm
TS.08.49.05	5 mm
TS.08.49.06	6 mm
TS.08.49.08	8 mm
TS.08.49.10	10 mm
TS.08.49.12	12 mm
TS.08.49.15	15 mm
TS.08.49.20	20 mm
TS.08.49.22	22 mm
TS.08.49.25	25 mm

with NOVOTEX plastic handle (autoclavable up to 134° C at 3 bar)

**DAHMEN**  
 30 cm/ 11¾"

# Orthopedic Instruments

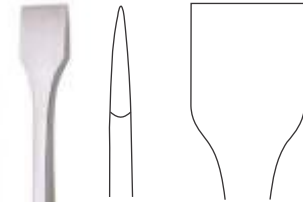

TS.08.54.02 2 mm  
TS.08.54.04 4 mm  
TS.08.54.06 6 mm  
TS.08.54.08 8 mm  
TS.08.54.10 10 mm  
TS.08.54.12 12 mm  
TS.08.54.15 15 mm  
TS.08.54.20 20 mm

**MINI-LEXER**  
18 cm / 7<sup>1</sup>/<sub>8</sub>"

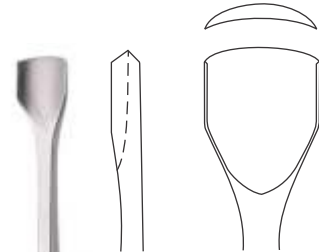

TS.08.56.02 2 mm  
TS.08.56.04 4 mm  
TS.08.56.06 6 mm  
TS.08.56.08 8 mm  
TS.08.56.10 10 mm  
TS.08.56.12 12 mm  
TS.08.56.15 15 mm  
TS.08.56.20 20 mm

**MINI-LEXER**  
18 cm / 7<sup>1</sup>/<sub>8</sub>"



TS.08.58.05 5 mm  
TS.08.58.07 7 mm  
TS.08.58.10 10 mm  
TS.08.58.12 12mm  
TS.08.58.15 15 mm  
TS.08.58.20 20 mm  
TS.08.58.25 25 mm  
TS.08.58.30 30 mm

**LEXER**  
22 cm / 8<sup>3</sup>/<sub>4</sub>"

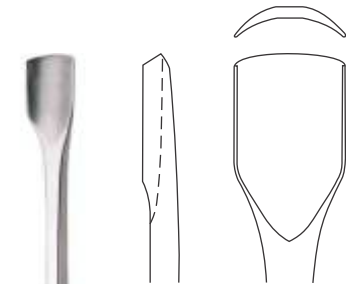

TS.08.60.05 5 mm  
TS.08.60.07 7 mm  
TS.08.60.10 10 mm  
TS.08.60.12 12mm  
TS.08.60.15 15 mm  
TS.08.60.20 20 mm  
TS.08.60.25 25 mm  
TS.08.60.30 30 mm

**LEXER**  
22 cm / 8<sup>3</sup>/<sub>4</sub>"

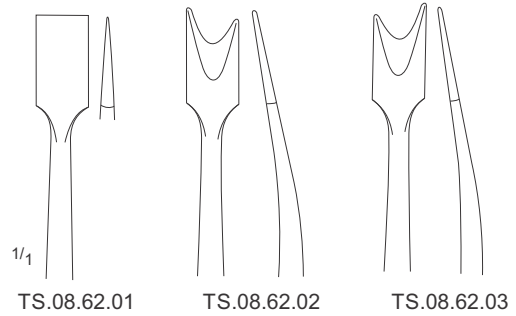

**SMILLIE**  
17 cm - 6<sup>3</sup>/<sub>4</sub>"

# Orthopedic Instruments

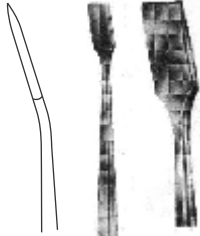

SMILLIE  
 TS.08.62.04  
 17 cm / 6 3/4"

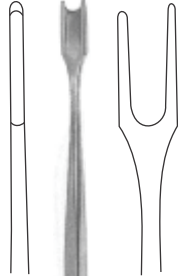

SMILLIE  
 TS.08.62.00  
 17 cm / 6 3/4"

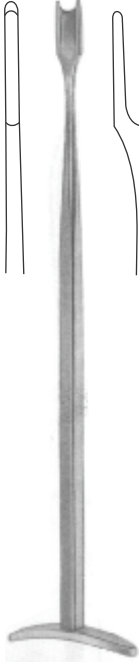

NEFF  
 TS.08.63.22  
 22 cm / 8 3/4"

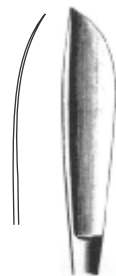

NEFF  
 TS.08.63.23  
 22 cm / 8 3/4"



SALENIUS  
 TS.08.63.32  
 22.5 cm / 9"

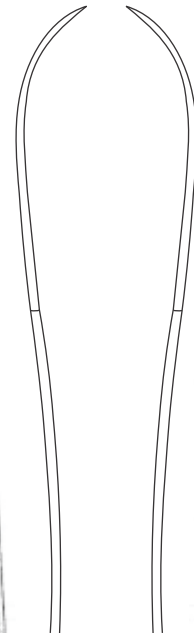

SALENIUS  
 TS.08.63.33  
 22.5 cm / 9"



# Orthopedic Instruments

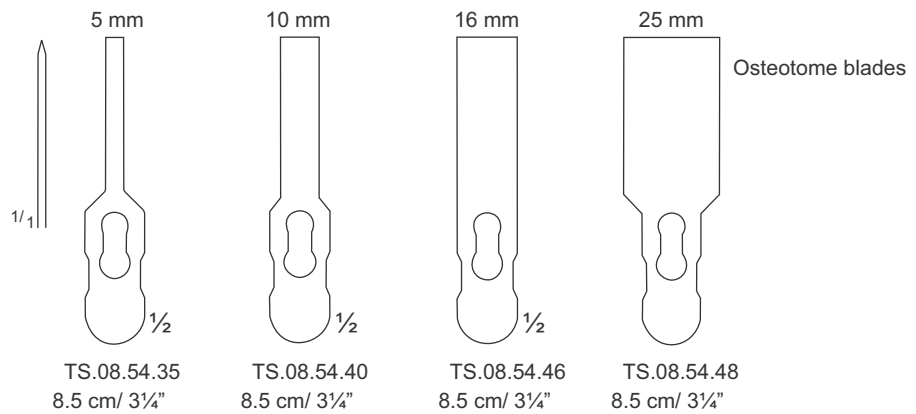
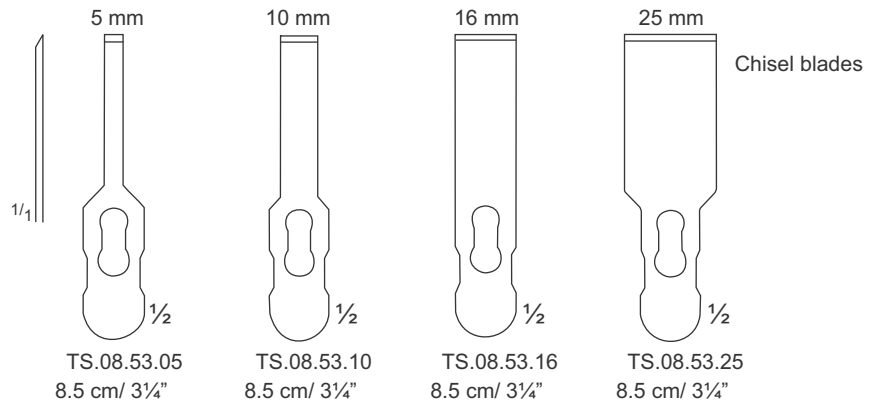

TS.08.53.02  
9 cm / 3 1/2"  
Wrench

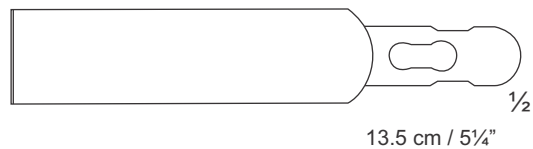
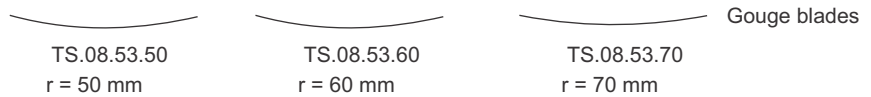



Orthopedic Instruments

# Orthopedic Instruments



TS.08.01.10  
# 0 - Ø 2 mm



TS.08.01.11  
# 1 - Ø 2.5 mm



TS.08.01.12  
# 2 - Ø 3 mm



TS.08.01.13  
# 3 - Ø 3.5 mm



TS.08.01.14  
# 4 - Ø 5 mm



**MEYERHOEFER**  
14 cm / 5½"



TS.08.02.01  
15 cm / 6"



TS.08.02.02  
15 cm / 6"



TS.08.02.03  
15 cm / 6"



**BRUNS**  
17 cm / 6¾"

TS.08.03.24  
# 000



TS.08.03.33  
# 000



TS.08.03.42  
# 000



TS.08.03.50  
# 0



TS.08.03.51  
# 1



TS.08.03.52  
# 2



TS.08.03.53  
# 3



TS.08.03.54  
# 4



TS.08.03.55  
# 5



TS.08.03.56  
# 6





**BUCK**  
14.5 cm / 5 3/4"

TS.08.04.01  
# 1



TS.08.04.02  
# 2



TS.08.04.03  
# 3



TS.08.04.04  
# 4



TS.08.04.05  
# 5



**WILLIGER**  
17 cm / 6 3/4"

TS.08.05.01  
# 1 - 4 mm



TS.08.05.51  
# 1 - 3.5 mm



TS.08.05.02  
# 2 - 5 mm



TS.08.05.52  
# 2 - 5.5 mm

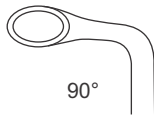

90°



**SIEBENMANN**  
TS.08.05.65  
16 cm / 6 1/4"



**SIEBENMANN**  
TS.08.05.66  
16 cm / 6 1/4"

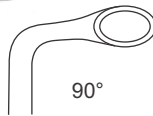

90°



**DAUBENSPECK**  
20 cm / 8"

TS.08.05.72  
# 00



TS.08.05.80  
# 0



TS.08.05.81  
# 1



TS.08.05.82  
# 2





# Orthopedic Instruments

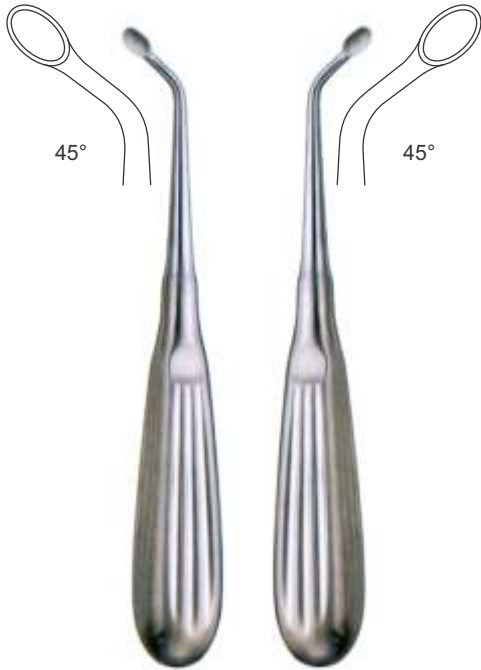

UFFENORDE  
TS.08.05.87  
17 cm / 6¾"

UFFENORDE  
TS.08.05.88  
17 cm / 6¾"



KERPEL  
15 cm / 6"



KERPEL  
15 cm / 6"



KERPEL  
15 cm / 6"



TS.08.06.01  
2 mm

TS.08.06.02  
3 mm



TS.08.06.03  
2 mm

TS.08.06.13  
3 mm



TS.08.06.04  
2 mm

TS.08.06.14  
3 mm



19.5 cm / 7¾"



TS.08.07.02  
Ø 2 mm



TS.08.07.03  
Ø 3 mm



TS.08.07.04  
Ø 4 mm

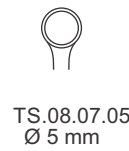

TS.08.07.05  
Ø 5 mm



TS.08.07.06  
Ø 6 mm



TS.08.07.07  
Ø 7 mm



TS.08.07.08  
Ø 8 mm



TS.08.07.10  
Ø 10 mm



TS.08.07.12  
Ø 12 mm

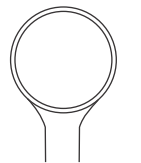

TS.08.07.14  
Ø 14 mm



20 cm/ 8"



TS.08.08.02  
2 mm



TS.08.08.03  
3 mm



TS.08.08.04  
4 mm



TS.08.08.05  
5 mm



TS.08.08.06  
6 mm



TS.08.08.07  
7 mm



TS.08.08.08  
8 mm



TS.08.08.10  
10 mm



TS.08.08.12  
12 mm

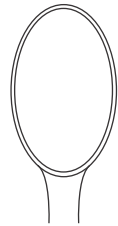

TS.08.08.14  
14 mm



BRUNS  
23 cm/ 9"



TS.08.09.24  
# 0000



TS.08.09.33  
# 000



TS.08.09.42  
# 00



TS.08.09.50  
# 0



TS.08.09.51  
# 1



TS.08.09.52  
# 2



TS.08.09.53  
# 3



TS.08.09.54  
# 4



TS.08.09.55  
# 5



TS.08.09.56  
# 6

# Orthopedic Instruments



TS.08.10.64  
# 0000

TS.08.10.73  
# 000

TS.08.10.82  
# 00

TS.08.10.90  
# 0

TS.08.10.91  
# 1

TS.08.10.92  
# 2

TS.08.10.93  
# 3

TS.08.10.94  
# 4

TS.08.10.95  
# 5

TS.08.10.96  
# 6

with NOVOTEX plastic handle (autoclavable up to 134° C at 3 bar)

BRUNS  
27 cm / 10 3/4"



TS.08.11.24 # 0000   TS.08.11.33 # 000   TS.08.11.42 # 00   TS.08.11.50 # 0

TS.08.11.51  
# 1

TS.08.11.52  
# 2

TS.08.11.53  
# 3

TS.08.11.54  
# 4

TS.08.11.55  
# 5

SPRATT  
18 cm / 7 1/8"



TS.08.12.06  
# 000000

TS.08.12.15  
# 00000

TS.08.12.24  
# 0000

TS.08.12.33  
# 000

TS.08.12.42  
# 00

TS.08.12.50  
# 0

TS.08.12.51  
# 1

TS.08.12.52  
# 2

LEMPERT  
21 cm / 8 1/4"

# Orthopedic Instruments

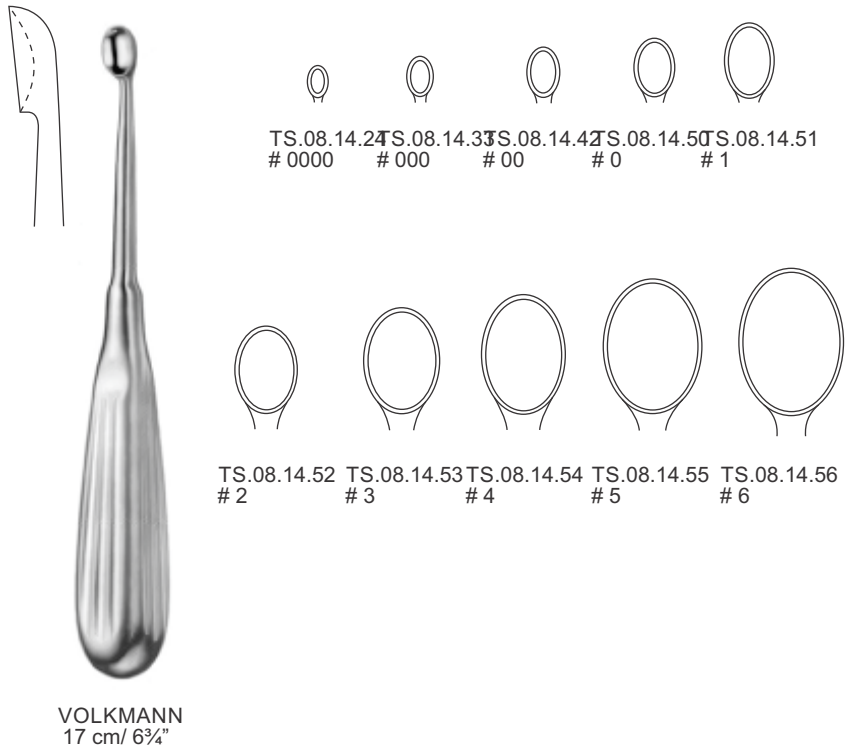
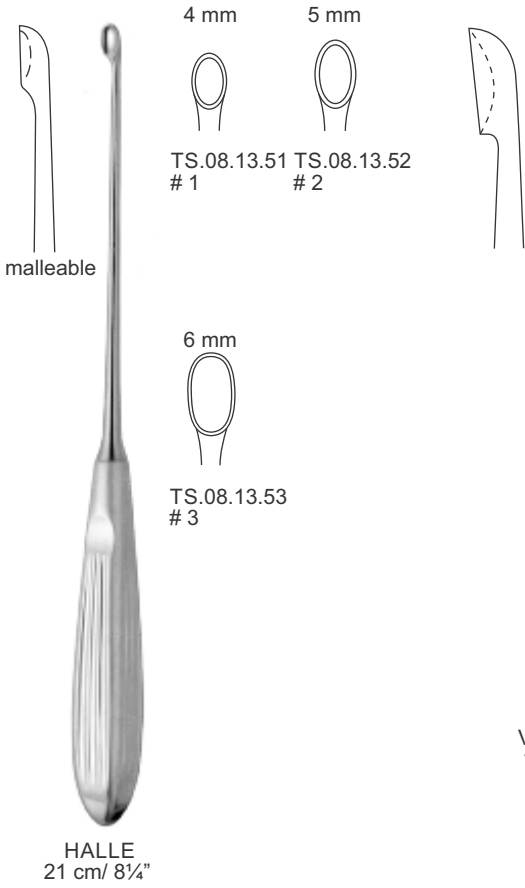

# Orthopedic Instruments



VOLKMANN  
23 cm / 9"



TS.08.16.24  
# 0000



TS.08.16.33  
# 000



TS.08.16.42  
# 00



TS.08.16.50  
# 0



TS.08.16.51  
# 1



TS.08.16.52  
# 2



TS.08.16.53  
# 3



TS.08.16.54  
# 4



TS.08.16.55  
# 5



TS.08.16.56  
# 6



VOLKMANN  
23 cm / 9"



TS.08.17.24  
# 0000



TS.08.17.33  
# 000



TS.08.17.42  
# 00



TS.08.17.50  
# 0



TS.08.17.51  
# 1



TS.08.17.52  
# 2



TS.08.17.53  
# 3



TS.08.17.54  
# 4



TS.08.17.55  
# 5

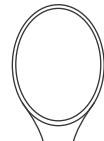

TS.08.17.56  
# 6

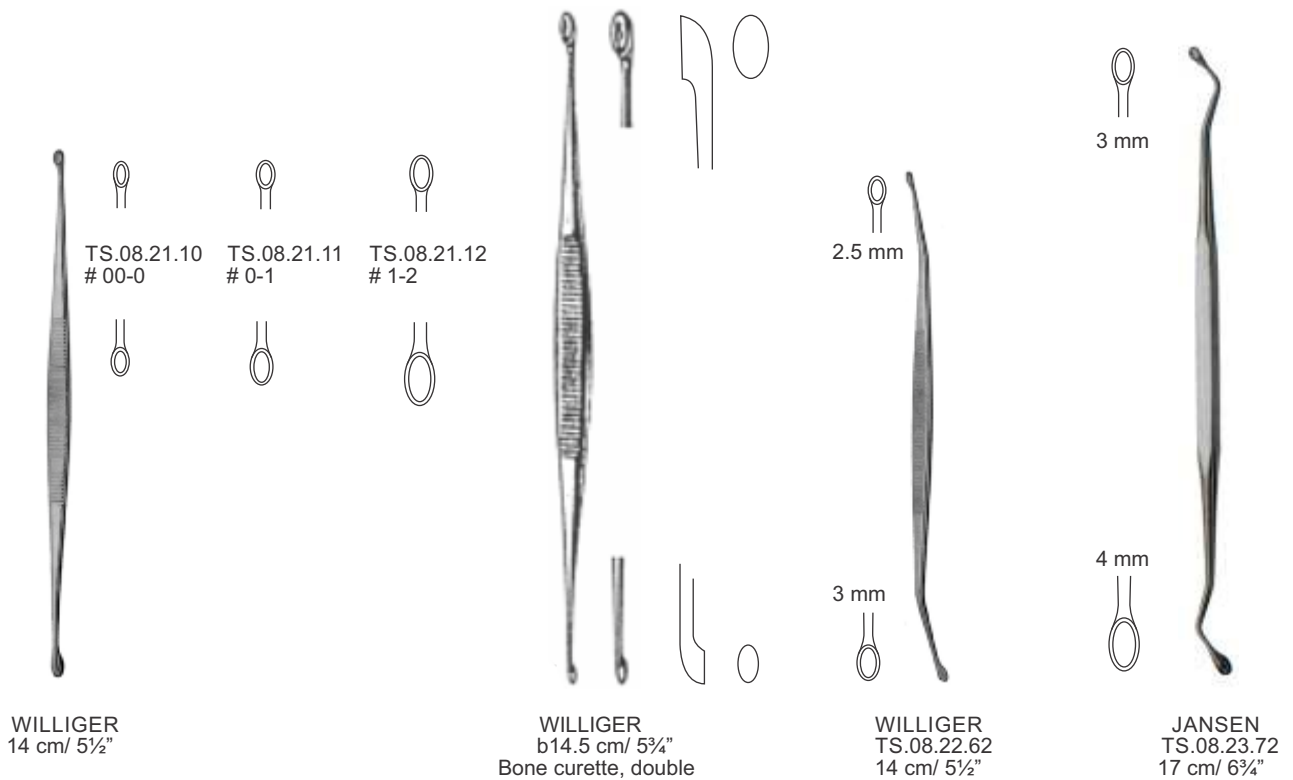
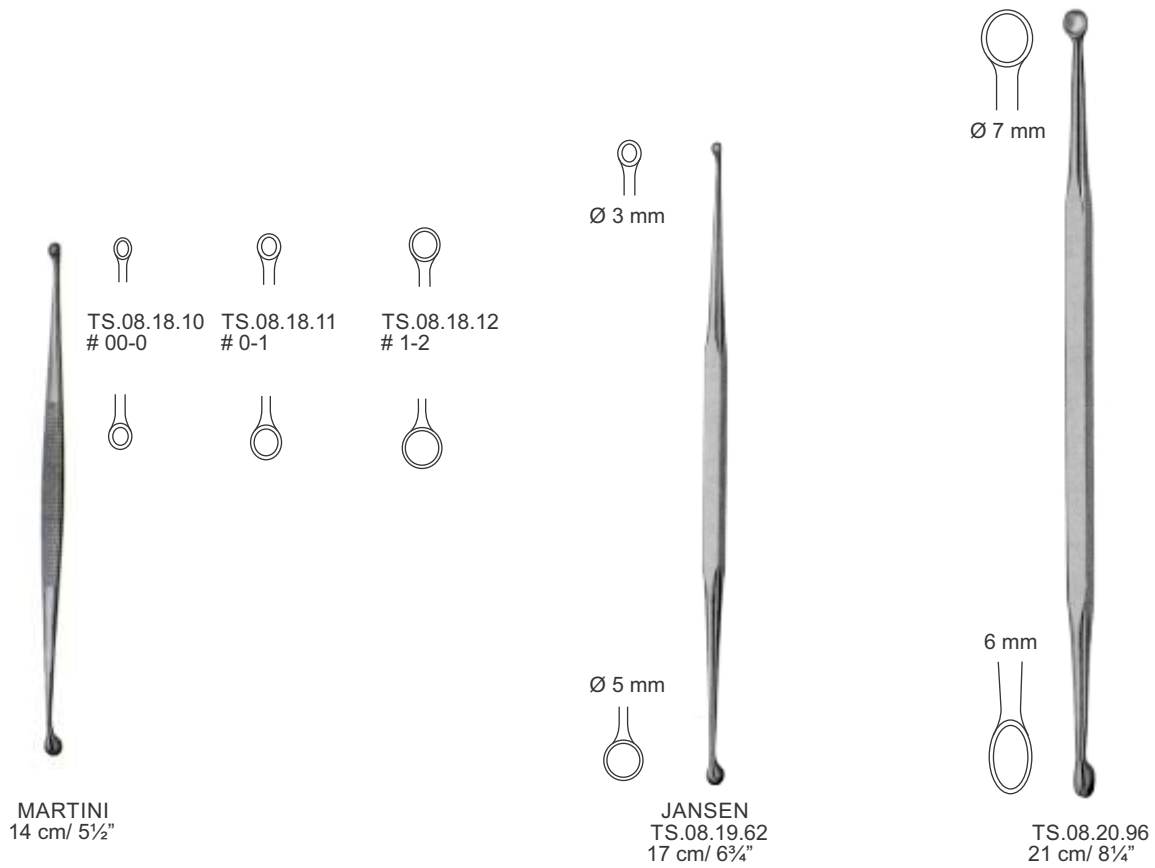

# Orthopedic Instruments



**HEMINGWAY**  
18 cm / 7 1/8"

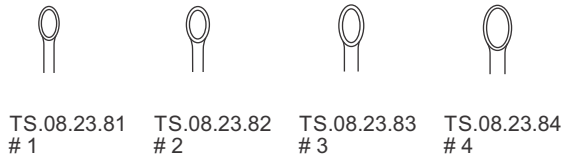

TS.08.23.81 # 1    TS.08.23.82 # 2    TS.08.23.83 # 3    TS.08.23.84 # 4



**VOLKMANN**  
TS.08.24.13 13 cm / 5 1/8"  
TS.08.24.14 14.5 cm / 5 3/4"



**VOLKMANN**  
TS.08.24.17 17 cm / 6 3/4"  
TS.08.24.20 20 cm / 8"

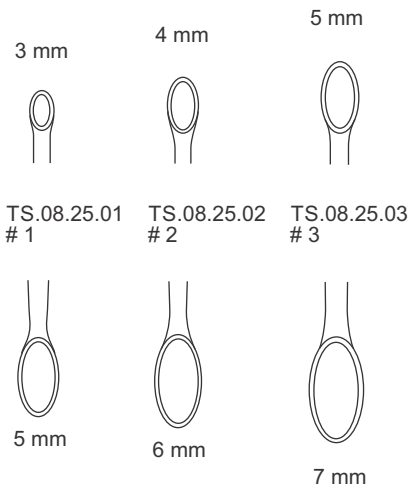

TS.08.25.01 # 1    TS.08.25.02 # 2    TS.08.25.03 # 3

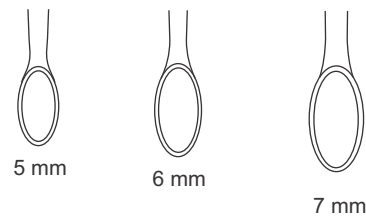

**VOLKMANN**  
22 cm / 8 3/4"



Orthopedic Instruments



# Orthopedic Instruments

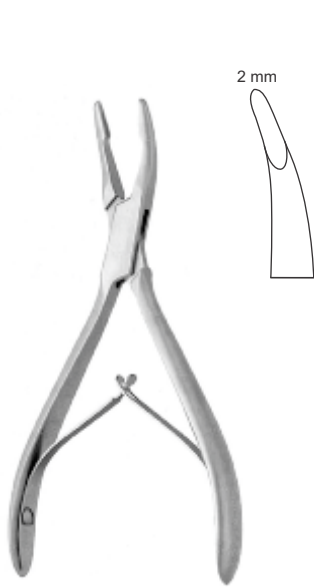

MINI-FRIEDMAN  
TS.08.01.12  
12 cm / 4¾"



FRIEDMANN  
TS.08.01.14  
14 cm / 5½"

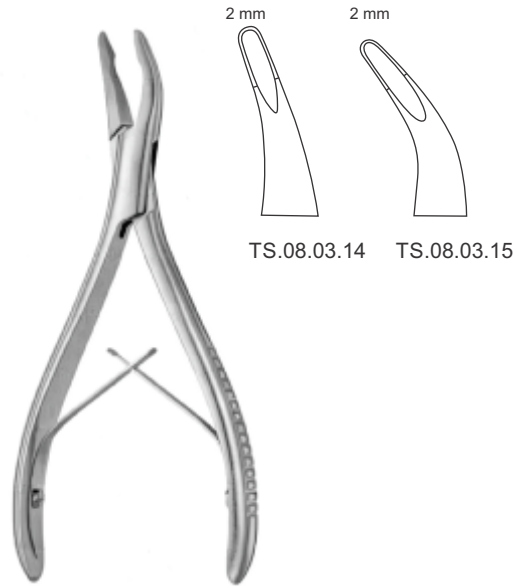

14 cm / 5½"

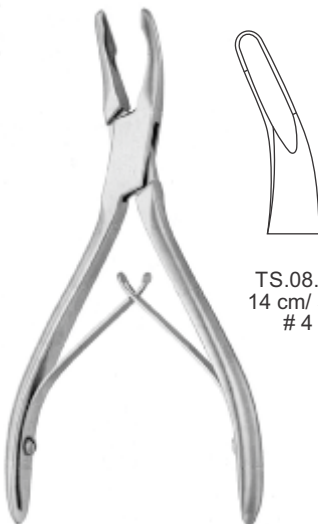

MEAD



TS.08.04.14  
14 cm / 5½"  
# 4



TS.08.04.16  
17 cm / 6¾"  
# 4A



TS.08.04.17  
17 cm / 6¾"



TS.08.05.18



TS.08.05.19

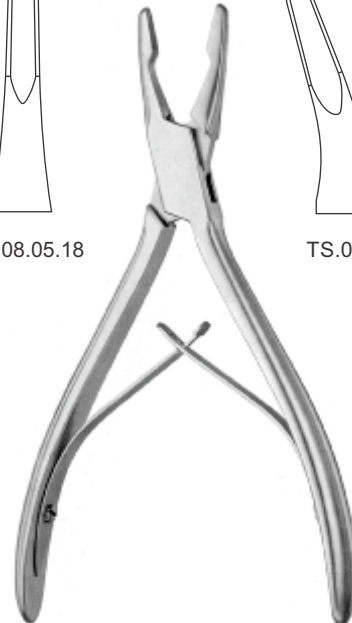

JANSEN  
17 cm / 6¾"

# Orthopedic Instruments

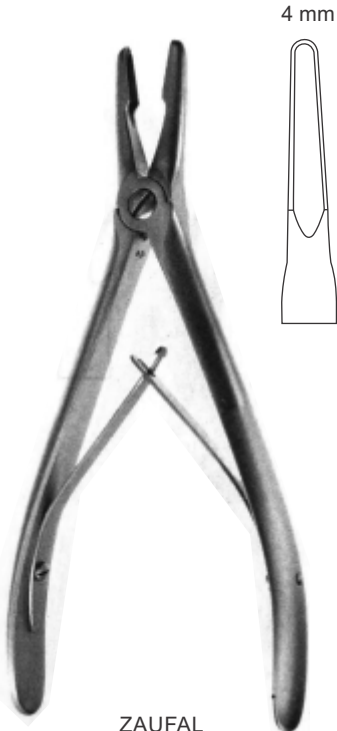

**ZAUFAL**  
 TS.08.06.68  
 18 cm / 7 1/8"



**BANE**  
 TS.08.07.18  
 18 cm / 7 1/8"



**HARTMANN**

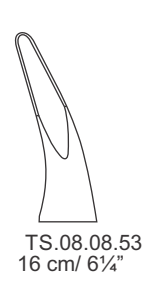

TS.08.08.53  
 16 cm / 6 1/4"

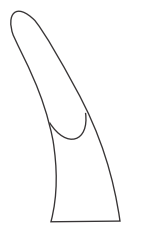

TS.08.08.56  
 19 cm / 7 1/2"



**OLIVECRONA**  
 TS.08.09.69  
 20 cm / 8"



**MEAD**



TS.08.10.14  
 14 cm / 5 1/2"  
 # 1



TS.08.10.17  
 17 cm / 6 3/4"  
 # 1A



**MEAD**

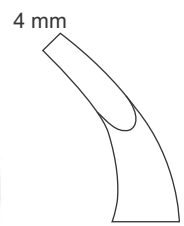

TS.08.11.87  
 17 cm / 6 3/4"

# Orthopedic Instruments



**SHELL**  
TS.08.12.97  
17 cm / 6<sup>3</sup>/<sub>4</sub>"



**BLUMENTHAL**  
16 cm / 6<sup>1</sup>/<sub>4</sub>"

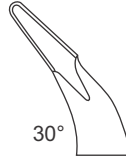

30°  
TS.08.13.30

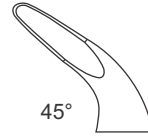

45°  
TS.08.14.45

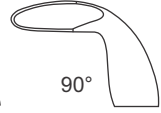

90°  
TS.08.15.90



**FISCH**

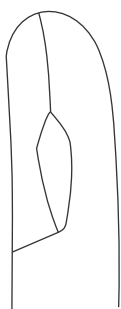

TS.08.16.12



TS.08.16.13



**ADSON**  
TS.08.17.21  
21 cm / 8<sup>1</sup>/<sub>4</sub>"





**BACON**  
 TS.08.18.70  
 20 cm / 8"



**BEYER**  
 17 cm / 6 3/4"

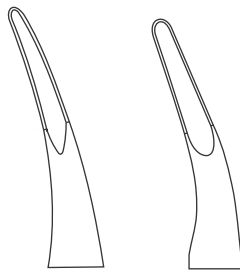

TS.08.19.02    TS.08.19.03



**LUER**  
 15 cm / 6"

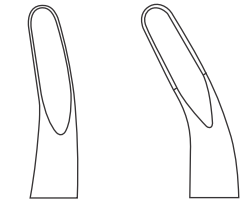

TS.08.20.15    TS.08.21.35



**LUER**  
 18 cm / 7 1/8"

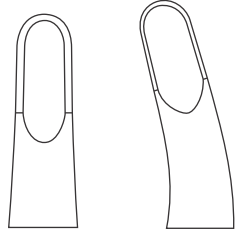

TS.08.22.17    TS.08.22.18



**LUER**  
 18 cm / 7 1/8"

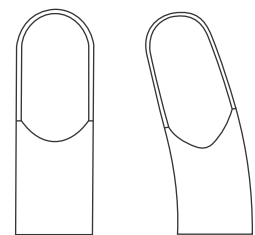

TS.08.23.18    TS.08.24.18

# Orthopedic Instruments



**KLEINERT-KUTZ**  
14 cm / 5½"

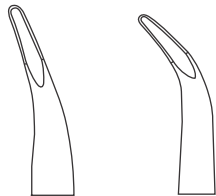

TS.08.25.13 TS.08.25.1



**STELLBRINK**  
17 cm / 6¾"

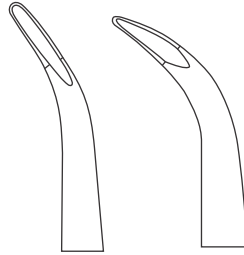

TS.08.26.17 TS.08.26.18



TS.08.26.35



**RUSKIN**  
24 cm / 9½"



TS.08.26.33



**RUSKIN**  
18 cm / 7½"

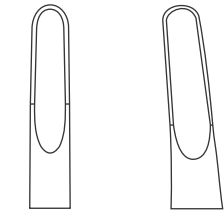

TS.08.26.45 TS.08.26.46



**SMITH-PETERSEN**  
23 cm / 9"



TS.08.27.24

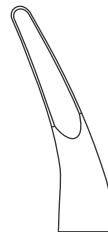

TS.08.28.24

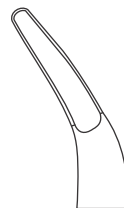

TS.08.29.24



**RUSKIN**  
 TS.08.35.28  
 18 cm / 7 1/8"

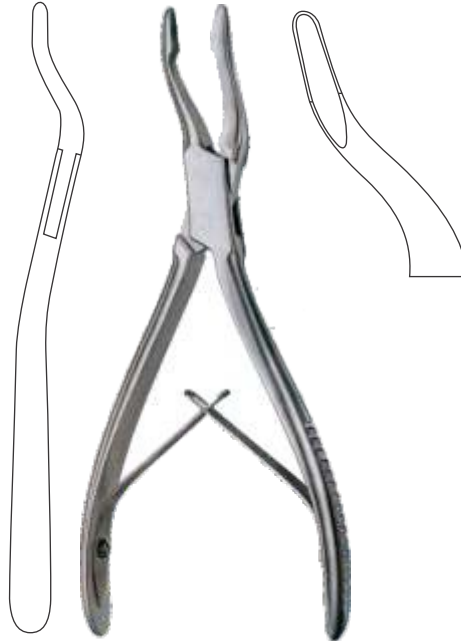

**JANSEN**  
 TS.08.36.17  
 17 cm / 6 3/4"

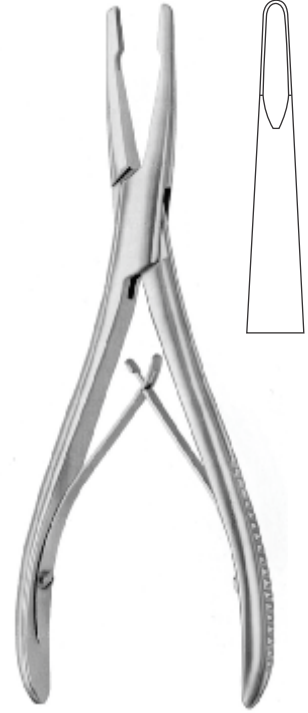

**DEFOURMENTEL**  
 TS.08.37.19  
 19 cm / 7 1/2"



TS.08.39.19



TS.08.38.19



**GEIGER**  
 TS.08.40.15  
 15 cm / 6"



**MARQUARDT**  
 TS.08.41.20  
 20 cm / 8"

# Orthopedic Instruments



PEIPER-BEYER  
TS.08.42.18  
4 mm, 18 cm / 7 1/8"



STILLE-LEKSELL  
TS.08.43.23  
23 cm / 9"



STILLE-LUER  
23 cm / 9"

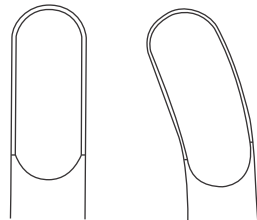

TS.08.44.23

TS.08.45.23



SAUERBRUCH-STILLE  
26 cm / 10 1/4"

20 mm

TS.08.46.26



**SAUERBRUCH-STILLE**  
 26 cm/ 10¼"

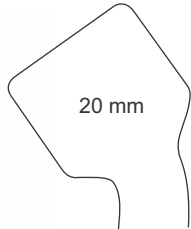

TS.08.47.26



**STILLE**  
 TS.08.48.23  
 23 cm/ 9"

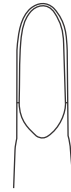

**LEKSELL**  
 23 cm/ 9"

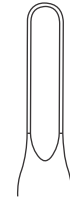

TS.08.49.05

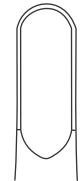

TS.08.49.08

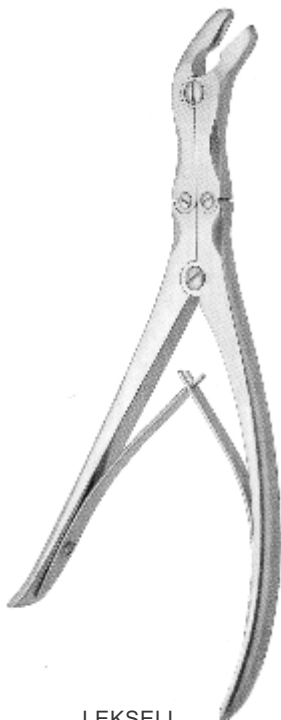

**LEKSELL**  
 23 cm/ 9"

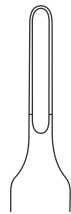

TS.08.50.03

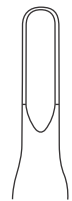

TS.08.50.05

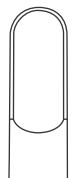

TS.08.50.08



**ECHLIN**  
 23 cm/ 9"

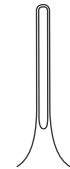

TS.08.51.02

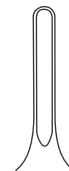

TS.08.51.03

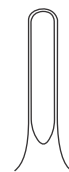

TS.08.51.04



# Orthopedic Instruments

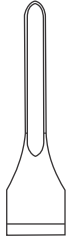

TS.08.51.53

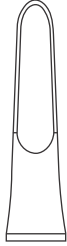

TS.08.51.54

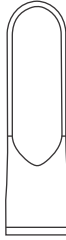

TS.08.51.58

LEKSELL  
36 cm / 14 1/2"

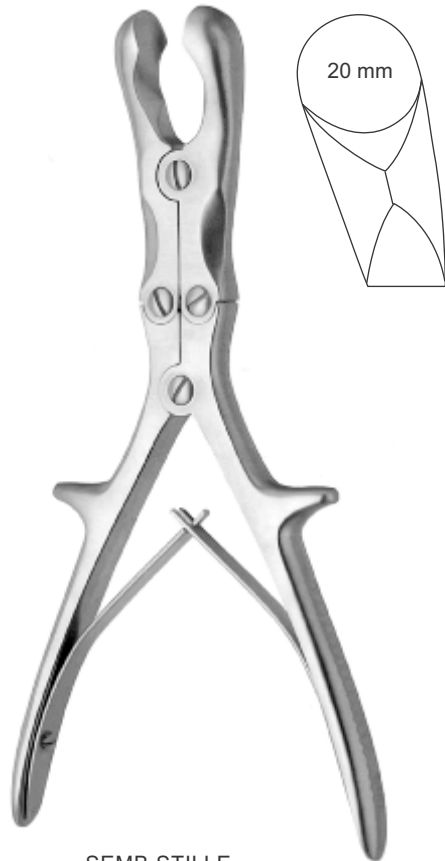

**SEMB-STILLE**  
 TS.08.52.23 23 cm/ 9"  
 TS.08.52.27 27 cm/ 10¾"



**RUSKIN**  
 TS.08.56.18  
 18 cm/ 7¼"



**STILLE-RUSKIN**  
 TS.08.58.24  
 24 cm/ 9½"

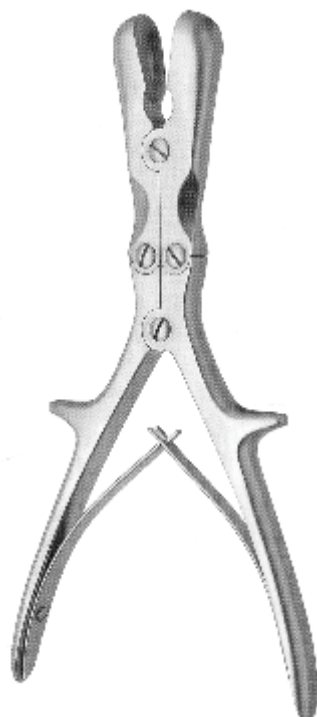

**STILLE-LUER**

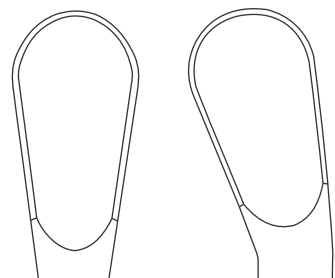

TS.08.60.23  
 23 cm/ 9"

TS.08.61.23  
 23 cm/ 9"

TS.08.60.27  
 27 cm/ 10¾"

TS.08.61.27  
 27 cm/ 10¾"



Retractors

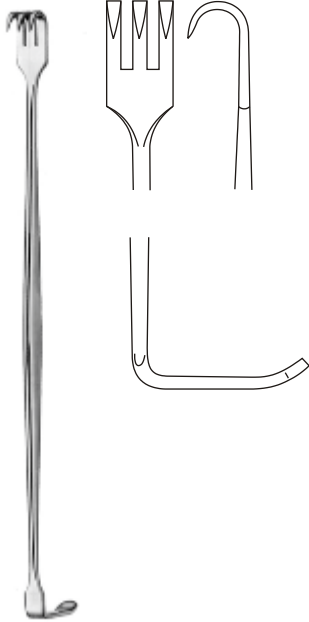

**SENN-MILLER**  
TS.08.01.16  
16 cm/ 6¼"

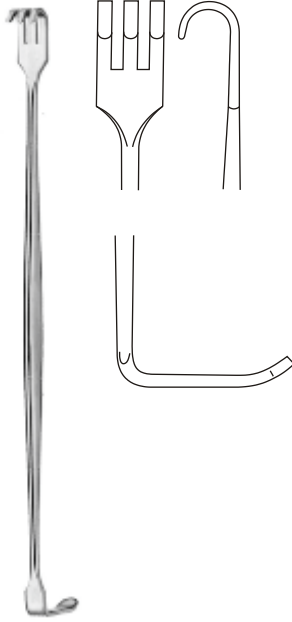

**SENN-MILLER**  
TS.08.02.16  
16 cm/ 6¼"

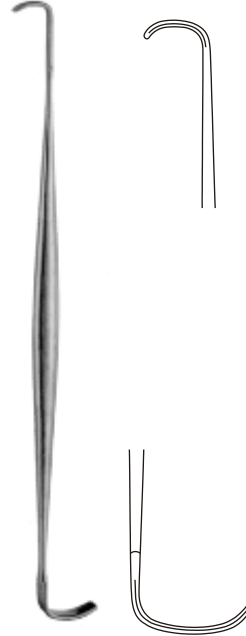

**RAGNELL**  
TS.08.05.16  
16 cm/ 6¼"



**COPE**  
TS.08.05.18  
18 cm/ 7⅞"



**CUSHING**

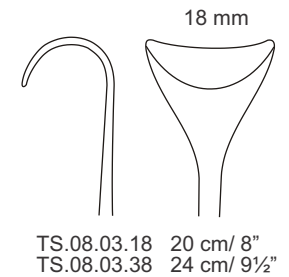
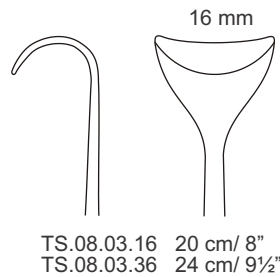
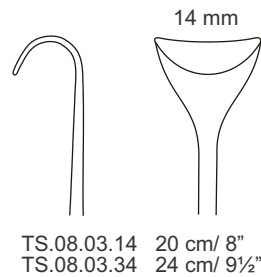
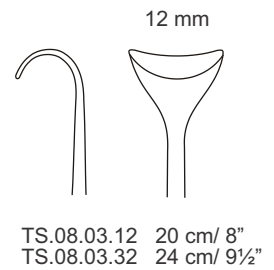
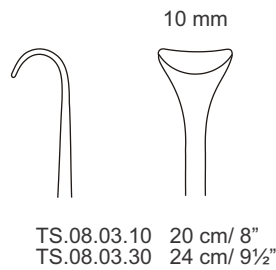
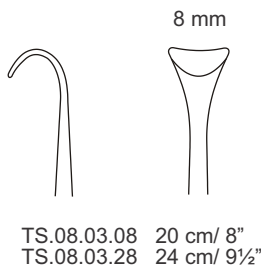

Vein retractors

# Orthopedic Instruments

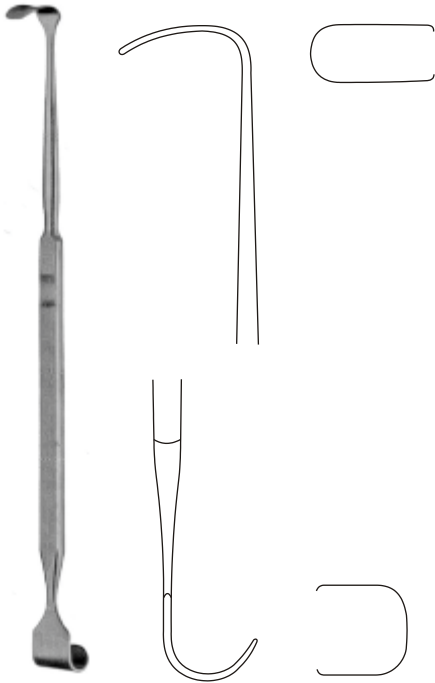

LUKENS  
TS.08.07.17  
17 cm/ 6¾"



JACKSON  
TS.08.07.27  
17 cm/ 6¾"

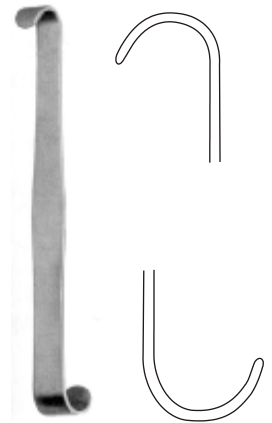

LUER  
TS.08.07.31  
11 cm/ 4¾"

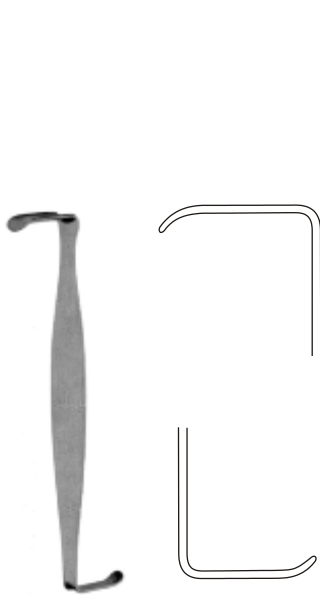

CRILE  
TS.08.07.41  
11 cm/ 4¾"

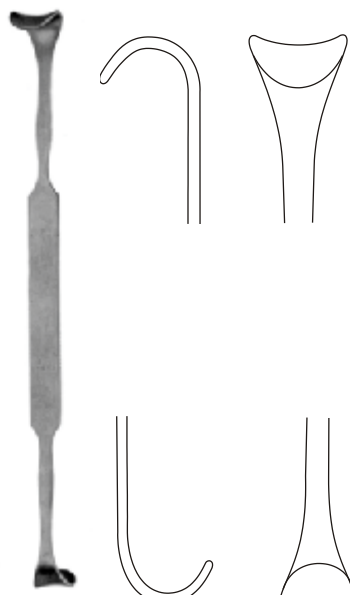

ROSE  
TS.08.07.46  
16 cm/ 6¼"

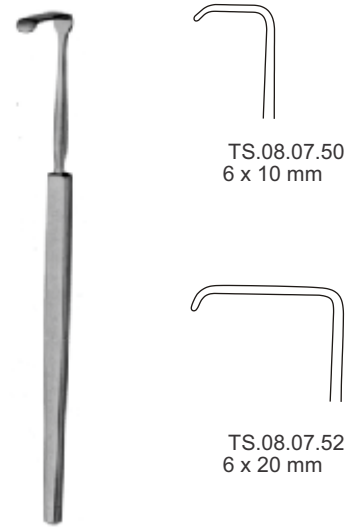

SENN-GREEN  
14 cm/ 5½"

TS.08.07.50  
6 x 10 mm

TS.08.07.52  
6 x 20 mm



3 x 15 mm

TS.08.07.58  
18 cm / 7 1/8"



TS.08.07.65  
6 X 25 mm

TS.08.07.66  
8 X 25 mm

LANGENBECK-GREEN  
17 cm / 6 3/4"



6 x 15 mm

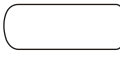

TS.08.07.75  
17 cm / 6 3/4"

6 x 18 mm



TS.08.07.85  
19 cm / 7 1/2"

STRANDELL-STILLE



1/1



TS.08.08.01  
sharp

TS.08.08.02  
blunt

GRAEFE  
16 cm / 6 1/4"



1/1



TS.08.09.02

16 cm / 6 1/4"



ADSON  
20 cm / 8"



TS.08.08.20  
3 mm



TS.08.09.20  
3 mm



CRILE  
TS.08.10.20  
20 cm / 8"



FRAZIER  
TS.08.11.12  
12.5 cm / 5"



GILLIES  
19 cm / 7 1/2"



TS.08.12.19



TS.08.12.20

# Orthopedic Instruments

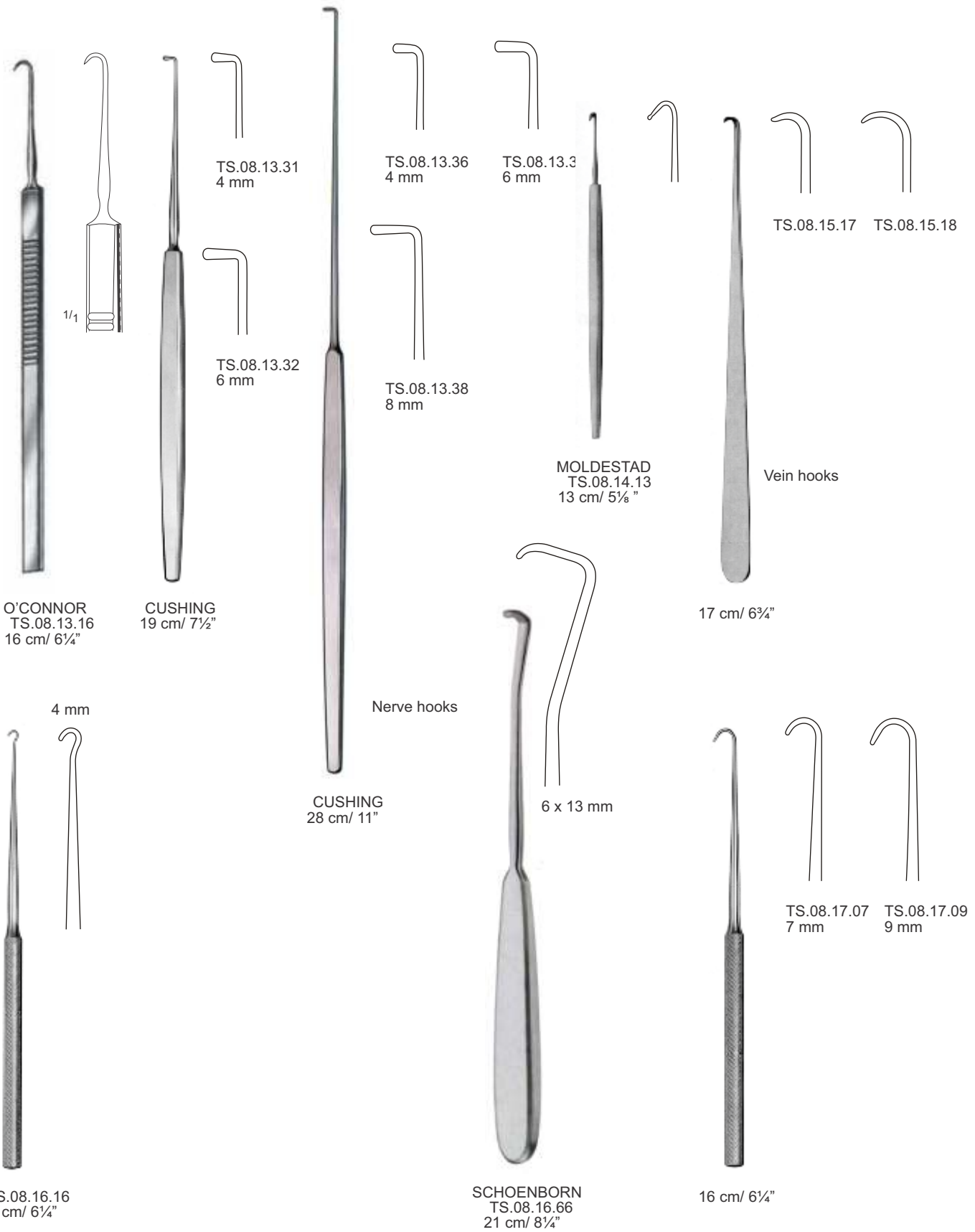

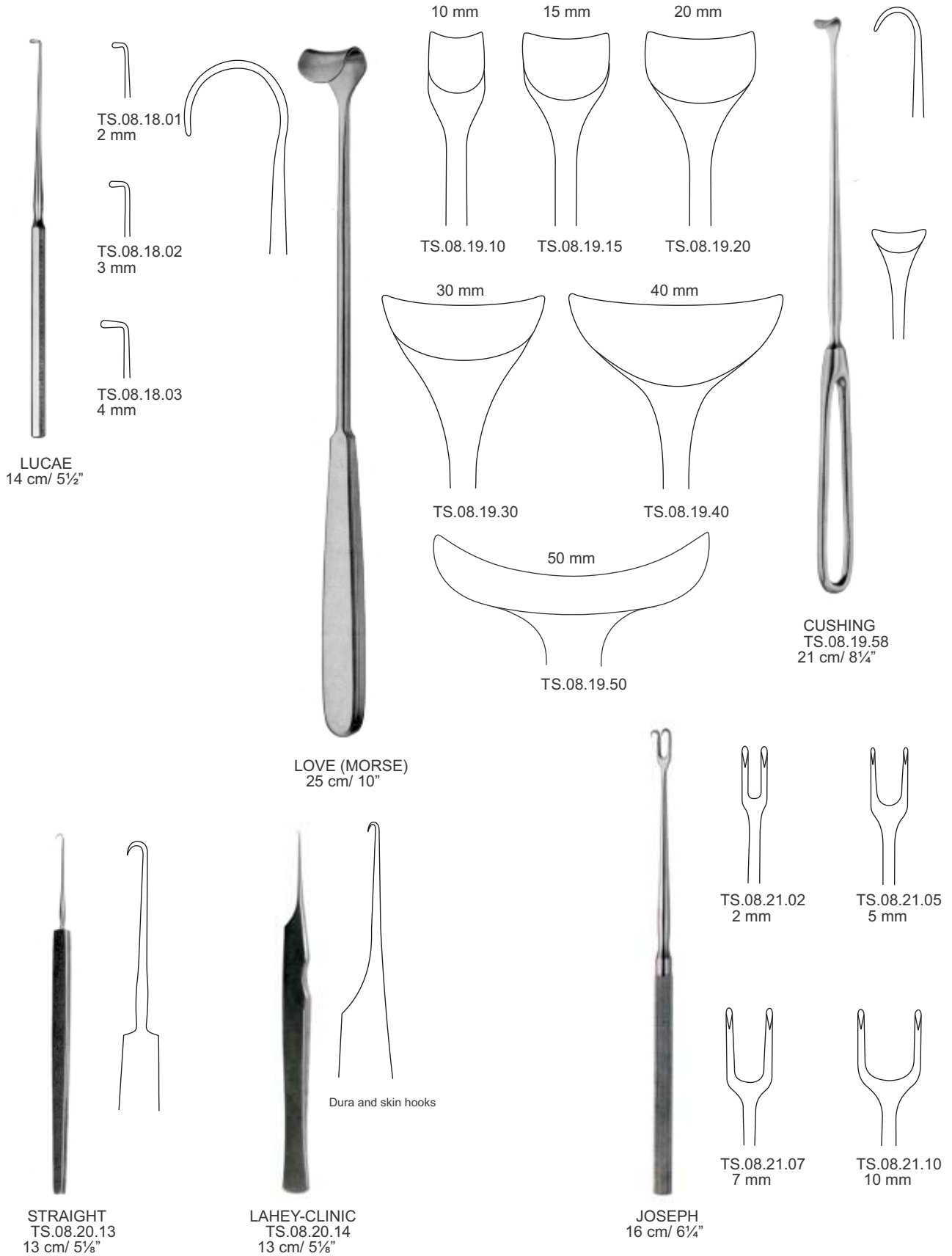



# Orthopedic Instruments

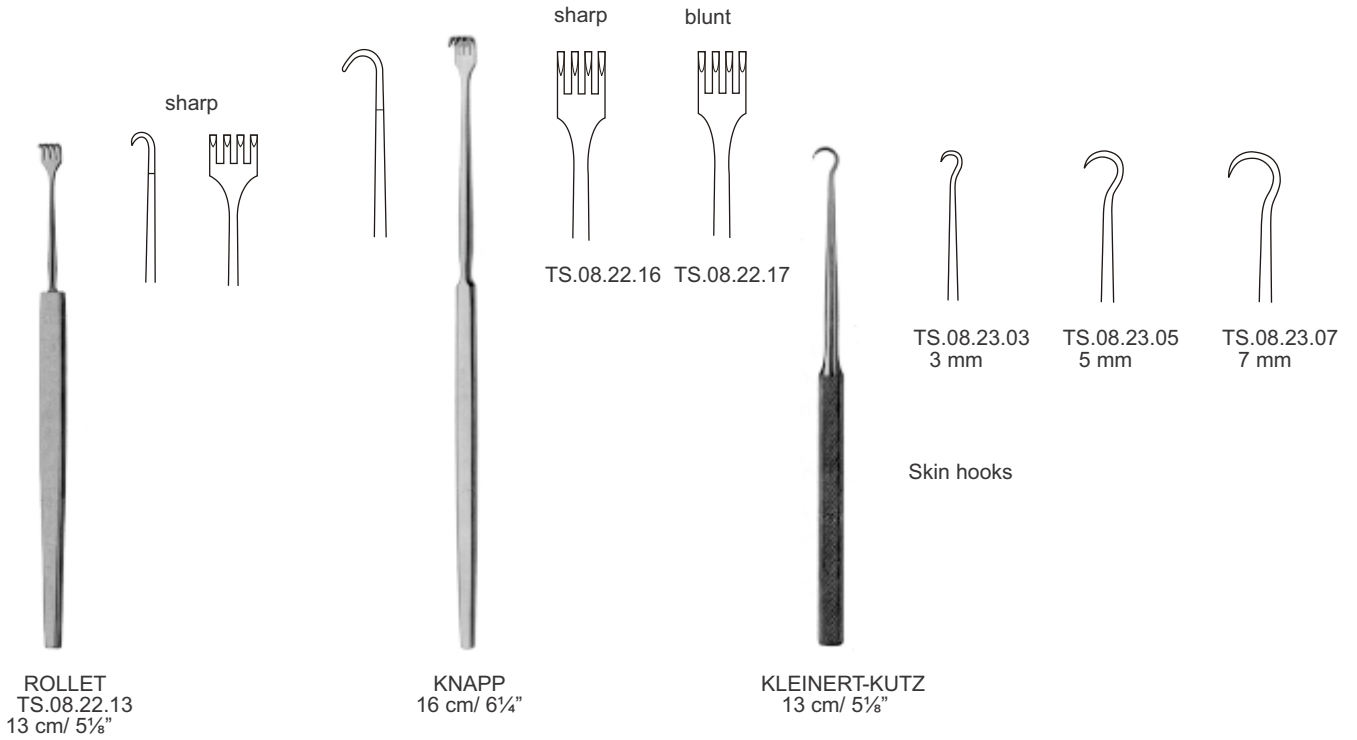

Skin hooks

Tracheal hooks

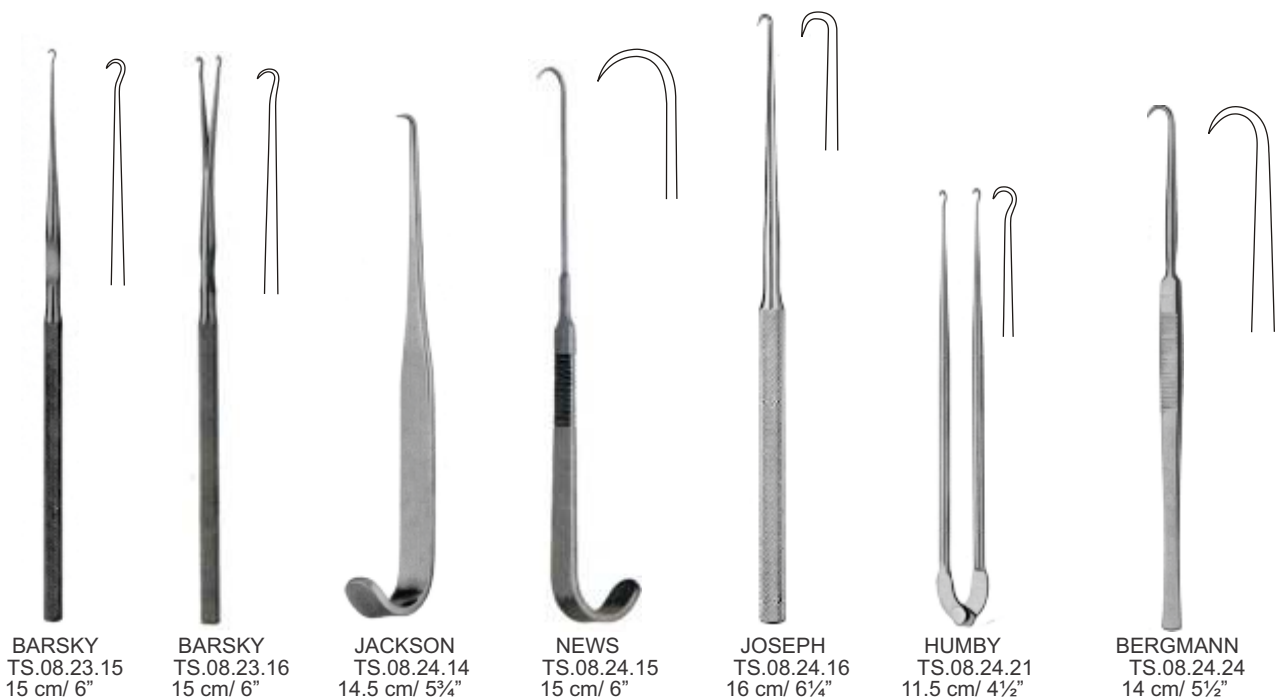



TS.08.24.26  
16.5 cm / 6½"



COTTLE  
TS.08.24.36  
16 cm / 6¼"



Fistula hook

EMMET  
TS.08.24.42  
22 cm / 8¾"



BENICKE  
19 cm / 7½"



TS.08.24.50  
sharp



TS.08.24.51  
blunt

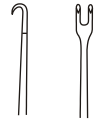

TS.08.25.13  
1.5 mm

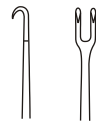

TS.08.25.23  
2 mm



GUTHRIE  
13 cm / 5¼"



FREER  
TS.08.25.15  
15 cm / 6"



GUTHRIE  
16 cm / 6¼"

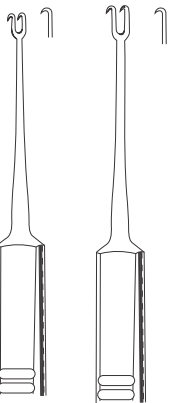

TS.08.25.16 TS.08.25.26



TS.08.26.16  
16 cm / 6¼"

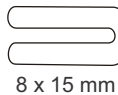

8 x 15 mm



FORK  
TS.08.26.36  
16 cm / 6¼"

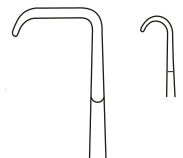

TS.08.26.42  
6 x 12 mm

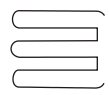

TS.08.26.43  
11 x 12 mm



16 cm / 6¼"

# Orthopedic Instruments

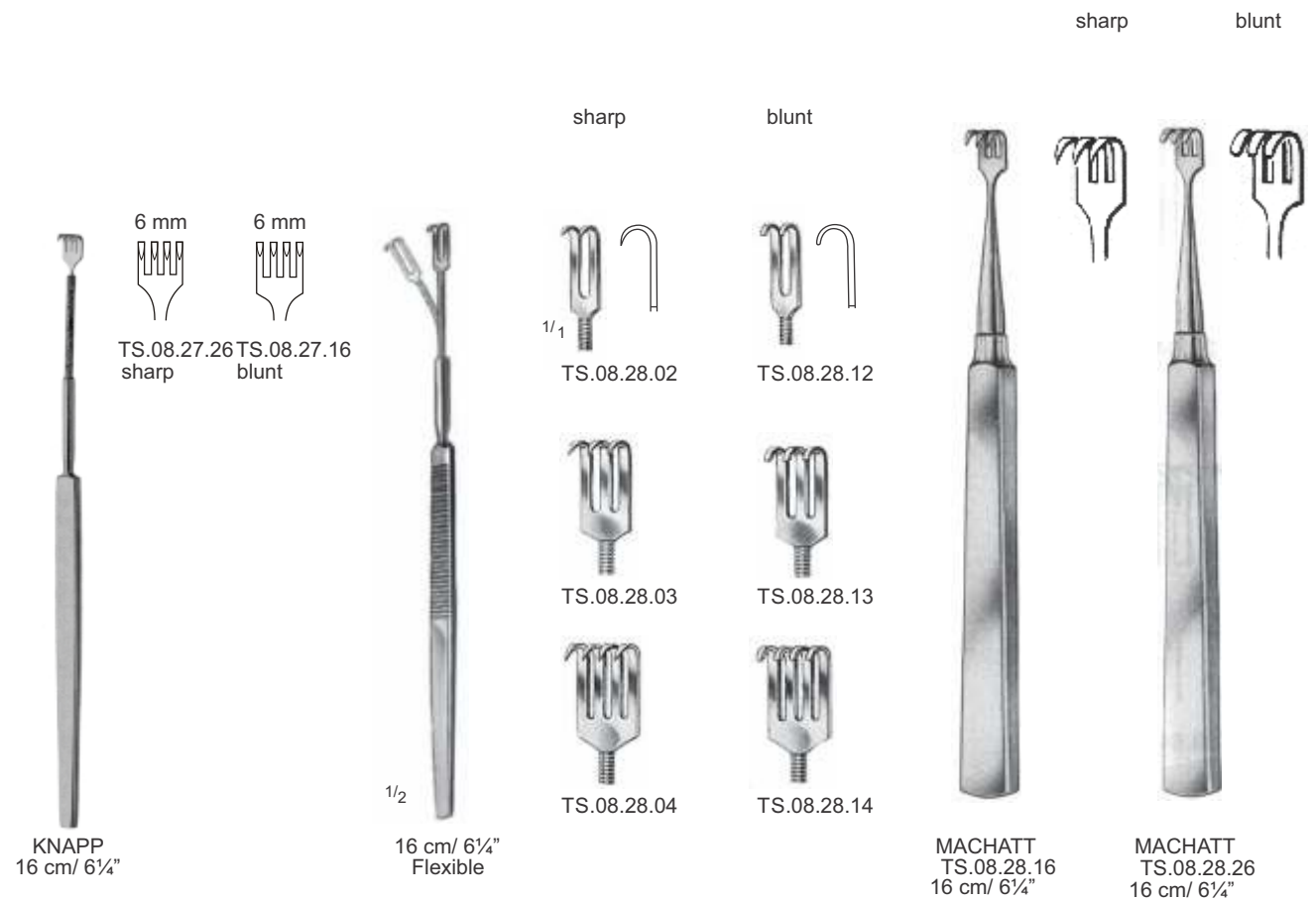
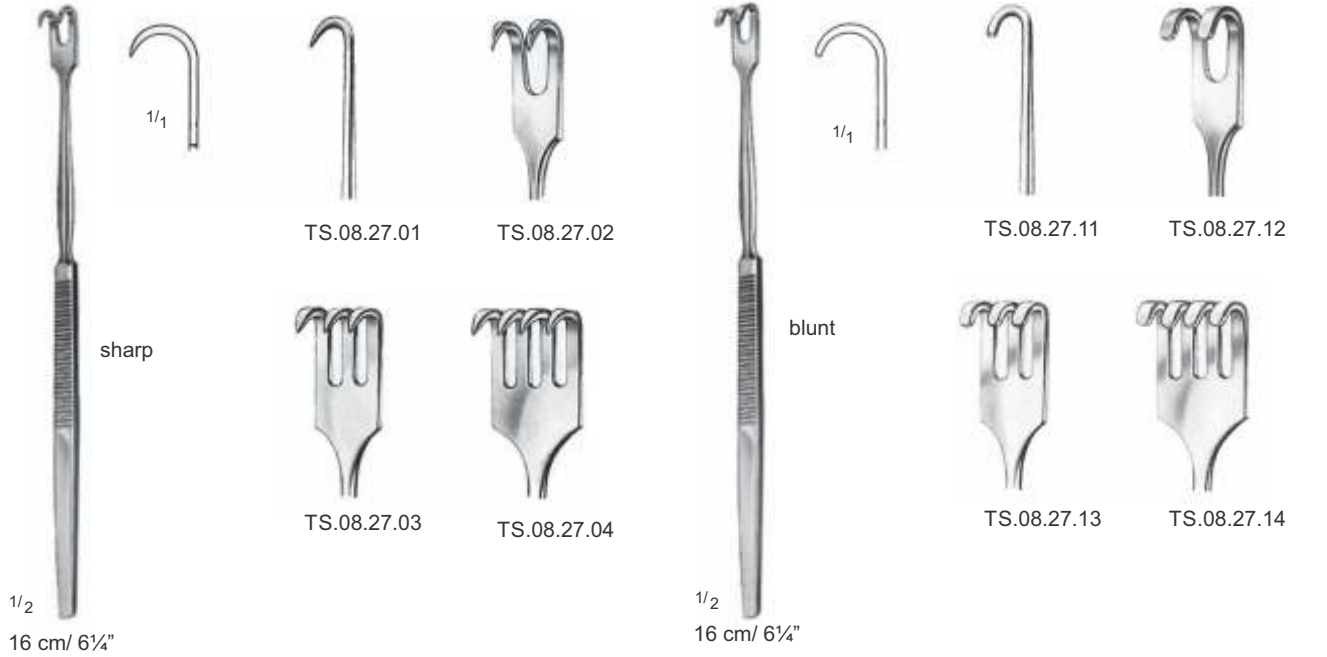

6 mm

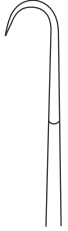

sharp



17 cm / 6<sup>3</sup>/<sub>4</sub>"

TS.08.29.01



5 mm



TS.08.29.02

8 mm



TS.08.29.03

11 mm



TS.08.29.04

6 mm



blunt



17 cm / 6<sup>3</sup>/<sub>4</sub>"

TS.08.30.01



TS.08.30.02

8 mm



TS.08.30.03

11 mm



TS.08.30.04

9 mm



16 cm / 6<sup>1</sup>/<sub>4</sub>"

TS.08.31.01



8 mm



TS.08.31.02

10 mm

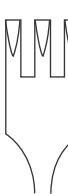

TS.08.31.03

14 mm



TS.08.31.04

9 mm



16 cm / 6<sup>1</sup>/<sub>4</sub>"

TS.08.31.11



8 mm



TS.08.31.12

10 mm



TS.08.31.13

14 mm



TS.08.31.14

2 mm

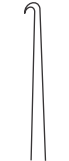

LAHEY CLINIC  
TS.08.31.15  
13 cm / 5<sup>1</sup>/<sub>8</sub>"

# Orthopedic Instruments

7 mm

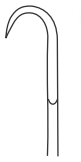

sharp

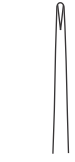

TS.08.31.21

5 mm



TS.08.31.22

7 mm

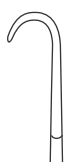

blunt



TS.08.31.31



TS.08.31.32

5 mm

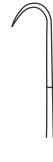

8 mm



TS.08.31.33

11 mm

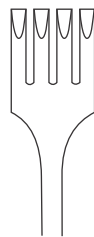

TS.08.31.34

4 mm



TS.08.32.62

5 mm



7 mm



TS.08.32.63

4 mm



TS.08.33.62

7 mm

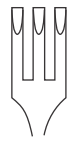

TS.08.33.63

16 cm / 6 1/4"

16 cm / 6 1/4"

16 cm / 6 1/4"

16 cm / 6 1/4"

with flexible shaft



MINI-LANGENBECK  
16cm / 6 1/4"



TS.08.32.10  
10 x 6 mm

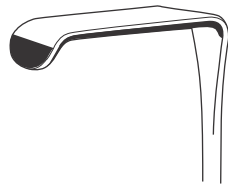

TS.08.32.11  
17 x 5 mm

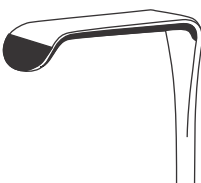

TS.08.32.20  
20 x 6 mm

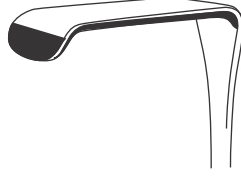

TS.08.32.21  
22 x 8 mm



MEYERDING  
18cm / 7 1/8"

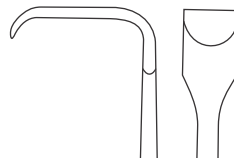

TS.08.33.01  
7 x 18 mm

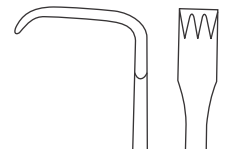

TS.08.33.02  
5 x 16 mm

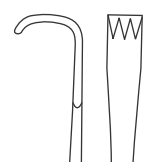

TS.08.33.03  
4 x 7 mm

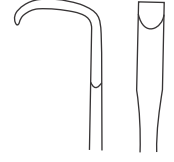

TS.08.33.04  
3 x 10 mm

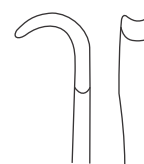

TS.08.33.05  
4 x 7 mm

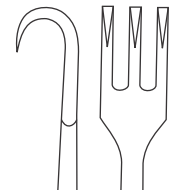

TS.08.33.06  
4 x 10 mm

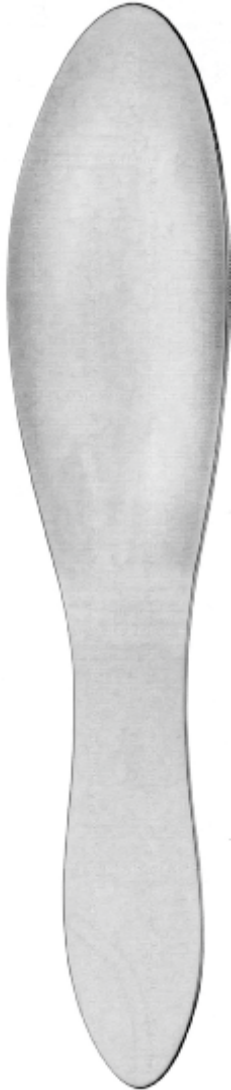

REVERDIN  
TS.08.35.29  
45/60 x 290 mm



REVERDIN  
TS.08.36.28  
5/60 x 290 mm



RIBBON  
47 cm - 18½"

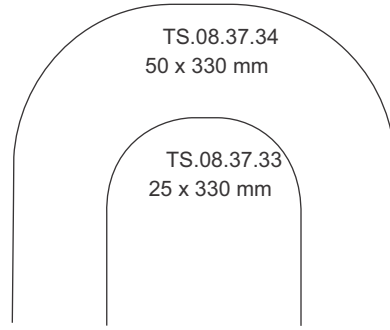

TS.08.37.34  
50 x 330 mm

TS.08.37.33  
25 x 330 mm

stainless

flexible



malleable

TUFFIER  
TS.08.39.20  
17/25 x 200 mm



HABERER  
TS.08.40.20  
20 cm / 8", 17/25 mm  
TS.08.40.28  
28 cm / 11", 25/30 mm  
TS.08.40.30  
30 cm / 12", 37/45 x 300 mm

stainless



TS.08.38.30 30 x 330 mm  
TS.08.38.40 40 x 330 mm  
TS.08.38.50 50 x 330 mm  
TS.08.38.60 75 x 330 mm

malleable



malleable

FIMZ  
TS.08.41.05 15 x 200 mm  
TS.08.41.06 6 x 200 mm  
TS.08.41.10 10 x 200 mm  
TS.08.41.12 12 x 200 mm  
TS.08.41.17 17 x 200 mm  
TS.08.41.20 20 x 200 mm



COLLIN  
TS.08.41.15  
16.5 cm/ 6½"



malleable

TS.08.41.55 27 x 250 mm  
TS.08.41.65 35 x 250 mm



MAYO-COLLIN  
TS.08.42.15  
15 cm / 6"



PARKER  
TS.08.43.18  
18 cm / 7<sup>1</sup>/<sub>8</sub>"

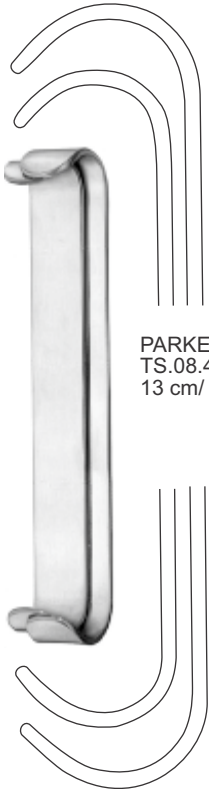

PARKER  
TS.08.43.13  
13 cm / 5<sup>1</sup>/<sub>2</sub>"



PARKER-MOTT  
TS.08.43.26  
16.5 cm / 6<sup>1</sup>/<sub>2</sub>"



# Orthopedic Instruments

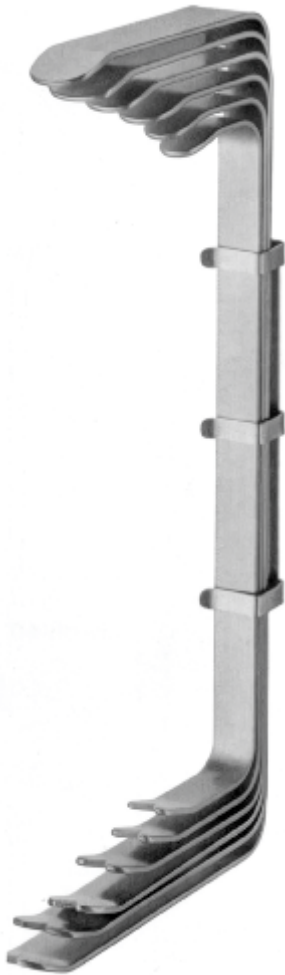

SOFIELD  
TS.08.44.50  
Set complete

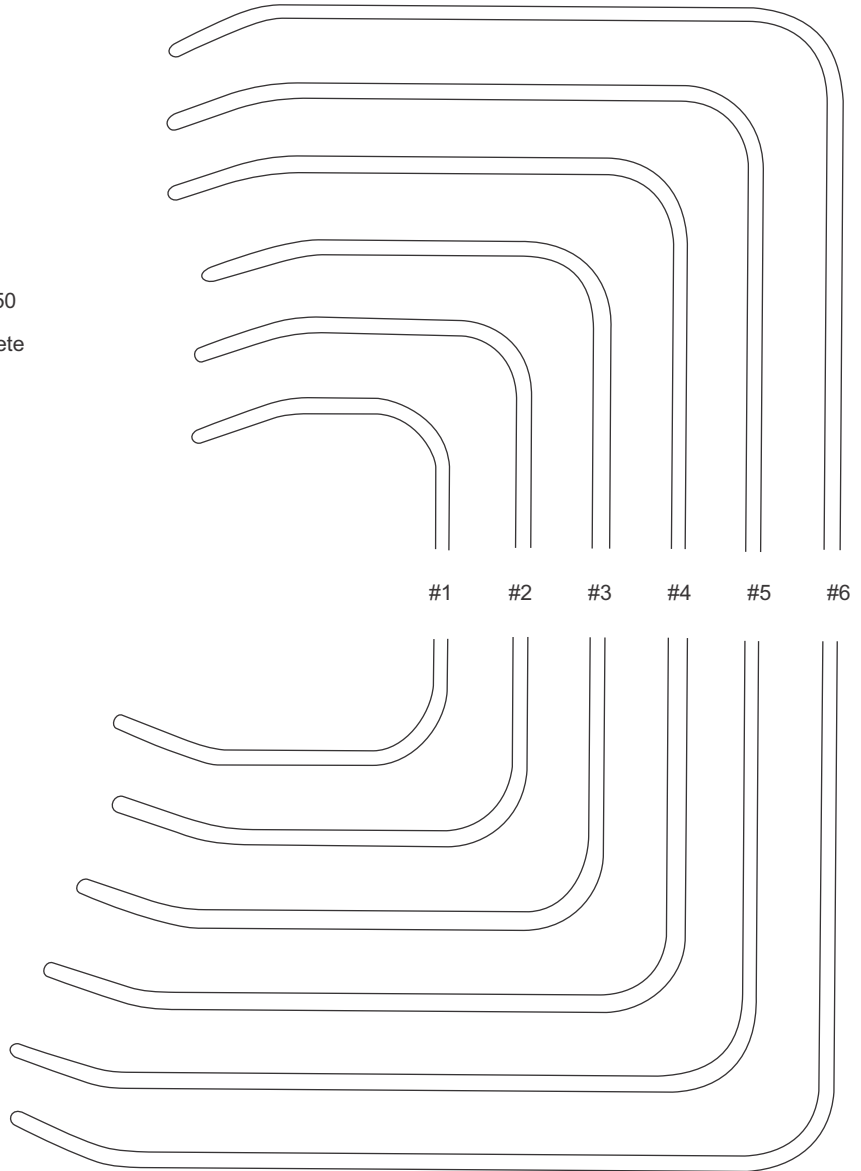

TS.08.44.59

## SOFIELD

TS.08.44.51	# 1	18 cm/ 7 <sup>1</sup> / <sub>6</sub> "	13 x 45 mm/ 13 x 35 mm
TS.08.44.52	# 2	19 cm/ 7 <sup>1</sup> / <sub>2</sub> "	13 x 55 mm/ 16 x 45 mm
TS.08.44.53	# 3	20 cm/ 8"	16 x 70 mm/ 16 x 55 mm
TS.08.44.54	# 4	21 cm/ 8 <sup>1</sup> / <sub>4</sub> "	16 x 85 mm/ 16 x 70 mm
TS.08.44.55	# 5	22 cm/ 8 <sup>3</sup> / <sub>4</sub> "	19 x 100 mm/ 19 x 80 mm
TS.08.44.56	# 6	23 cm/ 9"	19 x 110 mm/ 19 x 90 mm

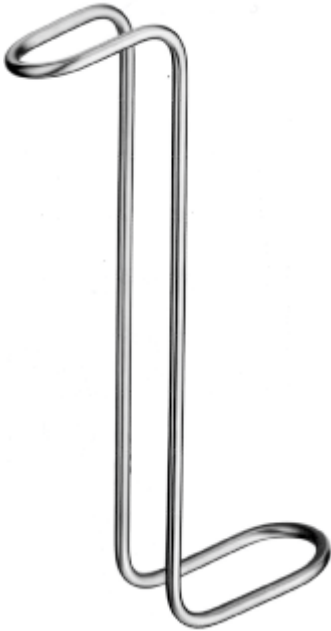

**COLLIN-HARTMANN**  
 TS.08.45.16  
 16 cm/ 6¼"

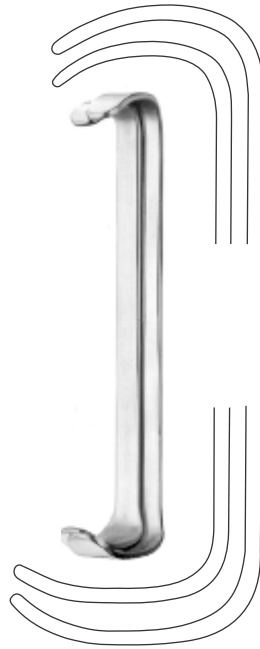

**FARABEUFBABY**  
 TS.08.46.12  
 12 cm/ 4¾"

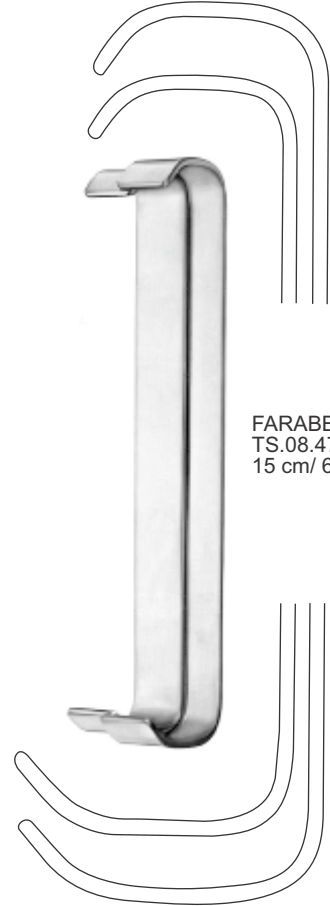

**FARABEUFB**  
 TS.08.47.15  
 15 cm/ 6"

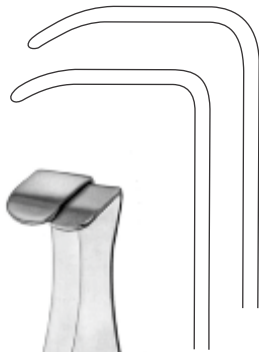

**PARKER-LANGENBECK**  
 (US-ARMY)  
 TS.08.48.21  
 21 cm/ 8¼"



**FACE**  
**RETRACTOR**  
 TS.08.50.21  
 11.5 cm 4½"

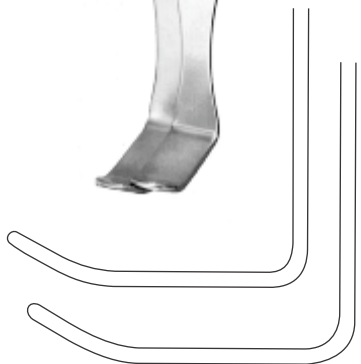

# Orthopedic Instruments

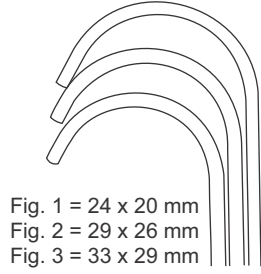

Fig. 1 = 24 x 20 mm  
Fig. 2 = 29 x 26 mm  
Fig. 3 = 33 x 29 mm

Fig. 1,2,3  
Fig. 1 = 30 x 28 mm  
Fig. 2 = 36 x 36 mm  
Fig. 3 = 38 x 43 mm

**ROUX**  
TS.08.49.01 Fig 1 = 15 cm/ 6"  
TS.08.49.02 Fig 2 = 16 cm/ 6¼"  
TS.08.49.03 Fig 3 = 17 cm/ 6¾"

**TS.08.49.10**  
Set complete



**FREEMAN**  
TS.08.50.11  
21.8 cm/ 8½"



**ROUX**  
TS.08.50.13  
13 cm/ 5½"

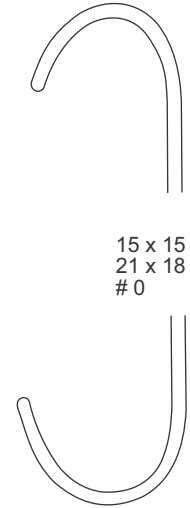

15 x 15 mm  
21 x 18 mm  
# 0



**ROUX "S"**  
TS.08.49.50  
Set complete

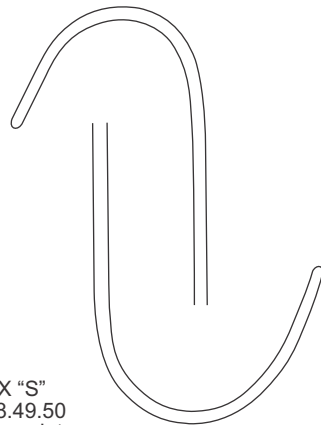

**TS.08.49.64**  
# 1  
14 cm/ 5½"  
22 x 20 mm  
28 x 25 mm



**TS.08.49.65**  
# 2  
15 cm/ 6"  
26 x 23 mm  
38 x 29 mm

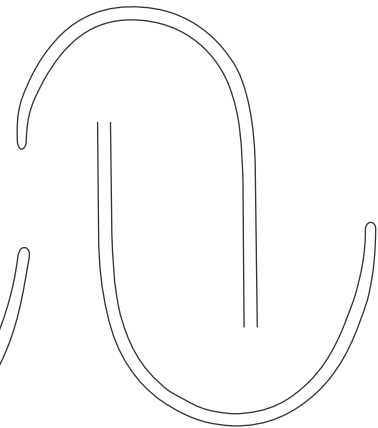

**TS.08.49.66**  
# 3  
16.5 cm/ 6½"  
29 x 29 mm  
44 x 34 mm



MATHIEU  
TS.08.51.20  
20 cm / 8"

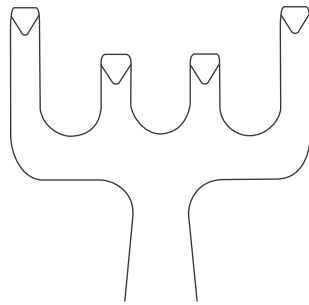

WALTER  
TS.08.51.39  
19 cm / 7½"



VOLKMANN  
12 cm / 4¾"

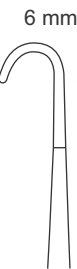

VOLKMANN  
12 cm / 4¾"

7 mm



TS.08.52.02

9 mm



TS.08.52.03

13 mm

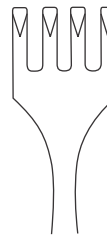

TS.08.52.04

18 mm

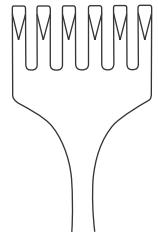

TS.08.52.06

7 mm



TS.08.53.02

9 mm



TS.08.53.03

13 mm

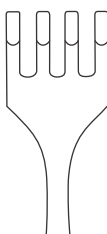

TS.08.53.04

18 mm

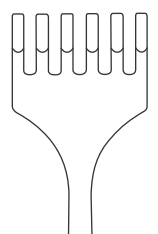

TS.08.53.06

# Orthopedic Instruments

10 mm

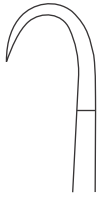

9 mm

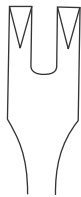

TS.08.54.02

13 mm

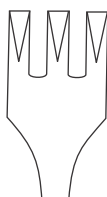

TS.08.54.03

15 mm



TS.08.55.20

18 mm

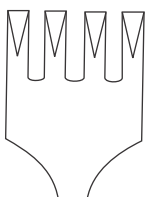

TS.08.54.04

28 mm

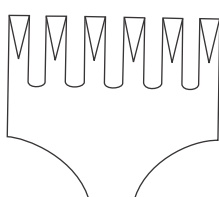

TS.08.54.06

15 mm

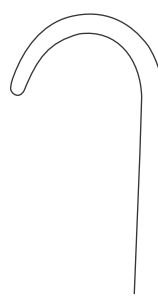

TS.08.55.21



**VOLKMANN**  
20 cm / 8"



**VOLKMANN**  
21 cm / 8¼"

10 mm

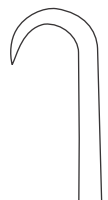

TS.08.55.28



**BONE HOOK**  
20.3 cm / 8"  
TS.08.55.30 sharp      TS.08.55.31 blunt

20 mm

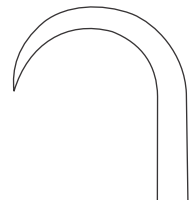

TS.08.55.29

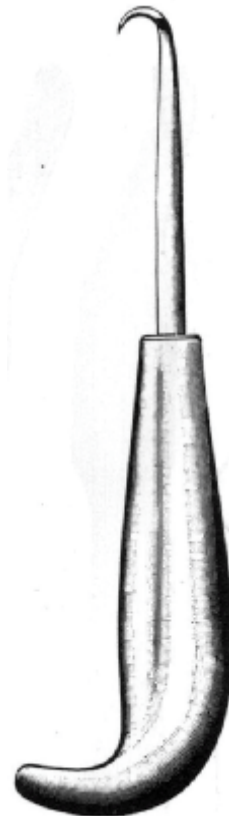

19 cm / 7½"

# Orthopedic Instruments



VOLKMANN  
 20 cm/ 8"

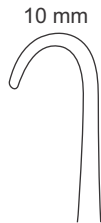

10 mm



9 mm

TS.08.56.02



13 mm

TS.08.56.03

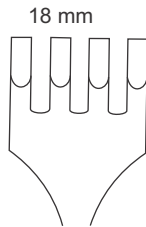

18 mm

TS.08.56.04

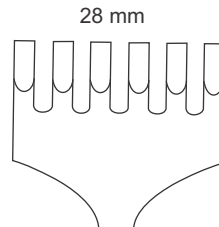

28 mm

TS.08.56.06



VOLKMANN  
 22 cm/ 8¾"

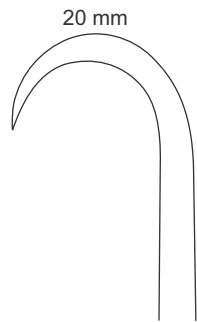

20 mm

TS.08.57.21

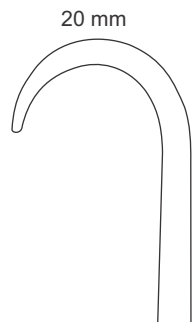

20 mm

TS.08.57.31

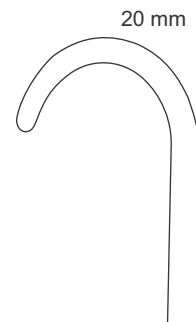

20 mm

TS.08.57.41

# Orthopedic Instruments

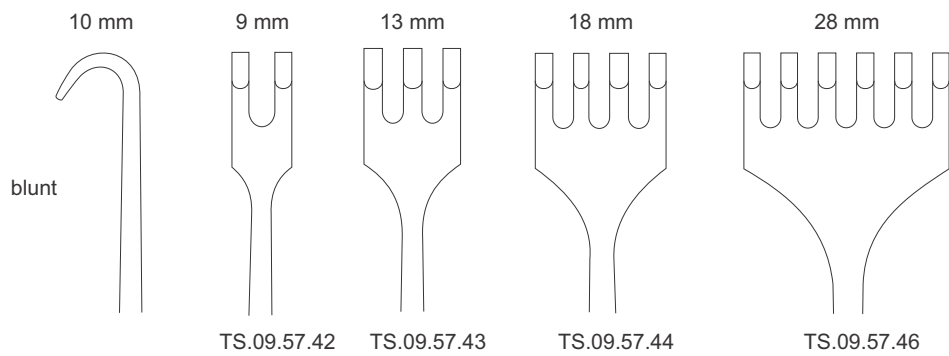
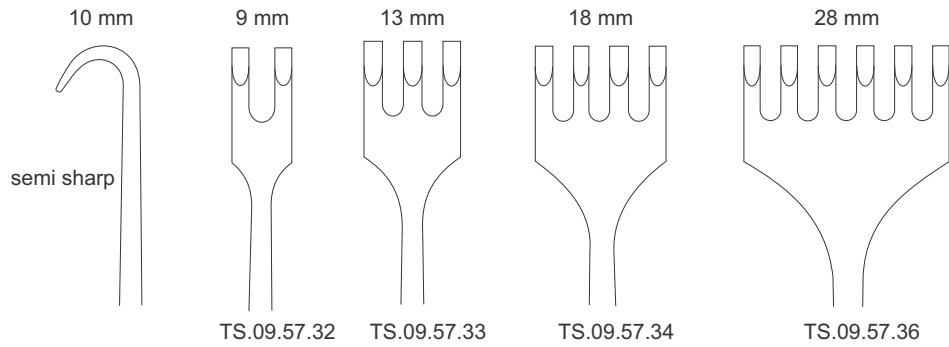
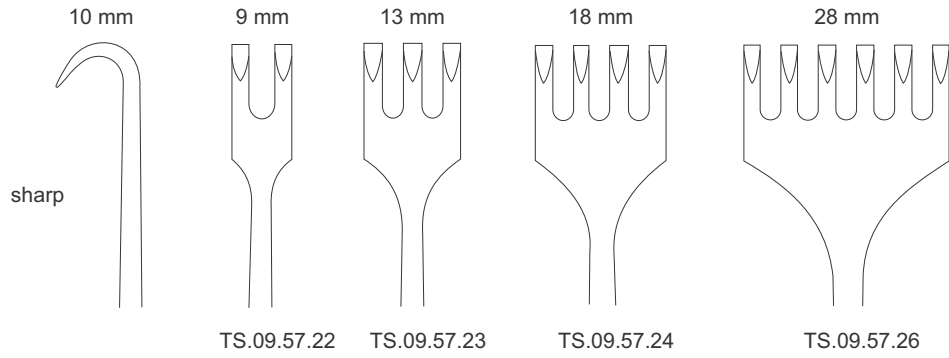

VOLKMANN  
22 cm / 8<sup>3</sup>/<sub>4</sub>"

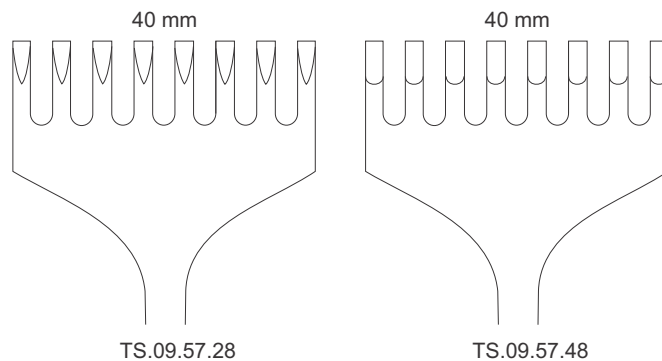

# Orthopedic Instruments



VOLKMANN  
 21 cm / 8¼"

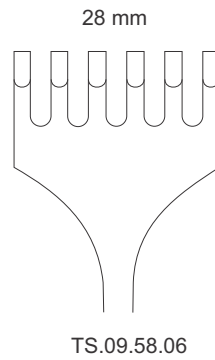
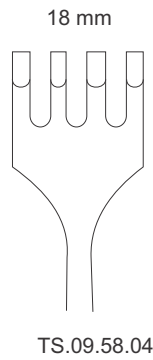
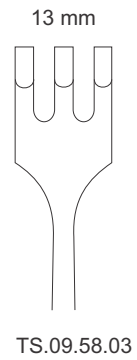
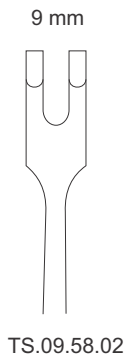

VOLKMANN  
 21 cm / 8¼"

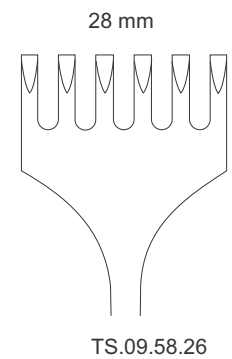
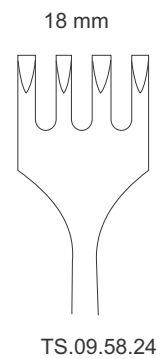
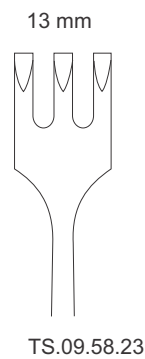
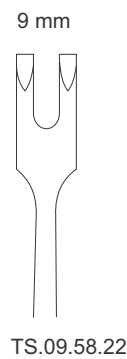
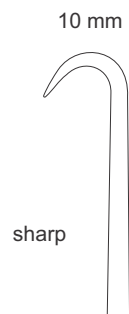



# Orthopedic Instruments

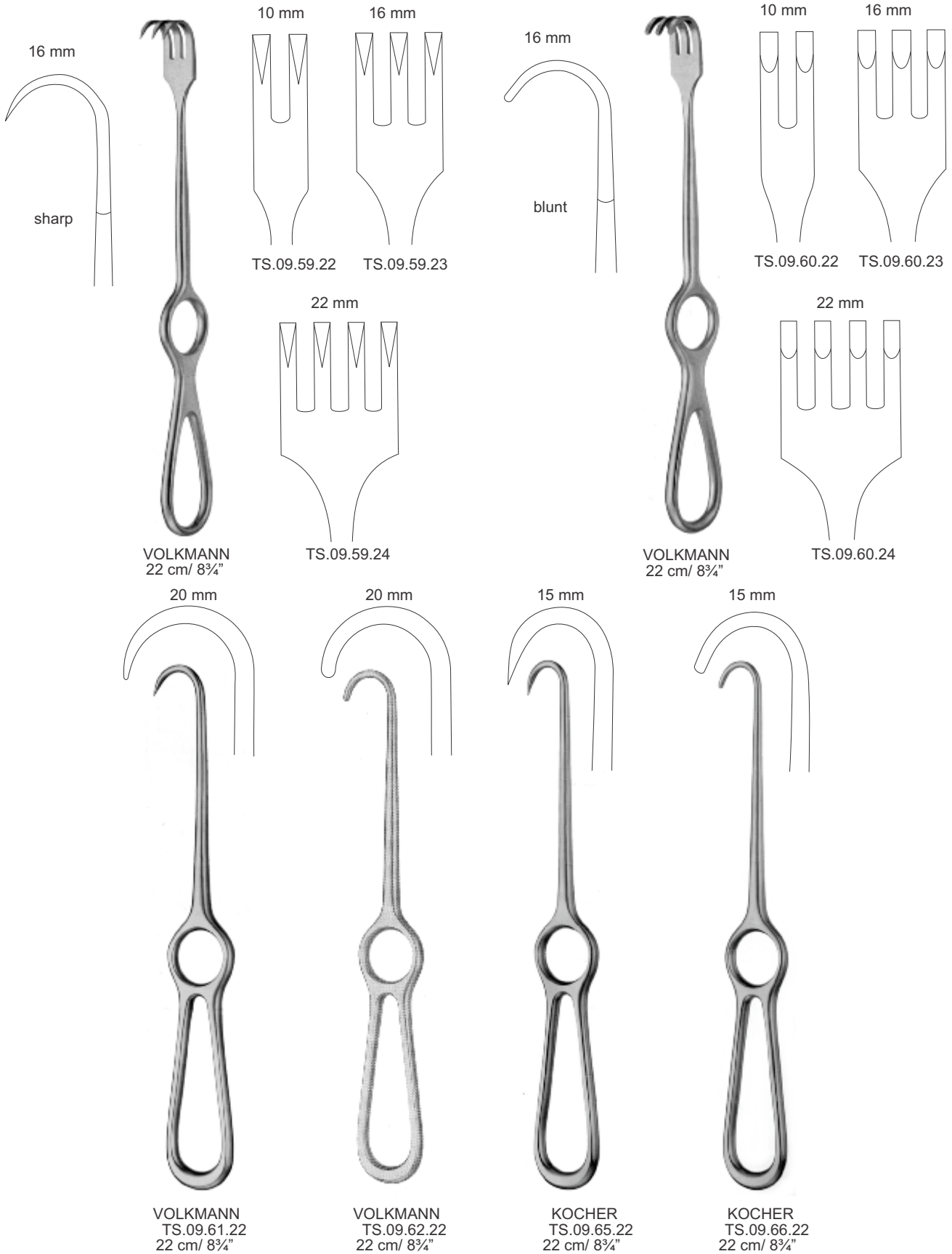

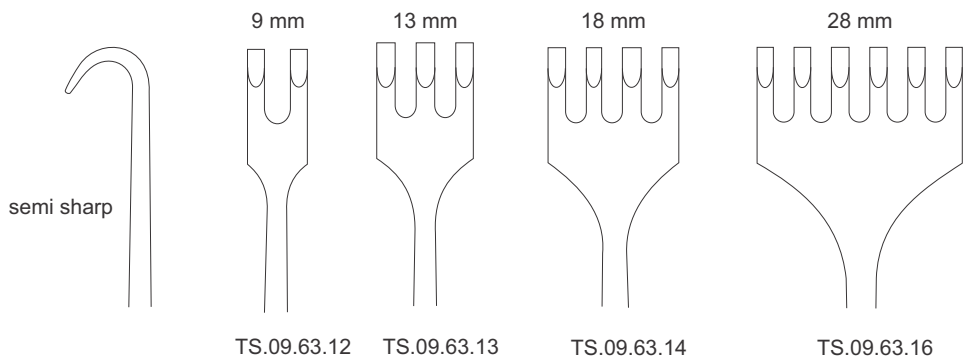
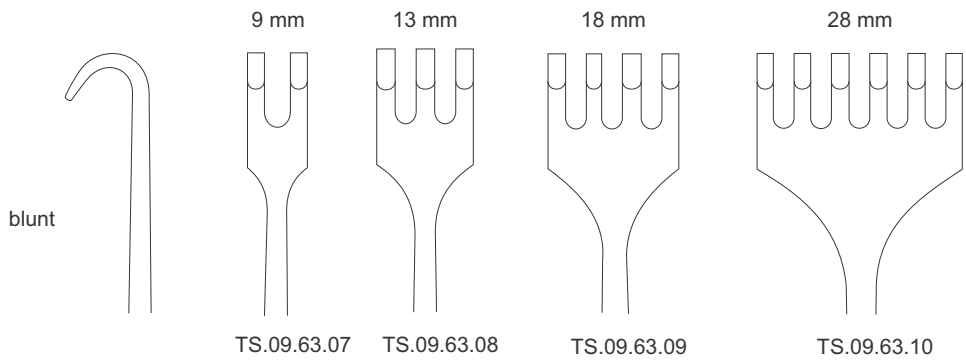
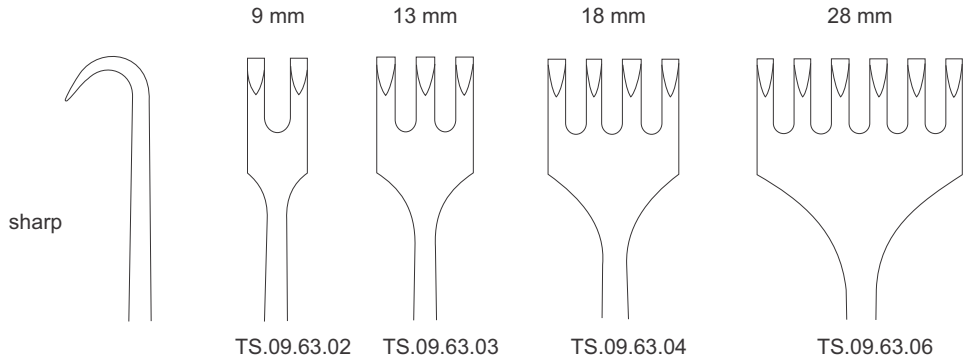

**VOLKMANN**  
 22 cm/ 8¾"

# Orthopedic Instruments

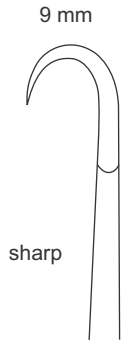

MURPHY  
19.5 cm / 7 3/4"

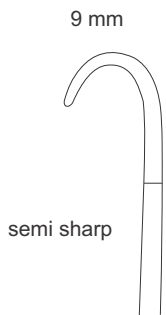
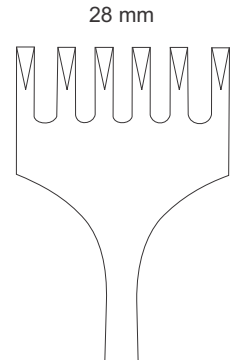
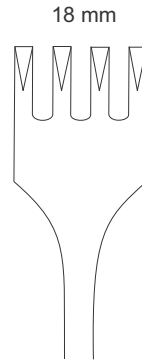
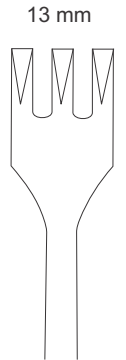
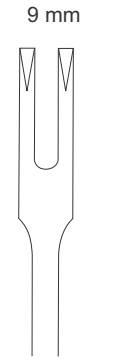

KOCHER  
22 cm / 8 3/4"

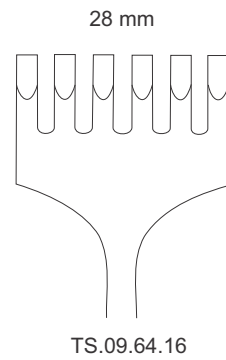
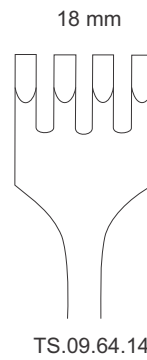
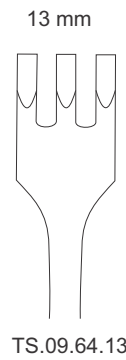
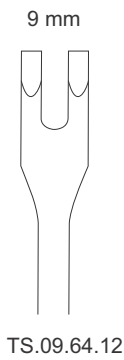



LANGENBECK  
 21 cm/ 8¼"

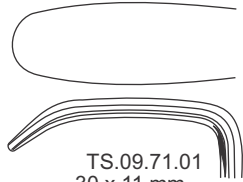

TS.09.71.01  
 30 x 11 mm

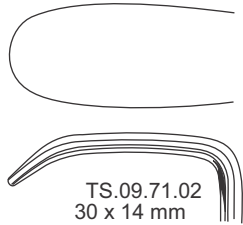

TS.09.71.02  
 30 x 14 mm

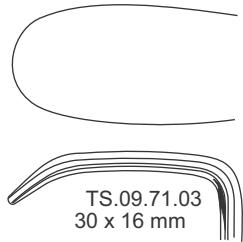

TS.09.71.03  
 30 x 16 mm

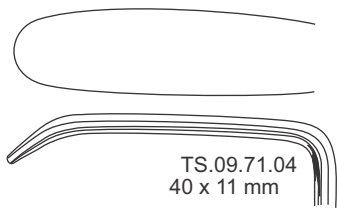

TS.09.71.04  
 40 x 11 mm

TS.09.72.04  
 40 x 11 mm

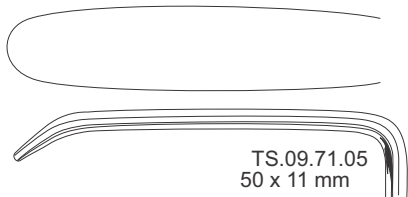

TS.09.71.05  
 50 x 11 mm



LANGENBECK  
 21 cm/ 8¼"

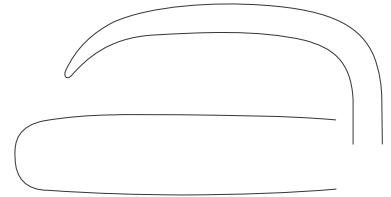

TS.09.71.10  
 10 x 40 mm

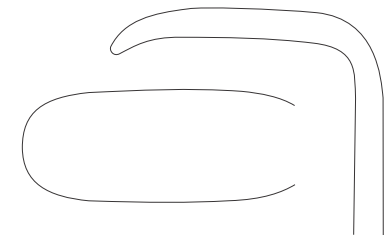

TS.09.71.12  
 14 x 33 mm

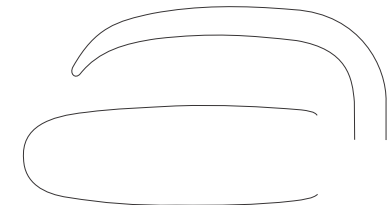

TS.09.71.13  
 13 x 42 mm

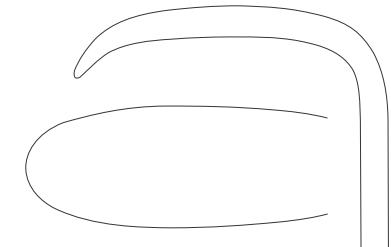

TS.09.71.16  
 16 x 42 mm

# Orthopedic Instruments



LANGENBECK  
21 cm/ 8¼"

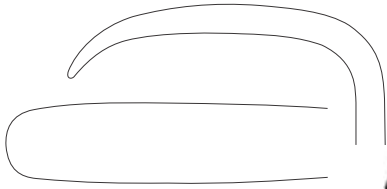

TS.09.72.10  
10 x 40 mm

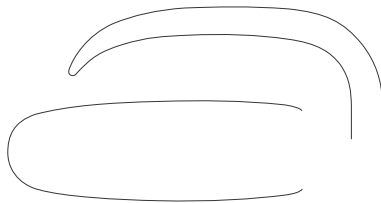

TS.09.72.13  
13 x 42 mm

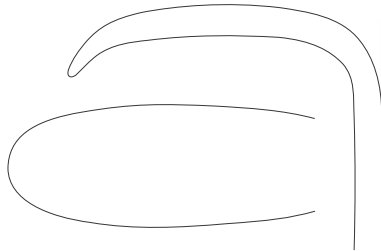

TS.09.72.16  
16 x 42 mm



LANGENBECK  
21 cm/ 8¼"

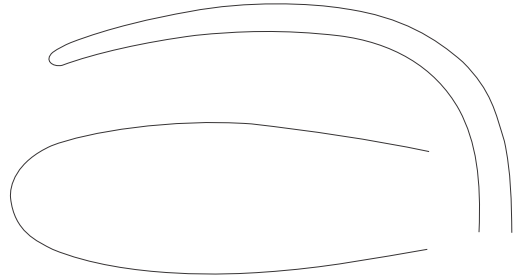

TS.09.72.20  
20 x 55 mm

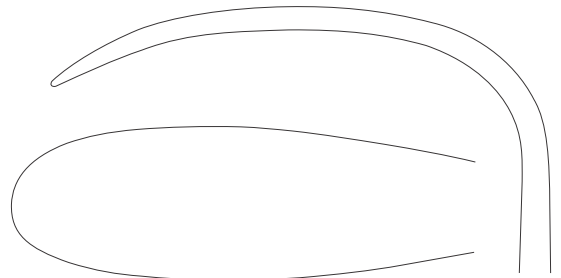

TS.09.72.21  
20 x 63 mm

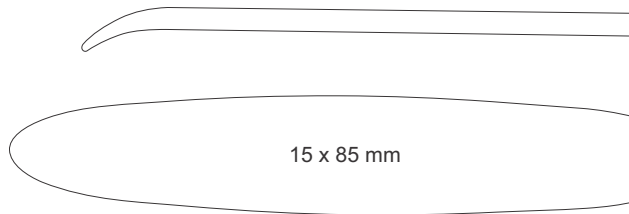

15 x 85 mm



LANGENBECK  
TS.09.72.25  
21 cm/ 8¼"



**KOCHER**  
 TS.09.65.22  
 22 cm / 8<sup>3</sup>/<sub>4</sub>"



**KOCHER**  
 TS.09.66.22  
 22 cm / 8<sup>3</sup>/<sub>4</sub>"

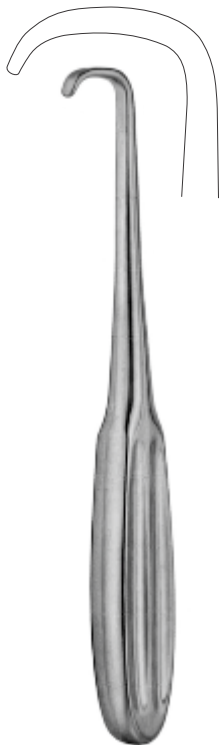

**LAHEY**  
 TS.09.69.95  
 19.5 cm / 7<sup>3</sup>/<sub>4</sub>"



**BILLROTH**  
 25 cm / 10"

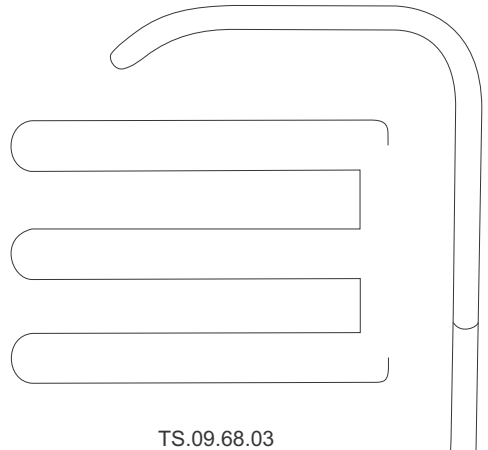

TS.09.68.03  
 35 X 43 mm

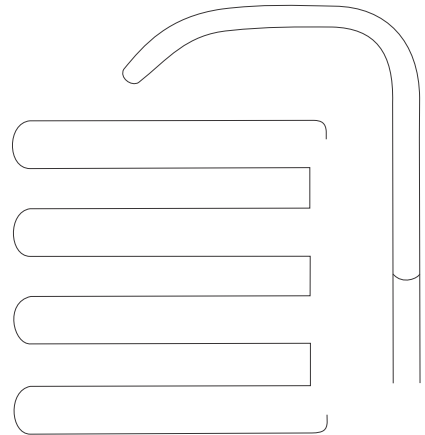

TS.09.68.04  
 40 X 35 mm

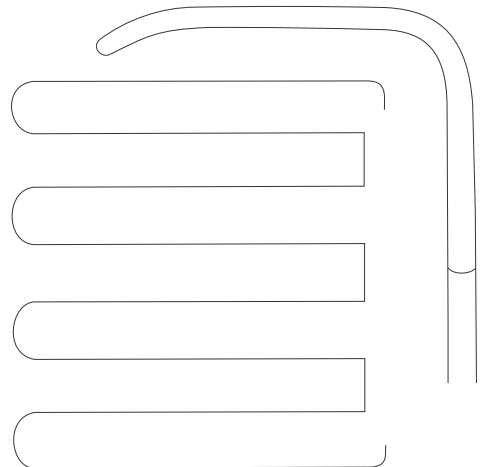

TS.09.68.14  
 50 X 45 mm

# Orthopedic Instruments



LANGENBECK  
21 cm / 8¼"



TS.09.70.10  
10 x 28 mm

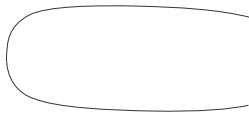

TS.09.70.14  
14 x 28 mm

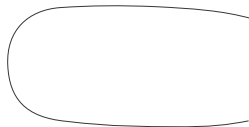

TS.09.70.16  
16 x 28 mm

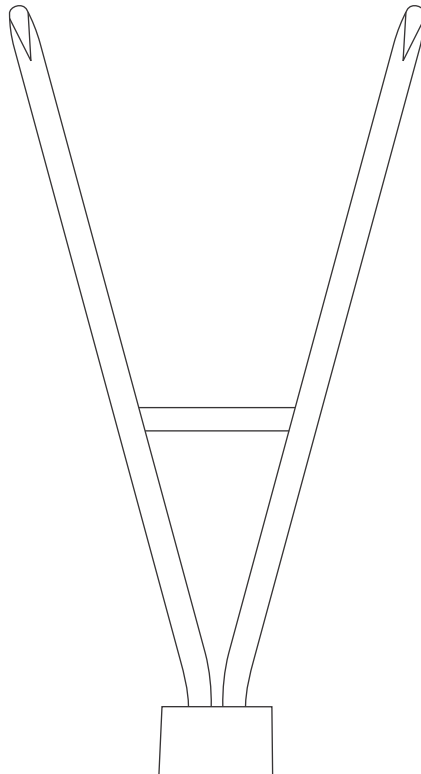

BERENS  
TS.09.67.21  
21 cm / 8¼"



**KOERTE**  
 24 cm / 9½"

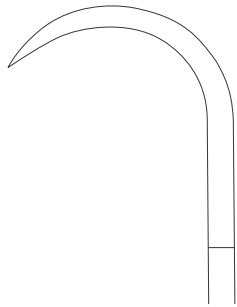

TS.09.75.08  
 40 x 28 mm

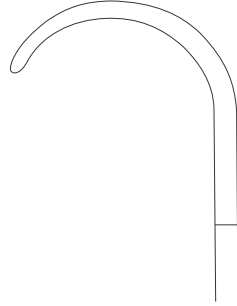

TS.09.76.18  
 40 x 28 mm



TS.09.76.26  
 24 cm / 9½"

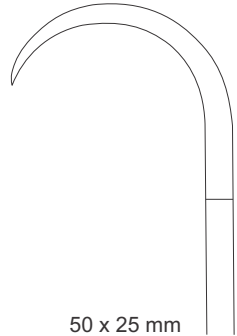

50 x 25 mm



TS.09.76.28  
 25 cm / 10"

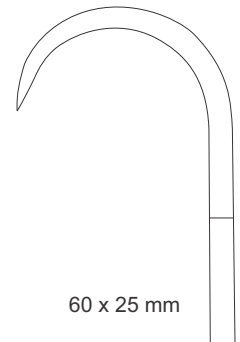

60 x 25 mm



# Orthopedic Instruments



KOCHER  
22 cm / 8 3/4"

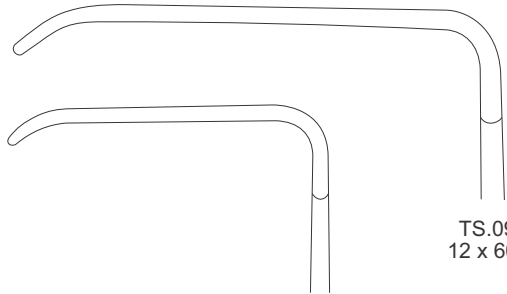

TS.09.76.31  
12 x 40 mm

TS.09.76.32  
12 x 60 mm



KOCHER  
23 cm / 9"

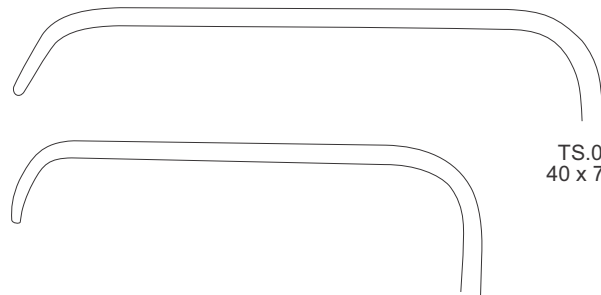

TS.09.76.70  
40 x 75 mm

TS.09.76.60  
20 x 60 mm

TS.09.76.55  
25 x 60 mm

TS.09.76.50  
30 x 60 mm

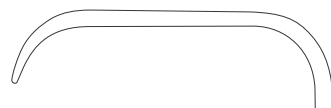

TS.09.76.48  
18 x 40 mm



SAUERBRUCH  
23 cm / 9"

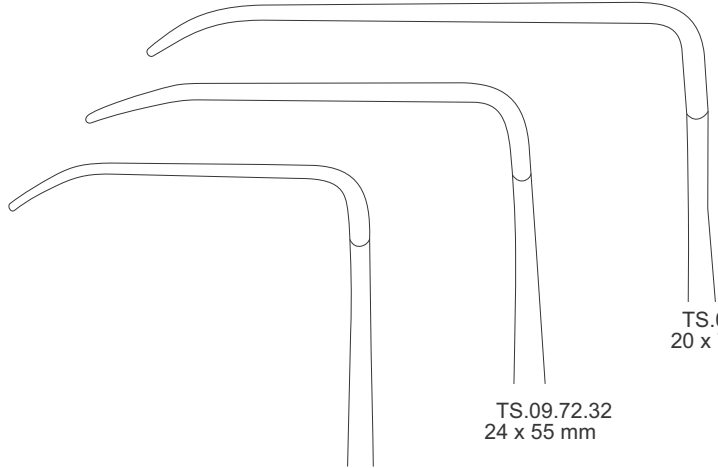

TS.09.72.31  
18 x 45 mm

TS.09.72.32  
24 x 55 mm

TS.09.72.33  
20 x 72 mm



KOCHER  
21 cm / 8 1/4"

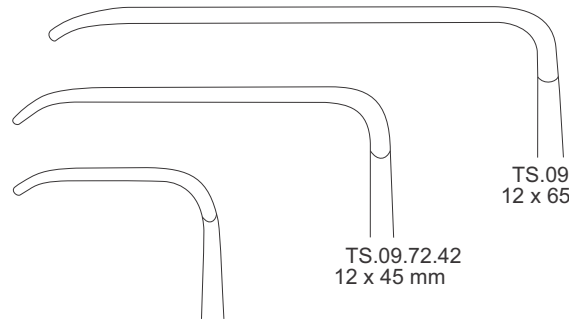

TS.09.72.41  
8 x 25 mm

TS.09.72.42  
12 x 45 mm

TS.09.72.43  
12 x 65 mm

# Orthopedic Instruments



KOCHER  
23 cm / 9"

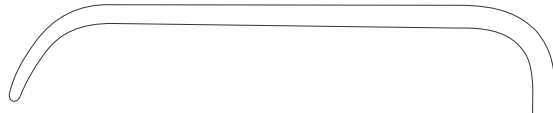

TS.09.72.57  
30 x 70 mm



TS.09.72.54  
30 x 40 mm

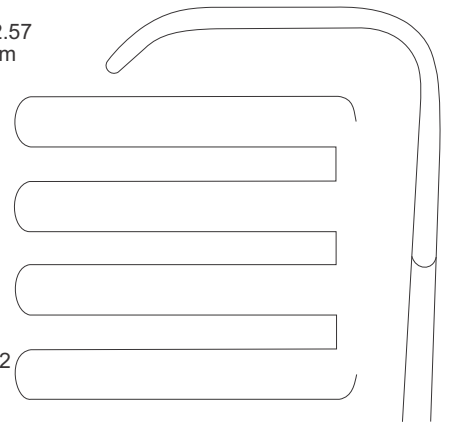

TS.09.74.22  
40 x 40 mm

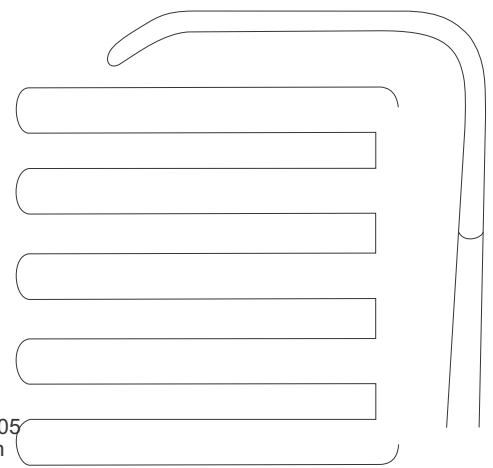
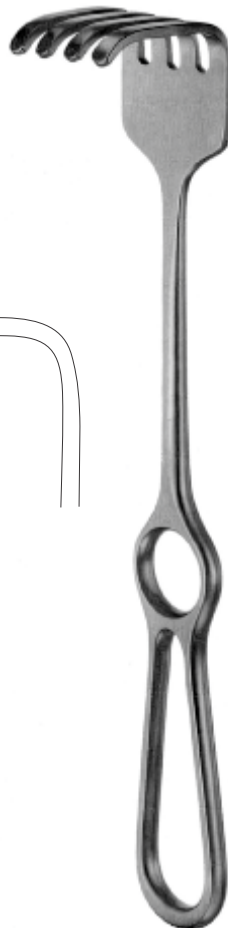

TS.09.74.05  
50 x 45 mm

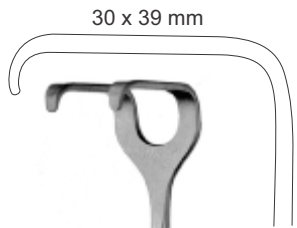

30 x 39 mm

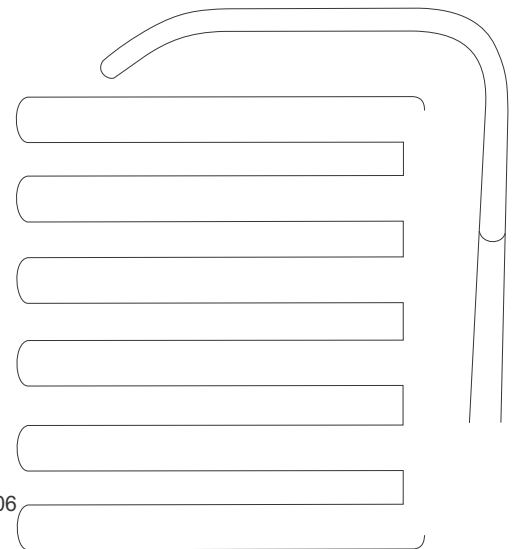

TS.09.74.06  
60 x 50 mm

OLLIER  
TS.09.73.22  
22 cm / 8¾"

ITSAEL  
25 cm / 10"



LANGENBECKOCHER  
 21 cm / 8 1/4"

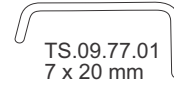

TS.09.77.01  
 7 x 20 mm

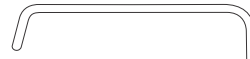

TS.09.77.02 7 x 30 mm  
 TS.09.77.03 10 x 30 mm  
 TS.09.77.04 15 x 30 mm  
 TS.09.77.05 20 x 30 mm

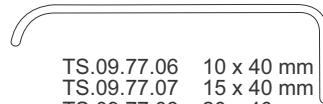

TS.09.77.06 10 x 40 mm  
 TS.09.77.07 15 x 40 mm  
 TS.09.77.08 20 x 40 mm

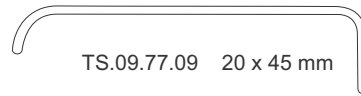

TS.09.77.09 20 x 45 mm

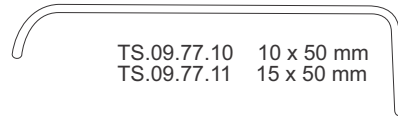

TS.09.77.10 10 x 50 mm  
 TS.09.77.11 15 x 50 mm

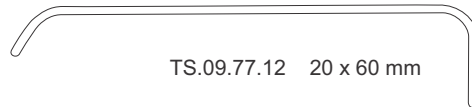

TS.09.77.12 20 x 60 mm

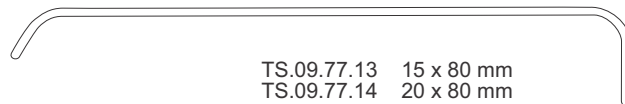

TS.09.77.13 15 x 80 mm  
 TS.09.77.14 20 x 80 mm

# Orthopedic Instruments

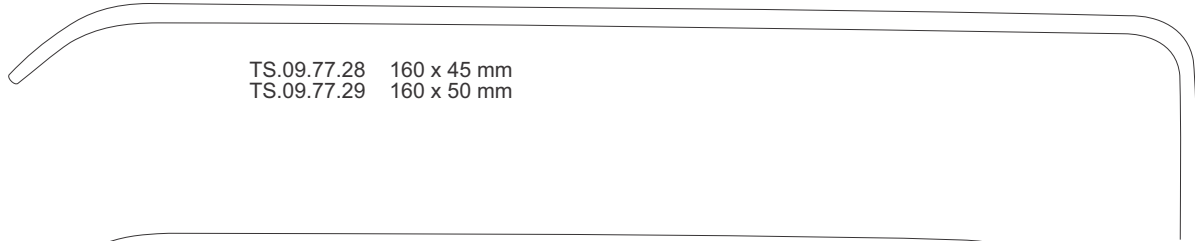

TS.09.77.28 160 x 45 mm  
TS.09.77.29 160 x 50 mm

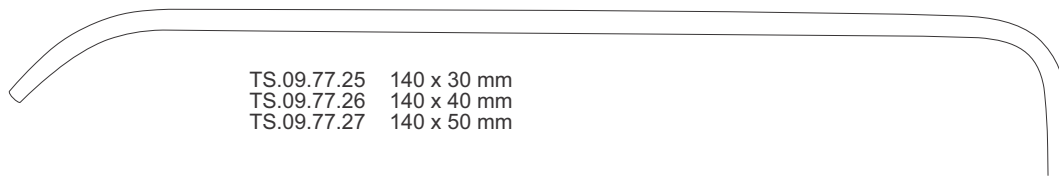

TS.09.77.25 140 x 30 mm  
TS.09.77.26 140 x 40 mm  
TS.09.77.27 140 x 50 mm

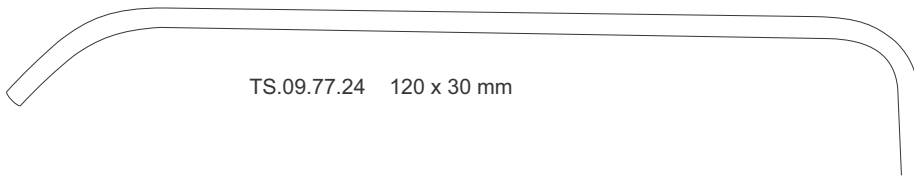

TS.09.77.24 120 x 30 mm

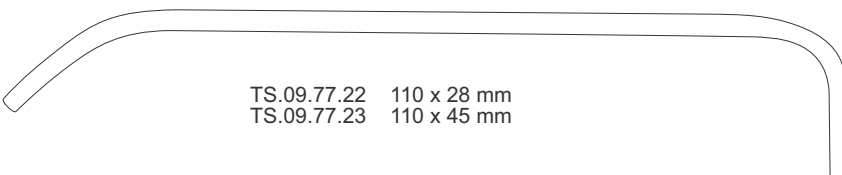

TS.09.77.22 110 x 28 mm  
TS.09.77.23 110 x 45 mm

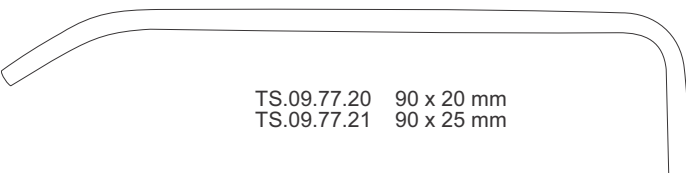

TS.09.77.20 90 x 20 mm  
TS.09.77.21 90 x 25 mm



for anterior spondylosis operations

24 cm/ 9½"

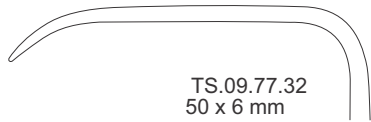
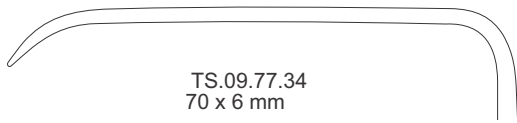
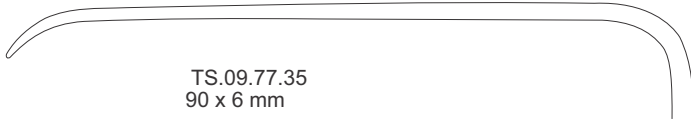

Joint retractor,  
oval rounded blades

conical tip



22 cm/ 8 $\frac{3}{4}$ "



MORRIS  
TS.09.78.21  
22.5 cm/ 9"

# Orthopedic Instruments

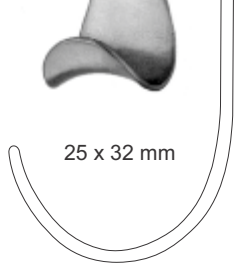
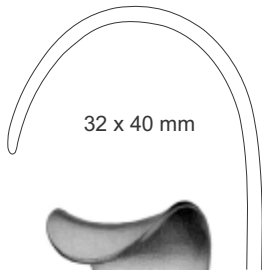

GOELET  
TS.09.80.19  
19 cm / 7½"



KOCHER  
20 cm / 8"

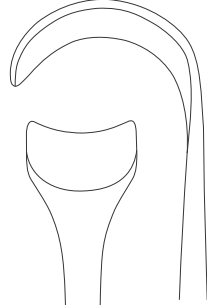
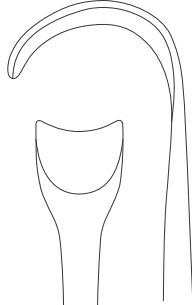

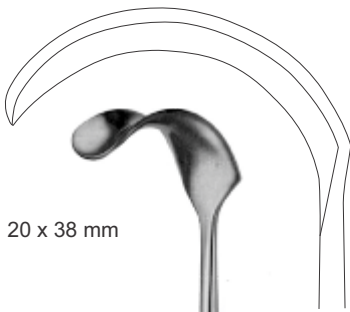

20 x 38 mm

KOCHER  
TS.09.83.23  
23 cm/ 9"



KOCHER  
25.5 cm/ 10"

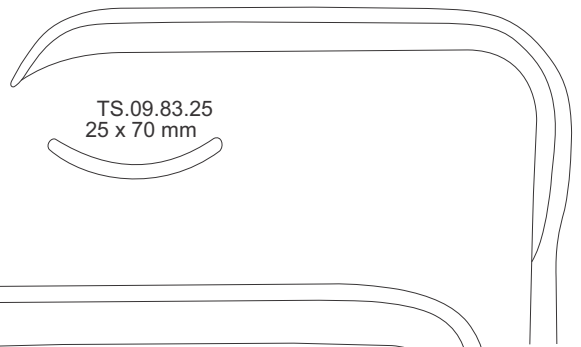

TS.09.83.25  
25 x 70 mm

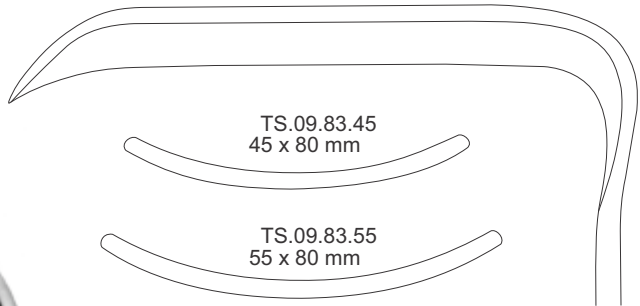

TS.09.83.45  
45 x 80 mm

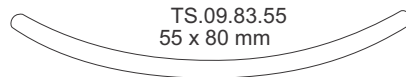

TS.09.83.55  
55 x 80 mm

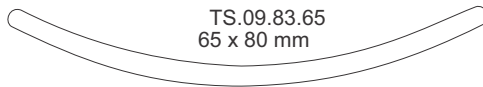

TS.09.83.65  
65 x 80 mm



# Orthopedic Instruments

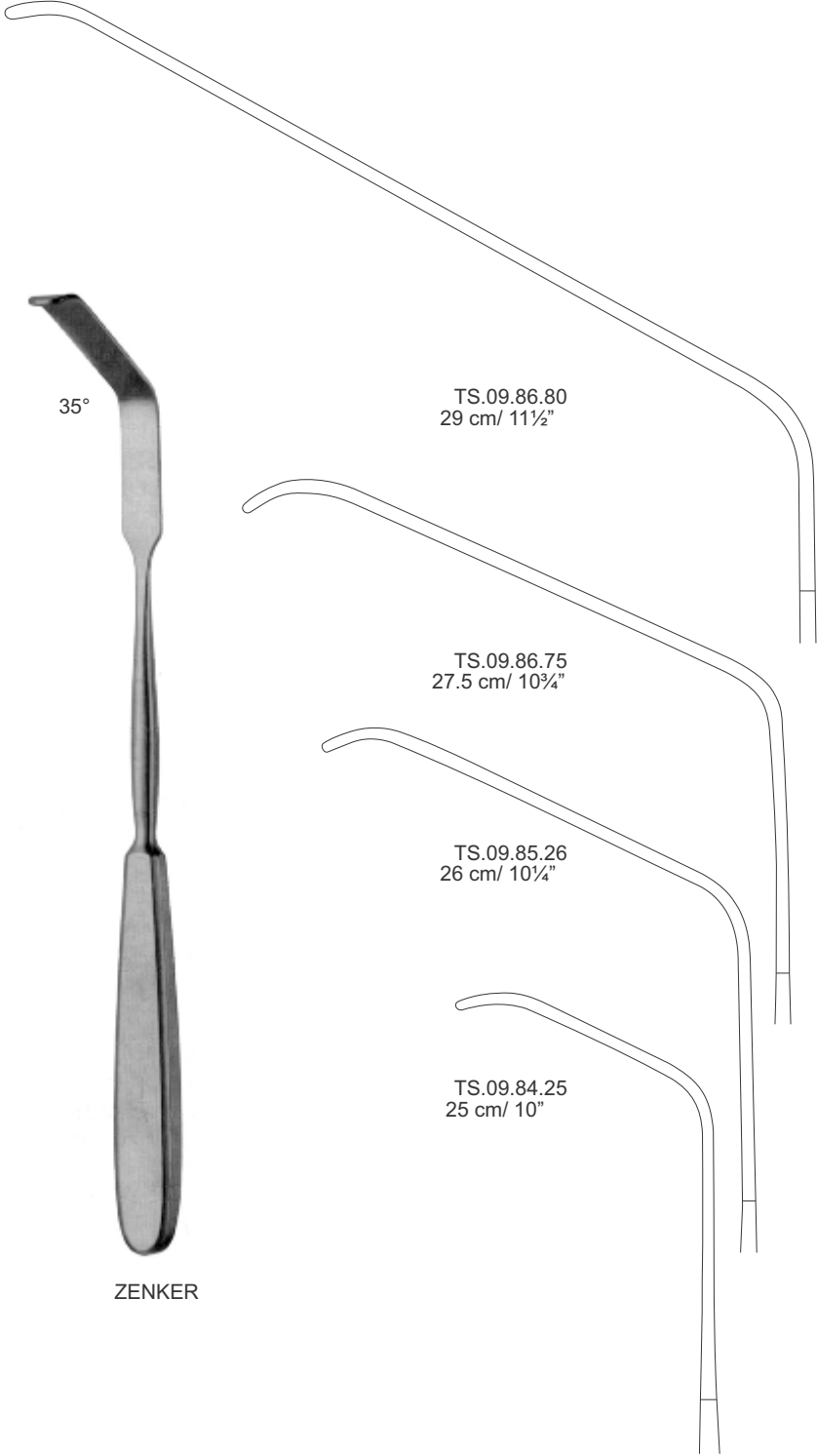



17 x 14 mm

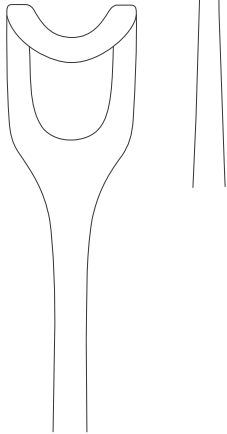

TS.09.87.01  
 19.5 cm / 7¾"

22 x 20 mm

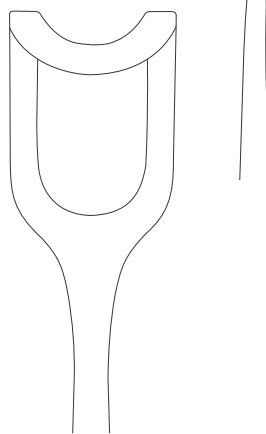

TS.09.87.02  
 20.5 cm / 8½"

30 x 26 mm

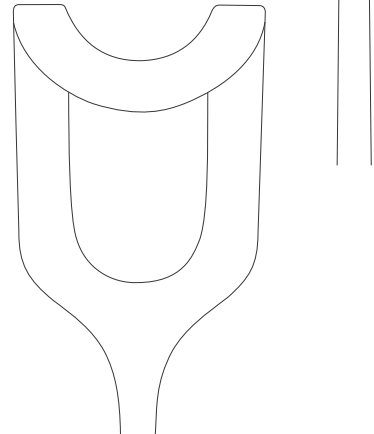

TS.09.87.03  
 23 cm / 9"

MIDDELDORPF



17 x 14 mm

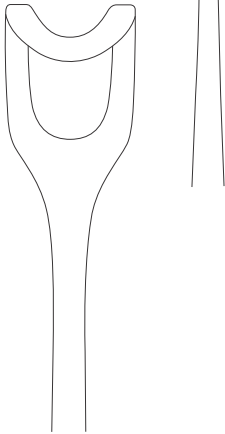

TS.09.88.11  
 20.5 cm / 8½"

22 x 20 mm

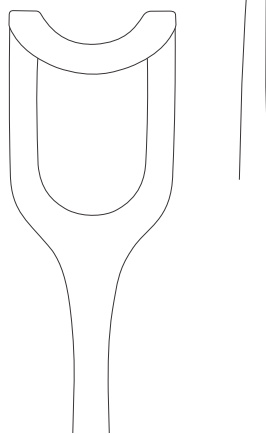

TS.09.88.12  
 22.5 cm / 9"

30 x 26 mm

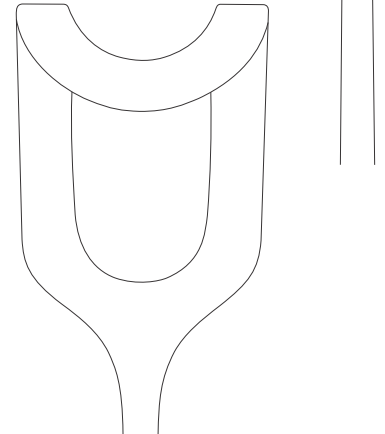

TS.09.88.13  
 23.5 cm / 9¼"

MIDDELDORPF

# Orthopedic Instruments

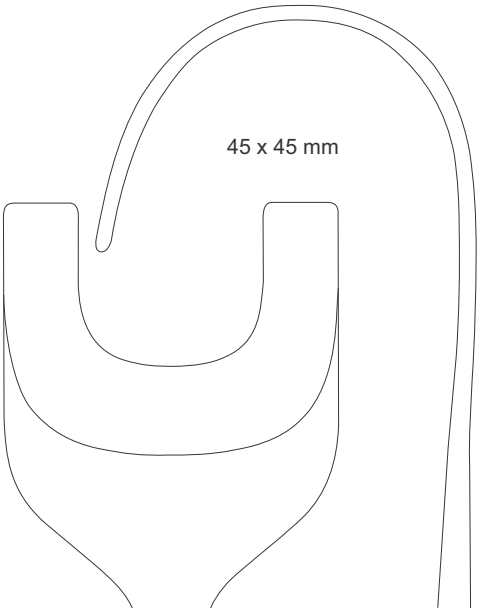

TS.09.89.21

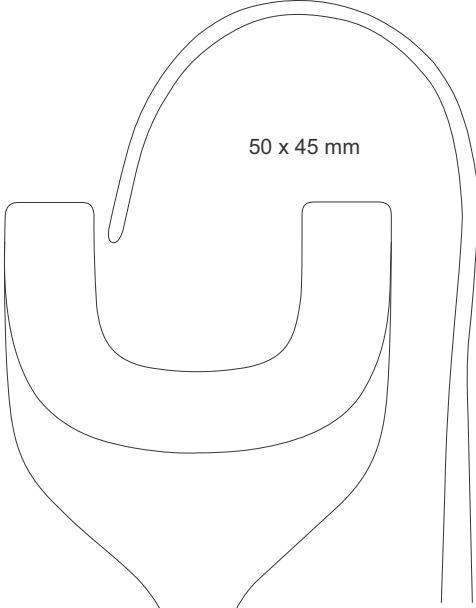

TS.09.89.22



**MIDDELDORPF**  
25 cm / 10"

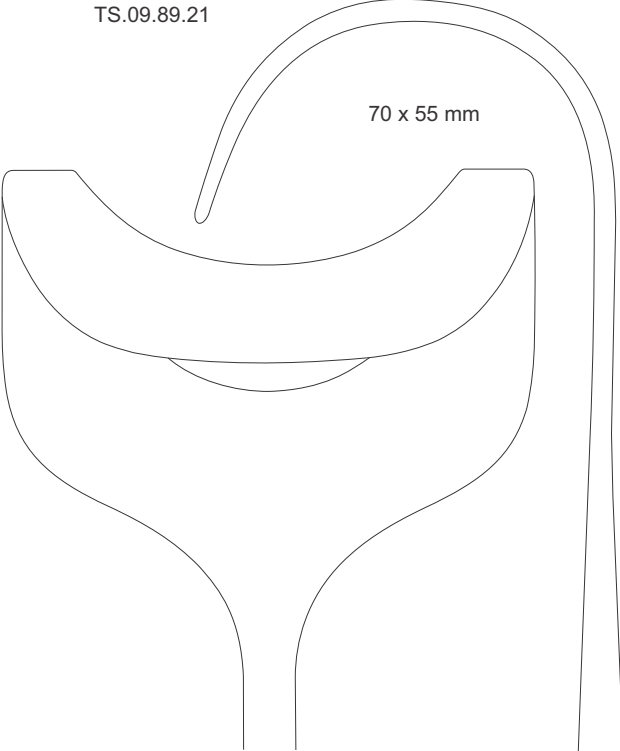

TS.09.89.23

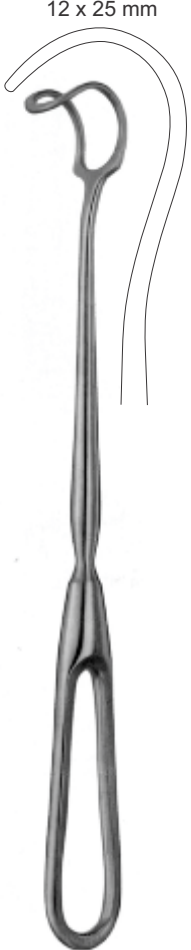

**GREEN**  
TS.09.90.12  
25.3 cm / 9"

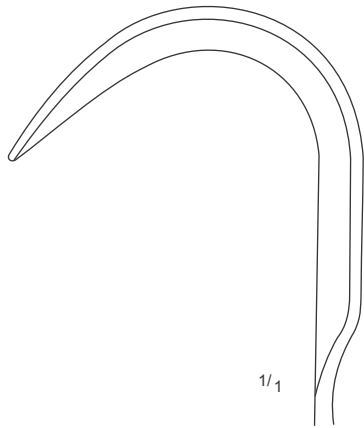

**FRITSCH**  
23 cm / 9"



**TS.09.91.23**  
30 x 30 mm



**TS.09.91.26**  
40 x 30 mm

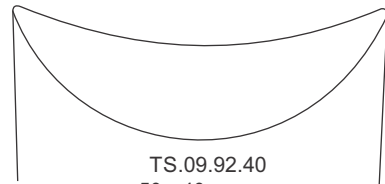

**TS.09.92.40**  
50 x 40 mm

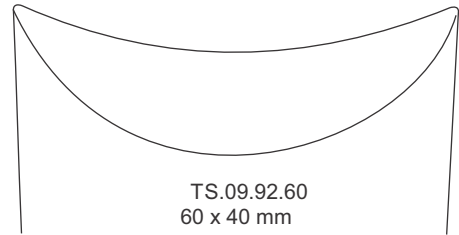

**TS.09.92.60**  
60 x 40 mm

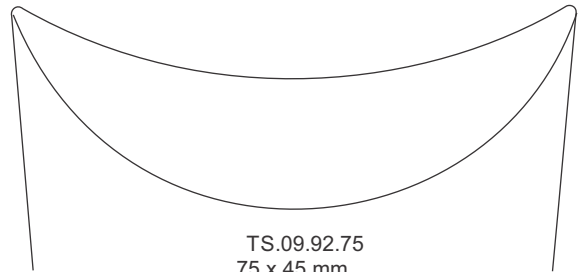

**TS.09.92.75**  
75 x 45 mm

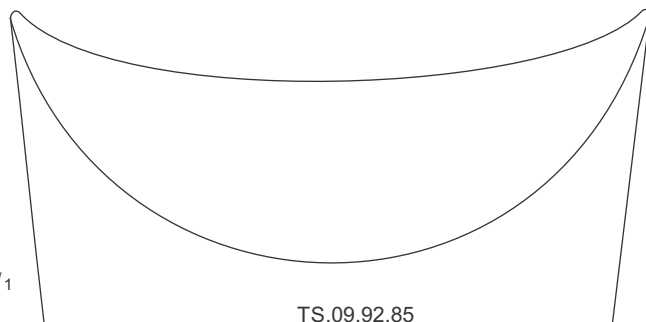

**TS.09.92.85**  
85 x 65 mm

# Orthopedic Instruments

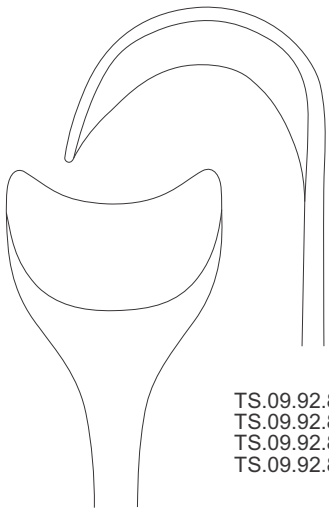

TS.09.92.81 10 x 30 mm  
TS.09.92.82 15 x 30 mm  
TS.09.92.83 20 x 30 mm  
TS.09.92.84 30 x 30 mm



**FRITSCH (KOCHER)**  
25.5 cm/ 10"

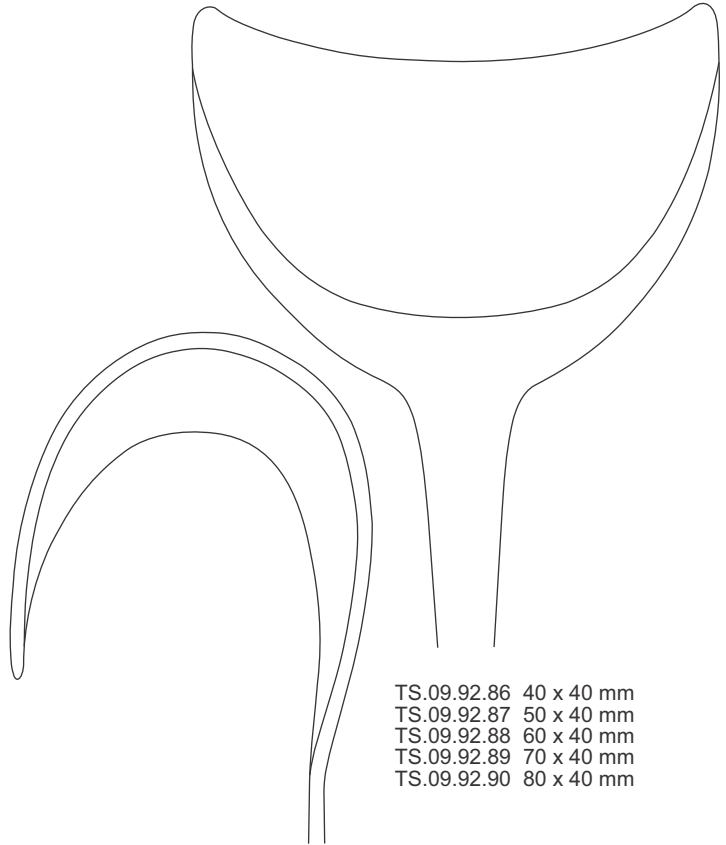

TS.09.92.86 40 x 40 mm  
TS.09.92.87 50 x 40 mm  
TS.09.92.88 60 x 40 mm  
TS.09.92.89 70 x 40 mm  
TS.09.92.90 80 x 40 mm

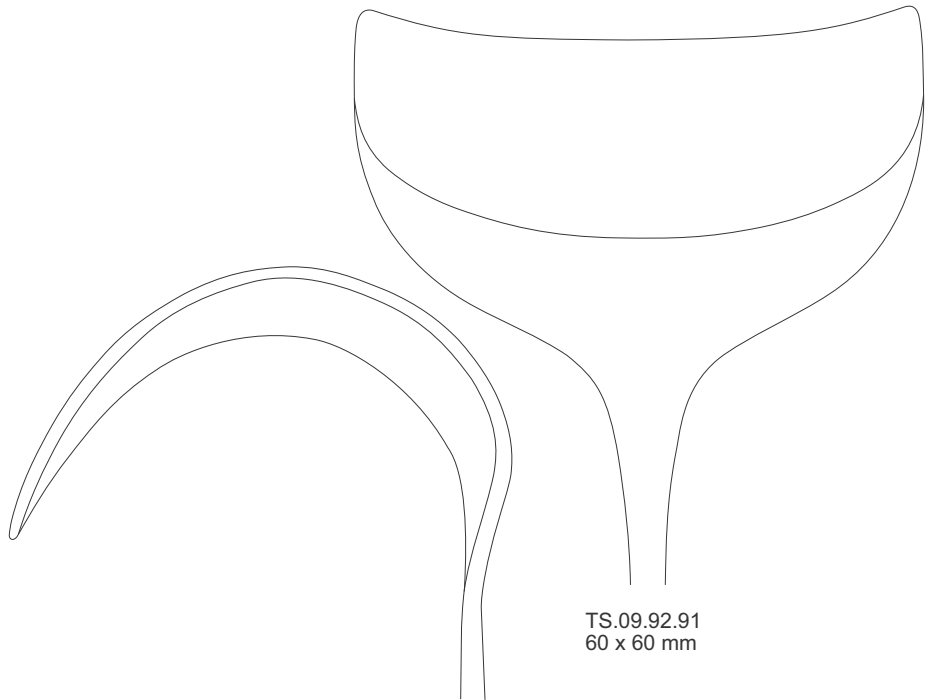

TS.09.92.91  
60 x 60 mm

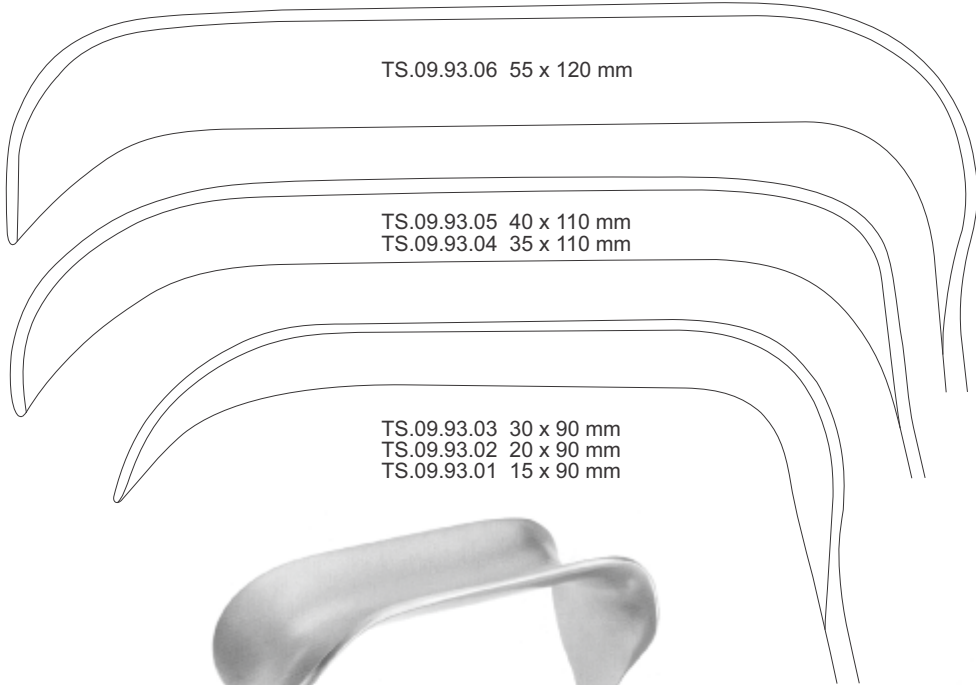

TS.09.93.06 55 x 120 mm

TS.09.93.05 40 x 110 mm  
TS.09.93.04 35 x 110 mm

TS.09.93.03 30 x 90 mm  
TS.09.93.02 20 x 90 mm  
TS.09.93.01 15 x 90 mm



DOYEN-STILLE  
24 cm/ 9½"

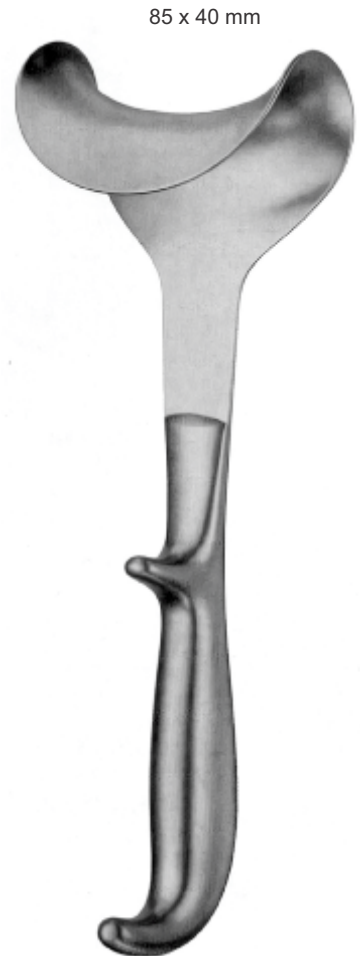

85 x 40 mm

DOYEN  
TS.09.94.80  
23 cm/ 9"

# Orthopedic Instruments

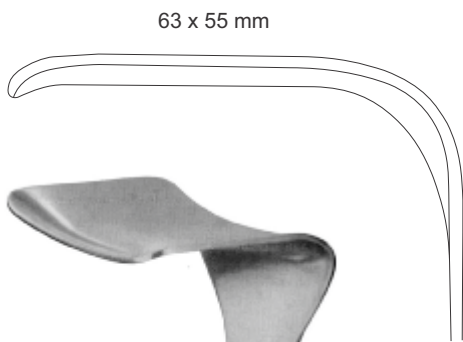
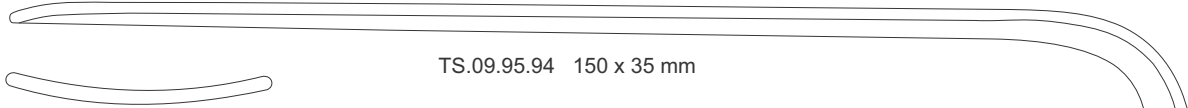

TUFFIER  
TS.09.95.90  
23 cm/ 9"

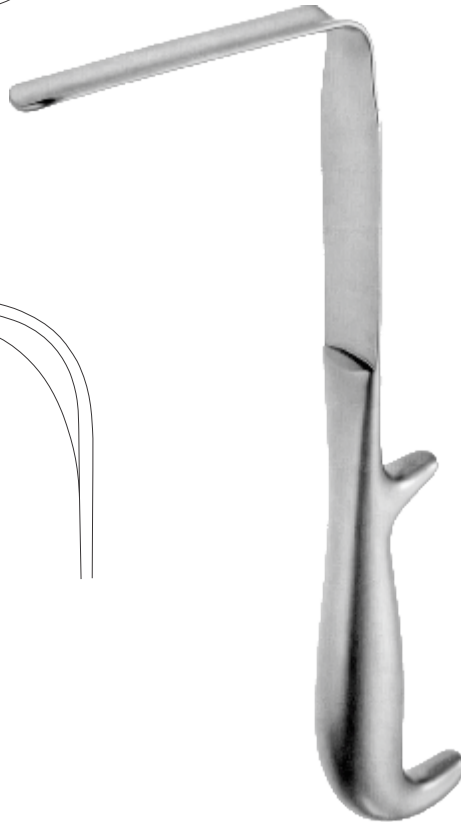

DOYEN  
23 cm/ 9"

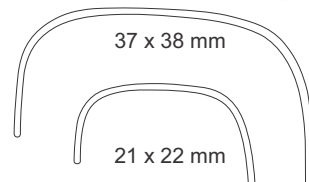

RICHARDSON-EASTMAN  
TS.09.96.50

Set complete

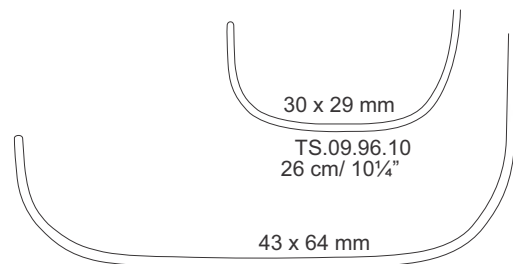



RICHARDSON  
24 cm / 9½"

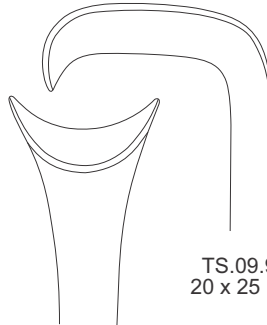

TS.09.97.01  
20 x 25 mm

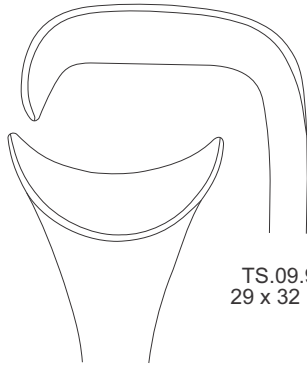

TS.09.97.02  
29 x 32 mm

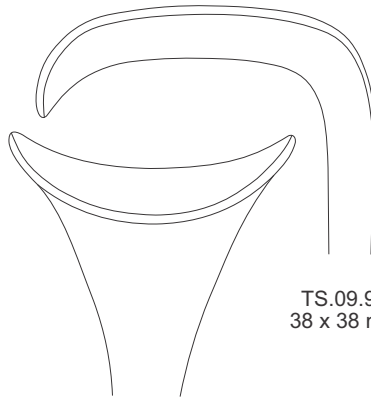

TS.09.97.03  
38 x 38 mm

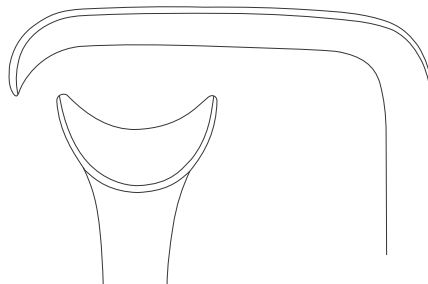

TS.09.97.04  
21 x 48 mm



# Orthopedic Instruments

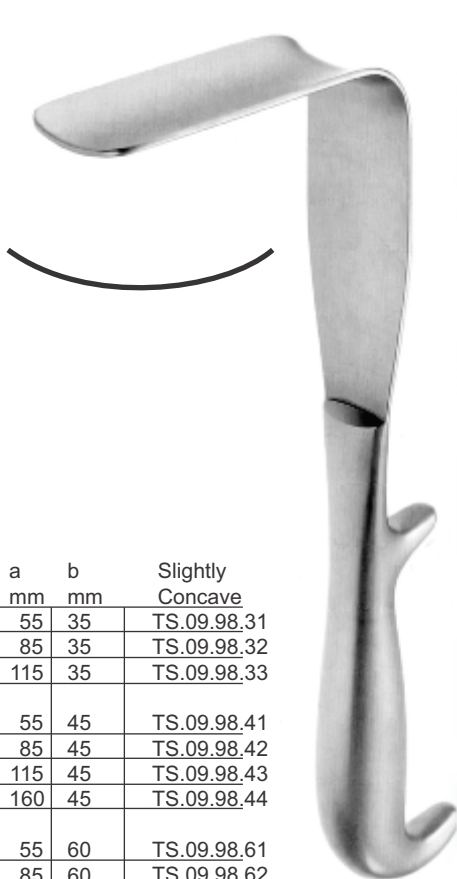
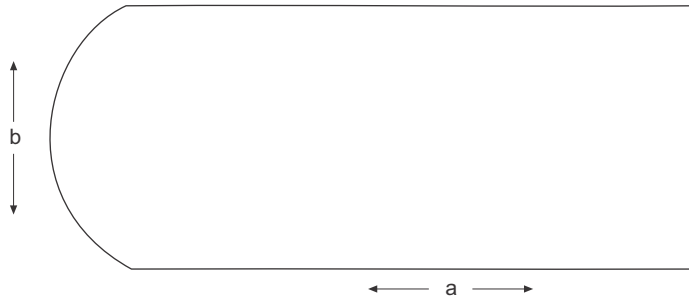

a mm	b mm	Slightly Concave
55	35	TS.09.98.31
85	35	TS.09.98.32
115	35	TS.09.98.33
55	45	TS.09.98.41
85	45	TS.09.98.42
115	45	TS.09.98.43
160	45	TS.09.98.44
55	60	TS.09.98.61
85	60	TS.09.98.62
115	60	TS.09.98.63
160	60	TS.09.98.64

DOYEN  
24 cm/ 9½"

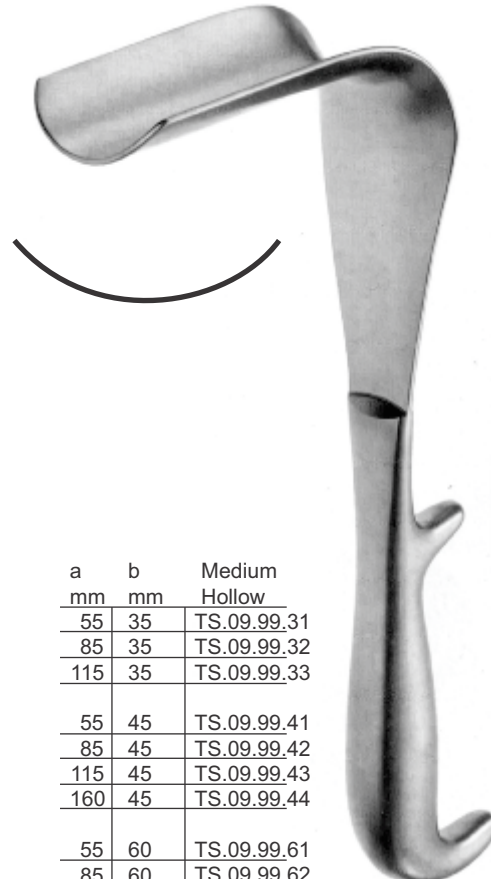

a mm	b mm	Medium Hollow
55	35	TS.09.99.31
85	35	TS.09.99.32
115	35	TS.09.99.33
55	45	TS.09.99.41
85	45	TS.09.99.42
115	45	TS.09.99.43
160	45	TS.09.99.44
55	60	TS.09.99.61
85	60	TS.09.99.62
115	60	TS.09.99.63
160	60	TS.09.99.64

DOYEN  
24 cm/ 9½"



KELLY  
26 cm/ 10¼"

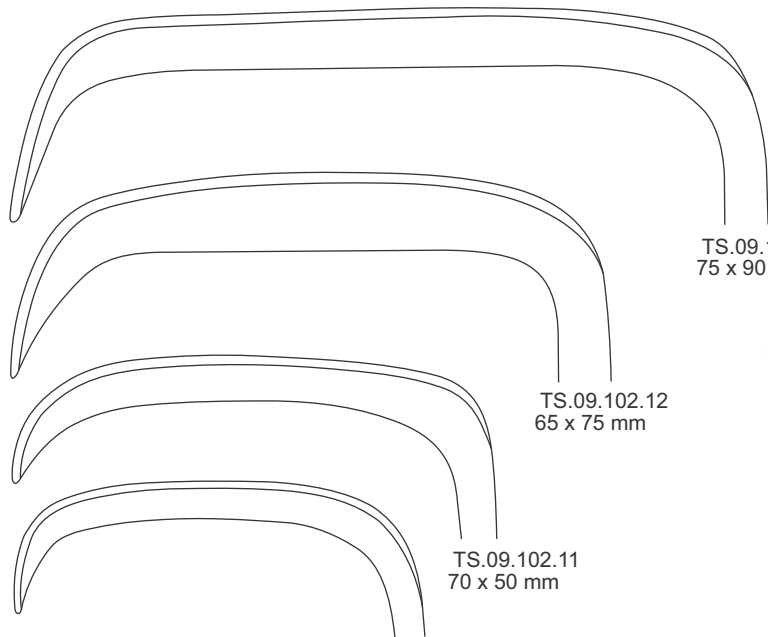

TS.09.102.13  
75 x 90 mm

TS.09.102.12  
65 x 75 mm

TS.09.102.11  
70 x 50 mm

TS.09.102.10  
40 x 50 mm



SAUERBRUCH  
TS.09.101.50  
25 cm/ 10"



REHN  
25 cm/ 10"

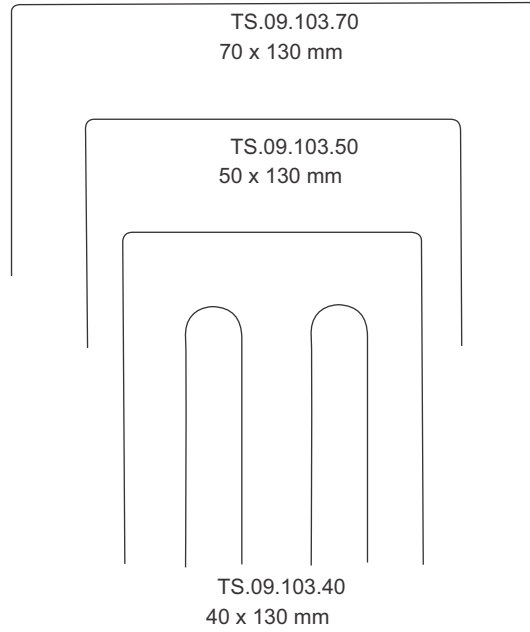

MEYERDING

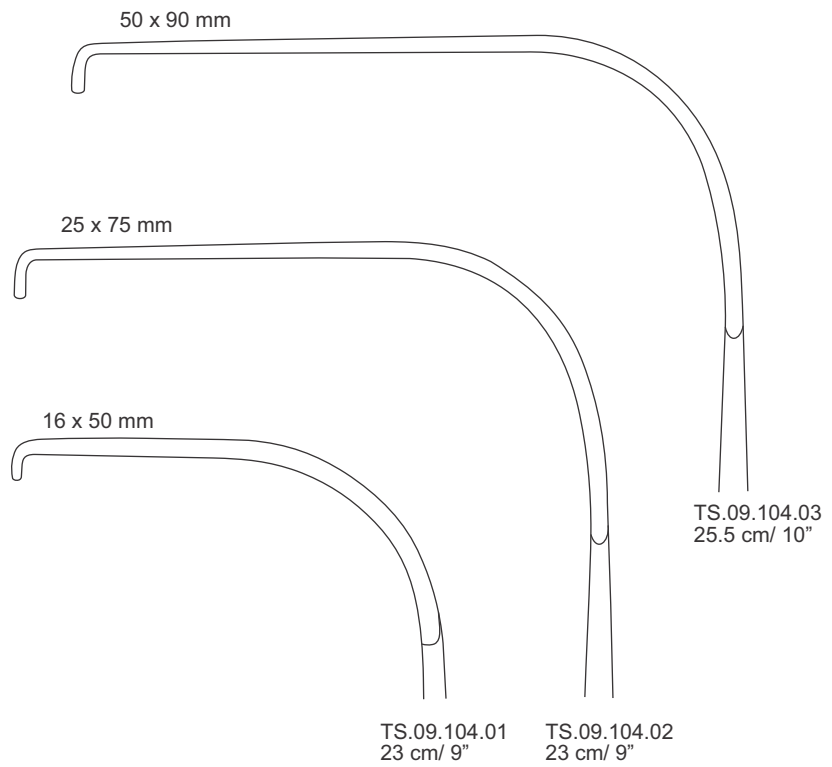

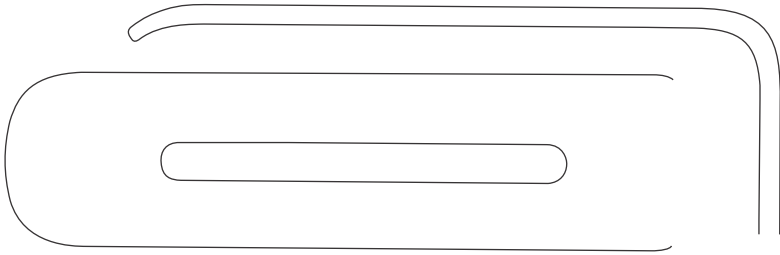

TS.09.105.01  
23 x 85 mm

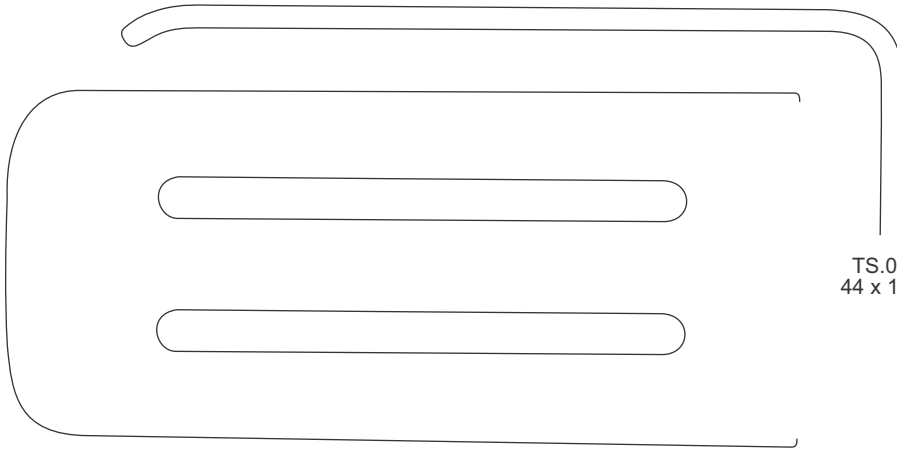

TS.09.106.02  
44 x 105 mm

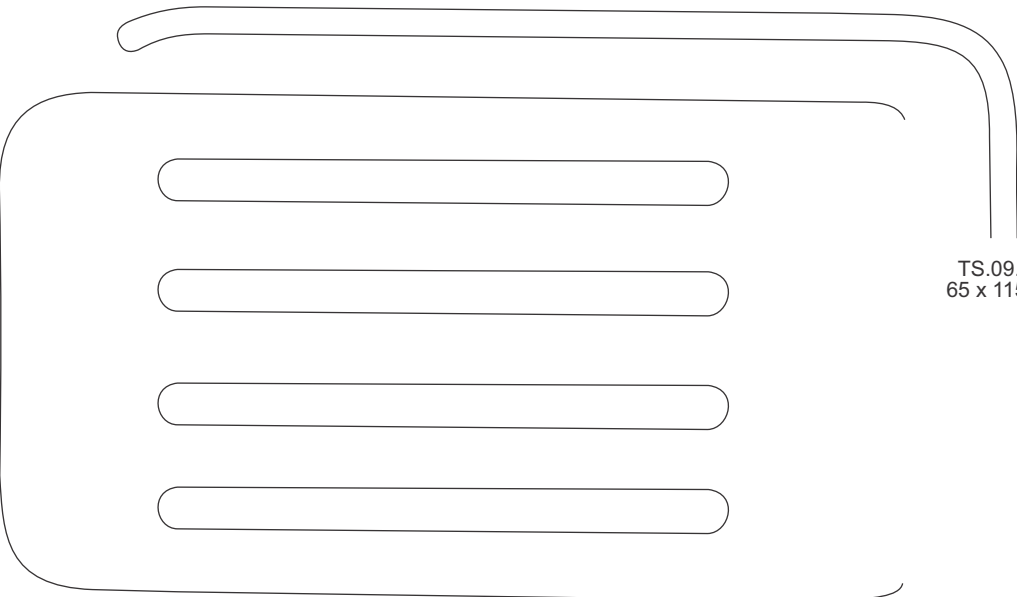

TS.09.107.03  
65 x 115 mm



CORYLLOS  
23 cm/ 9"

# Orthopedic Instruments

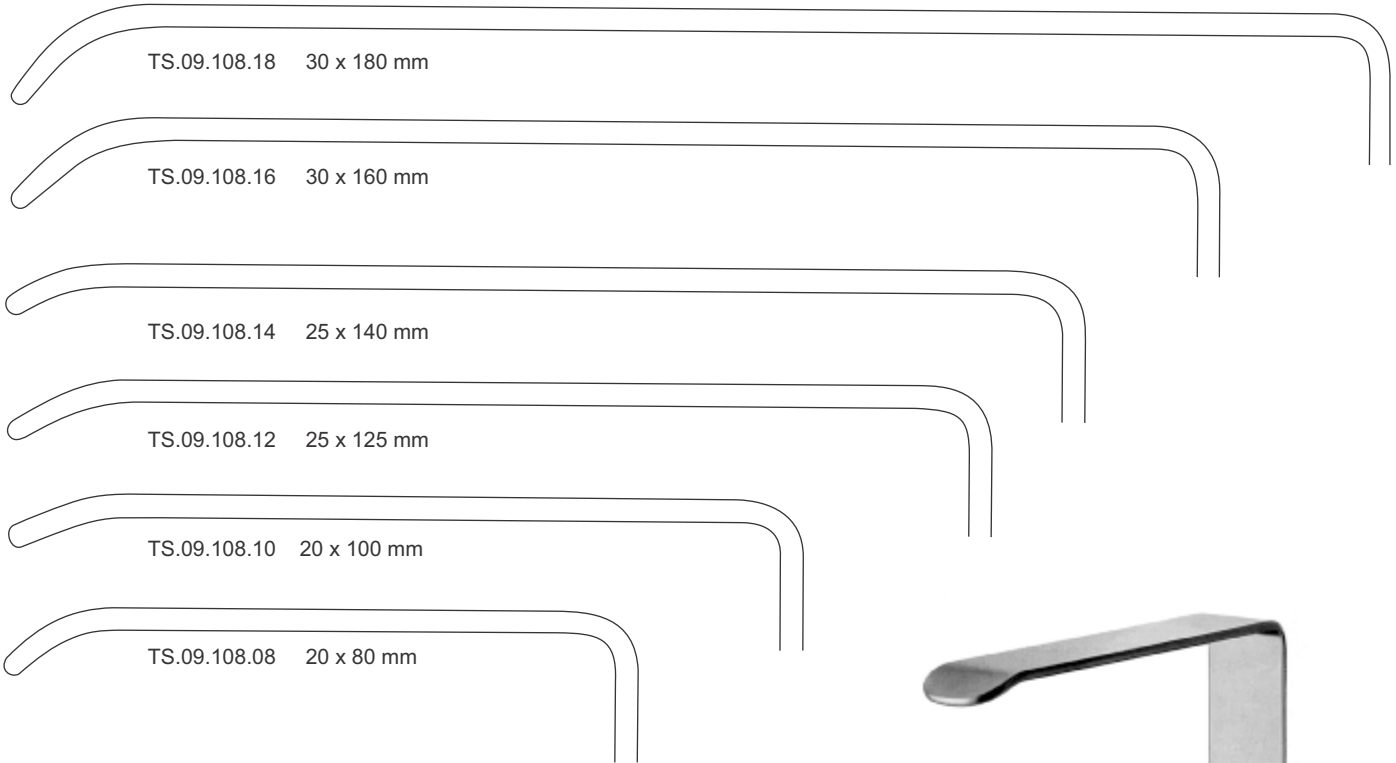

BRUNNER  
25 cm/ 10"

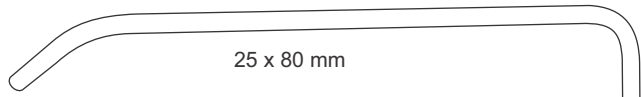

25 x 80 mm

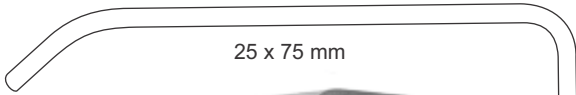

25 x 75 mm

TS.09.109.25  
24 cm/ 9½"



TS.09.109.75  
23 cm/ 9"

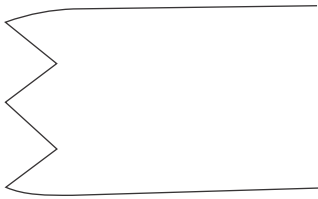

HIBBS  
TS.09.109.80

Set complete



55 x 85 mm

MIKULICZ  
TS.09.110.25  
25.5 cm/ 10"

# Orthopedic Instruments

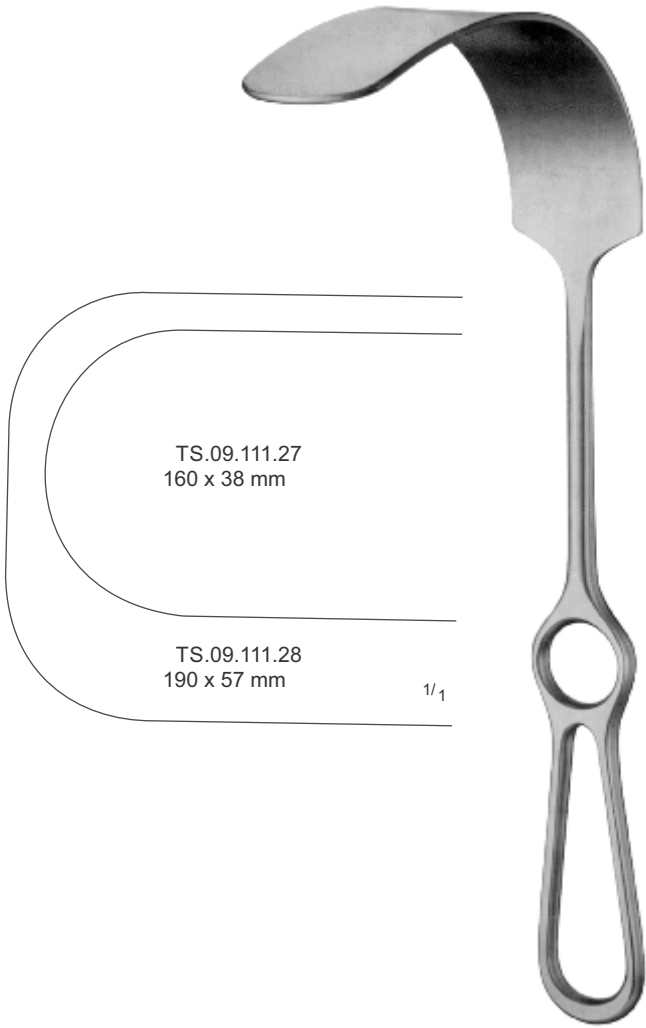
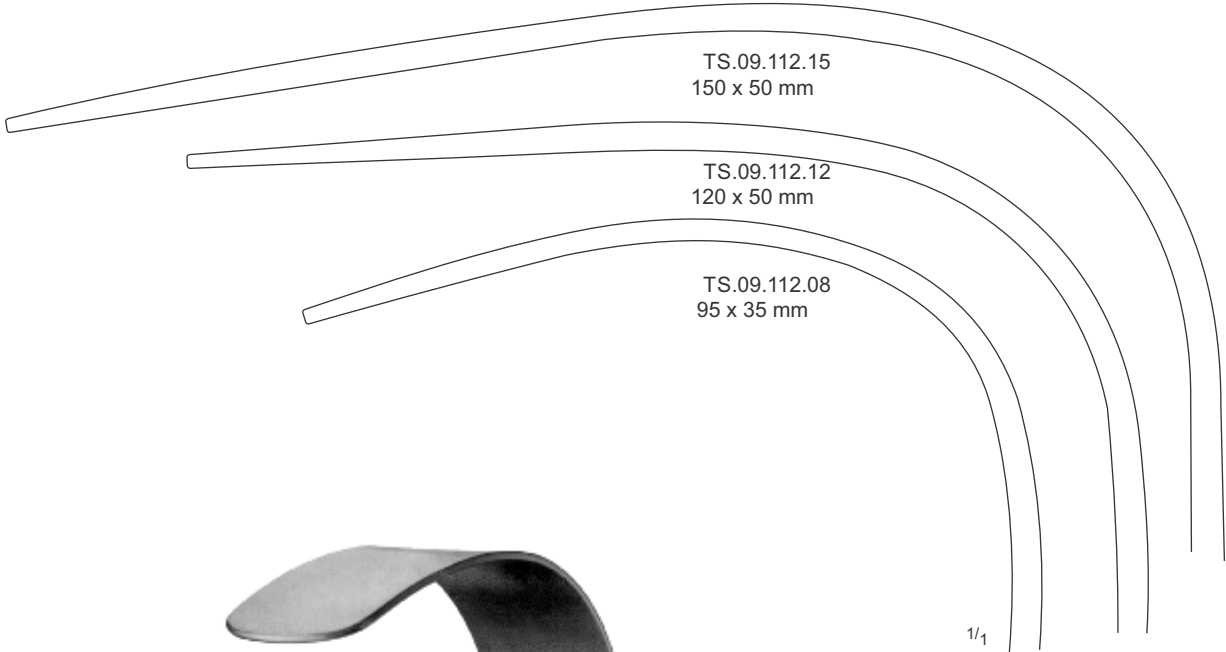

KELLY  
TS.09.111.27  
27 cm/ 10<sup>3</sup>/<sub>4</sub>"

MIKULICZ  
26 cm/ 10<sup>3</sup>/<sub>4</sub>"

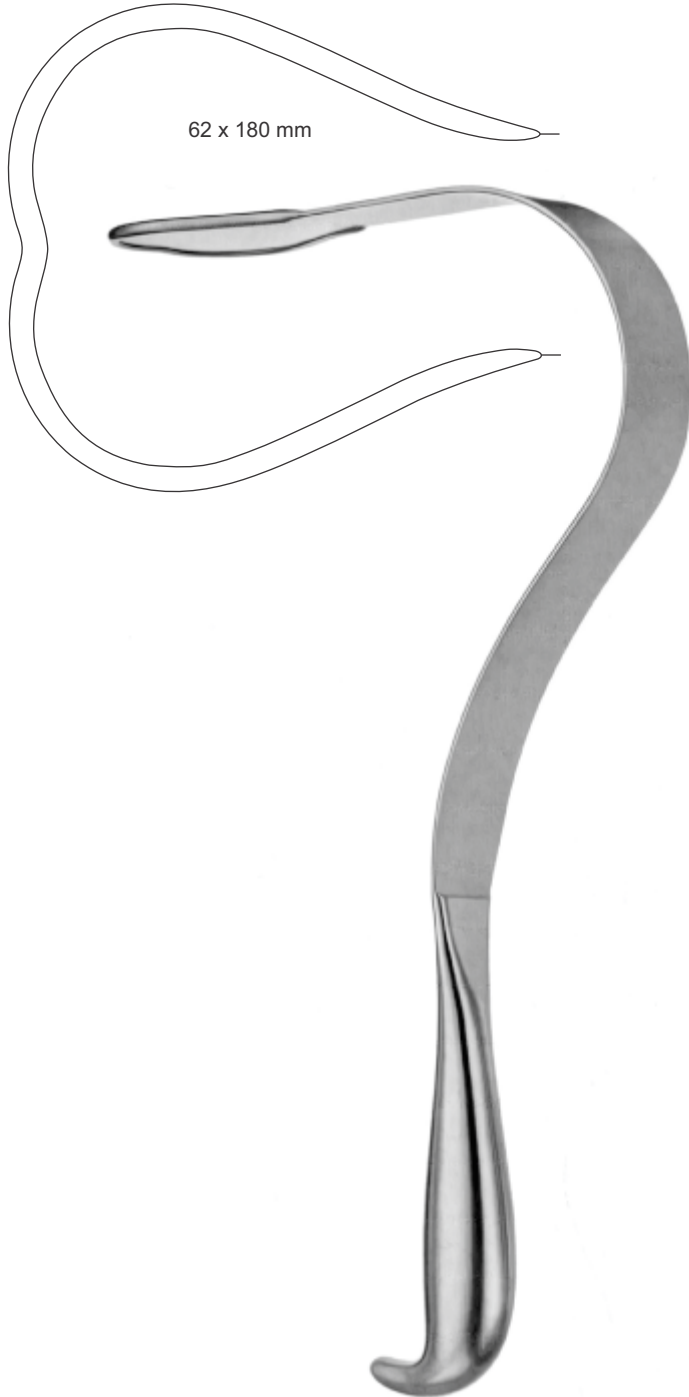

HARRINGTON-PEMBERTON  
TS.09.113.32  
32 cm / 12½"



HARRINGTON-BABY  
TS.09.115.24  
27 cm / 10¾"



# Orthopedic Instruments

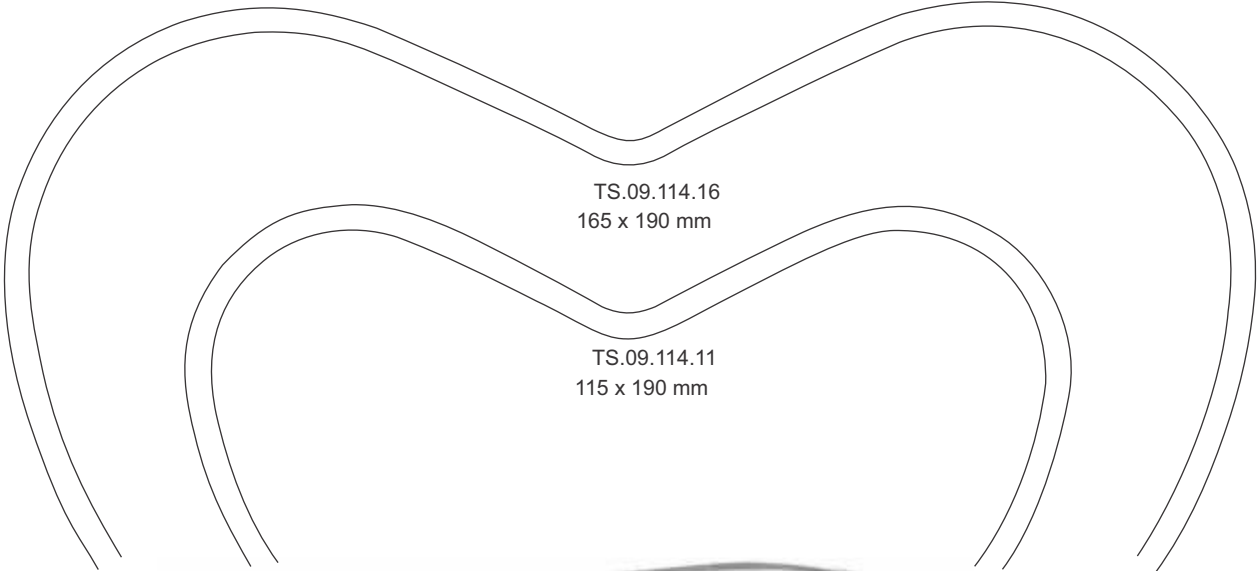

TS.09.114.16  
165 x 190 mm

TS.09.114.11  
115 x 190 mm



HARRINGTON  
32 cm / 12½"

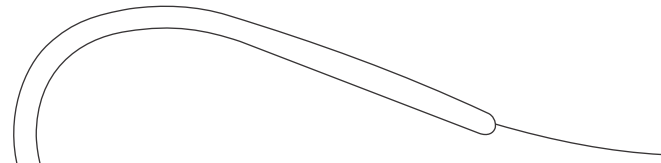

TS.09.116.33  
62 x 127 mm

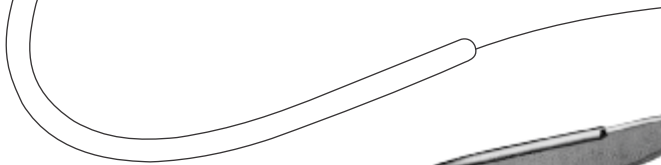

TS.09.116.32  
40 x 127 mm

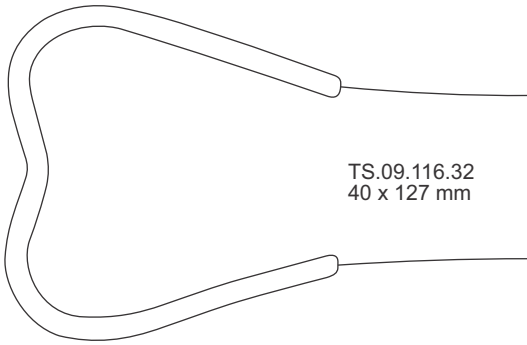

HARRINGTON  
32 cm / 12½"

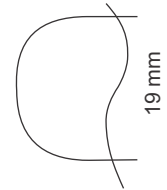

19 mm



DEAVER  
TS.09.117.01  
# 000  
18 cm / 7⅛"

# Orthopedic Instruments





DEAVER  
TS.09.118.03  
# 3  
30 cm/ 11¼"

DEAVER  
TS.09.118.04  
# 4  
30 cm/ 11¼"

DEAVER  
TS.09.118.05  
# 5  
30 cm/ 11¼"

# Orthopedic Instruments

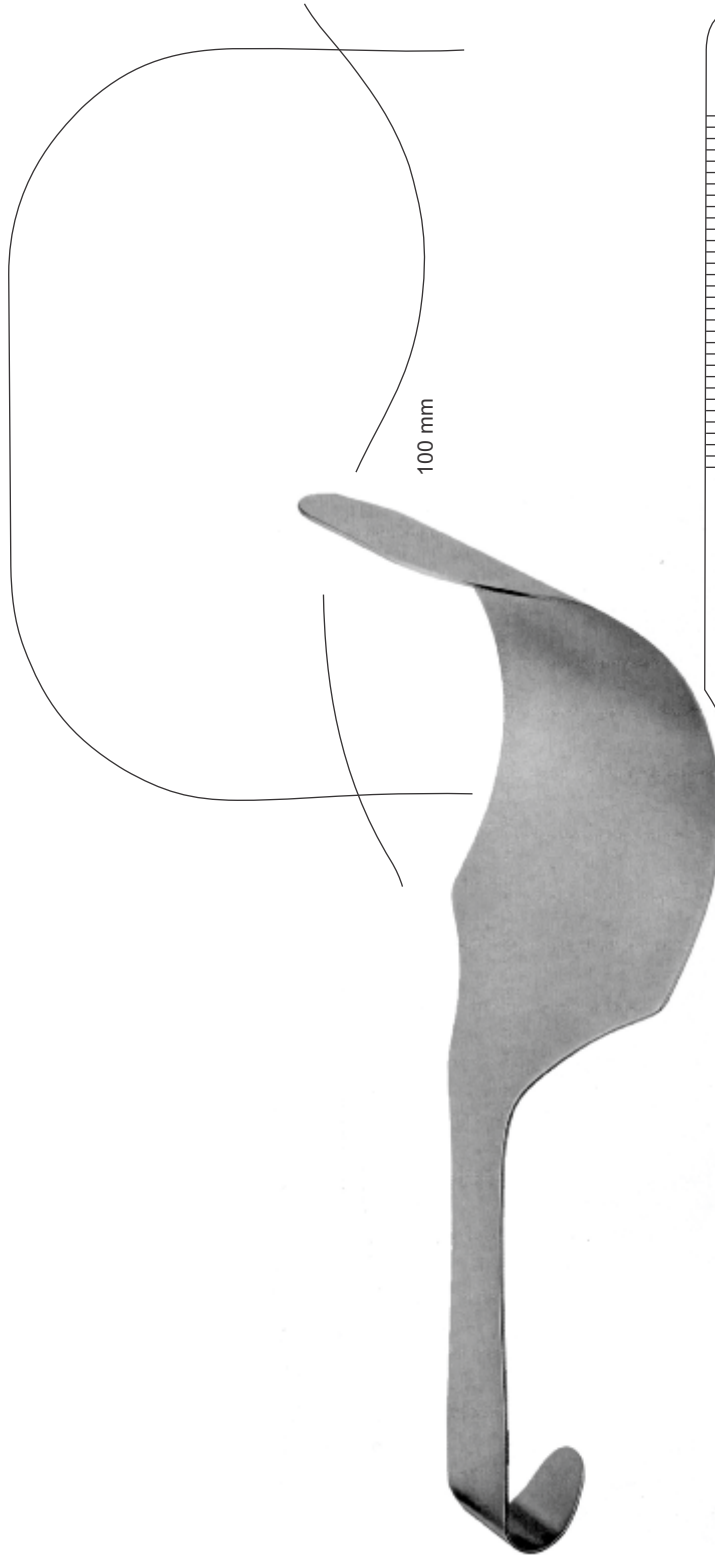

DEAVER  
TS.09.118.06  
# 6  
30 cm/ 11¼"

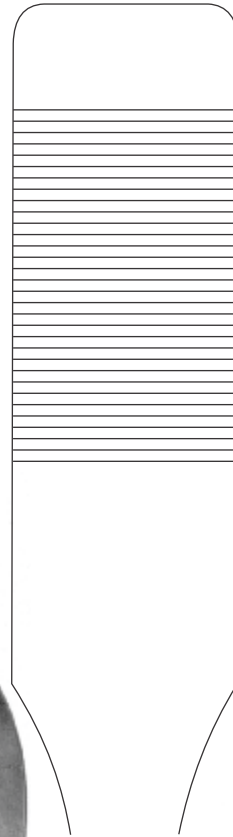

TS.09.119.03  
30 mm

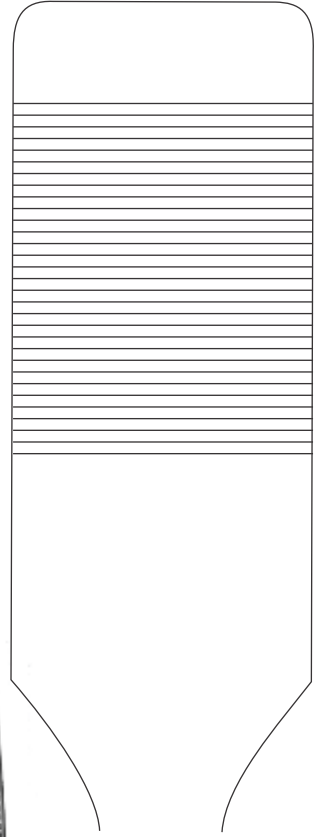

TS.09.119.04  
40 mm



KADER  
27 cm/ 10¾"

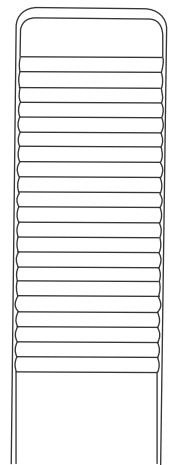

TS.09.119.02  
20 mm

30 x 100 mm



MIKULICZ  
TS.09.120.26  
25.5 cm/ 10"

45 x 120 mm



KUEMME  
TS.09.121.33  
33 cm/ 33"



TS.09.123.10  
100 cc



DEEVER-BABY  
20 cm/ 8"

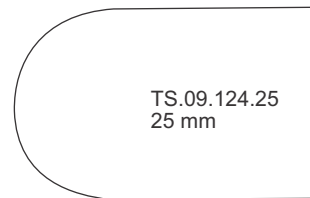

TS.09.124.25  
25 mm

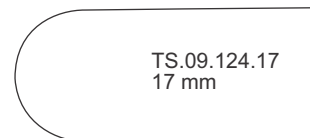

TS.09.124.17  
17 mm



DEAVER  
32 cm / 12½"

TS.09.125.25  
25 mm

TS.09.125.35  
35 mm

TS.09.125.50  
50 mm

TS.09.125.75  
75 mm

# Self-retaining Retractors



Self-retaining Retractors



# Self-retaining Retractors

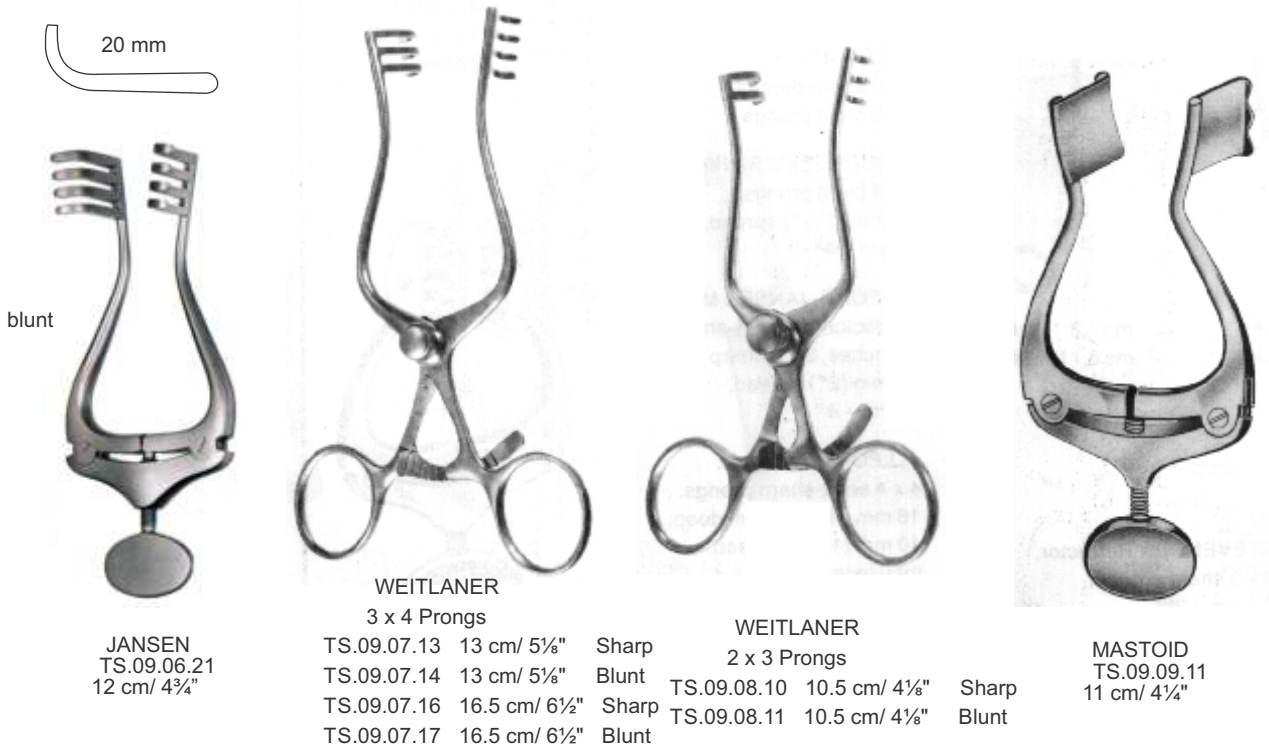
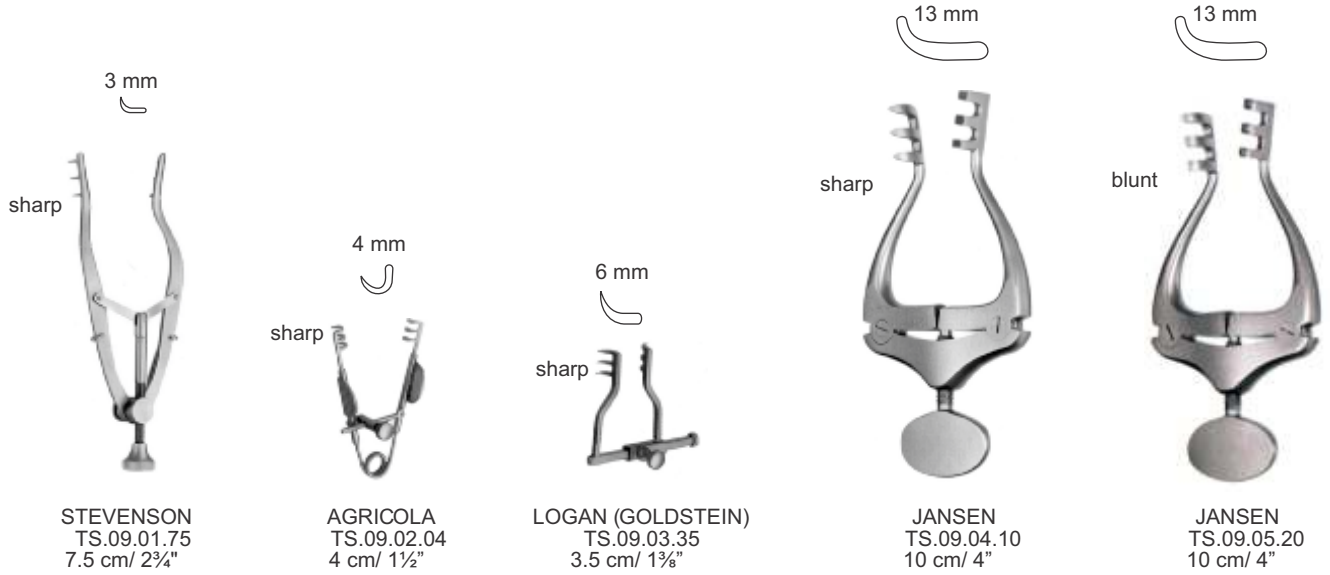

# Self-retaining Retractors

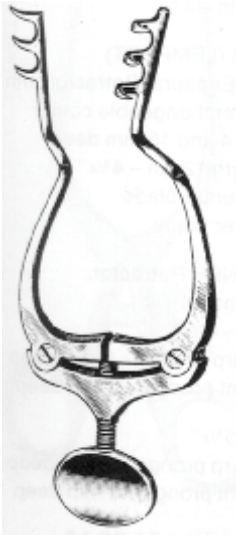

**GIFFORD-JANSEN**  
TS.09.10.10  
10 cm/ 4"  
3 x 3 prongs Sharp



**ALLPORT**  
TS.09.11.10  
10 cm/ 4"  
4 x 4 prongs Semi-Sharp



**SHAMBAUGH**  
TS.09.12.11  
11 cm/ 4¼"

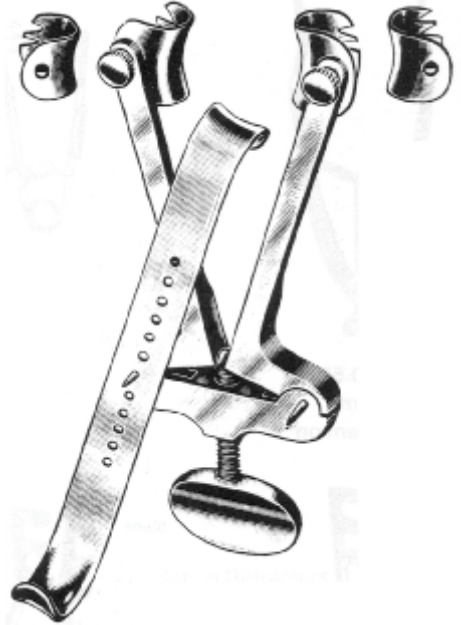

**HENNER (LEMPERT)**  
TS.09.13.12 Without center blade  
TS.09.13.13 With center blade  
12 cm/ 4¾"



sharp

TS.09.14.01 8.5 cm/ 3⅜"  
TS.09.14.02 11.5 cm/ 4½"



TS.09.15.03 8.5 cm/ 3⅜"  
TS.09.15.04 11.5 cm/ 4½"



sharp

TS.09.16.52  
10.5 cm/ 4⅛"



12 mm



sharp  
TS.09.17.05

**FINSEN**  
5 cm/ 2"



12 mm



sharp  
TS.09.18.07

**FINSEN**  
7 cm/ 2¾"



12 mm



sharp  
TS.09.19.07

**FINSEN**  
7 cm/ 2¾"

blunt  
TS.09.18.08

blunt  
TS.09.19.08

# Self-retaining Retractors

6 mm



TS.09.23.09  
sharp

10 cm / 4"

TS.09.23.10  
blunt

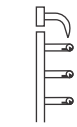

TS.09.24.07  
sharp



ALM  
7 cm / 2¾"



TS.09.24.08  
blunt

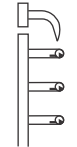

TS.09.25.10  
sharp



ALM  
10 cm / 4"

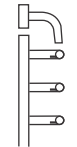

TS.09.25.11  
blunt

20 mm



TS.09.20.20  
sharp

WEITLANER  
20 cm / 8"



TS.09.20.21  
blunt

25 mm



TS.09.21.24  
sharp

WEITLANER  
24 cm / 9½"

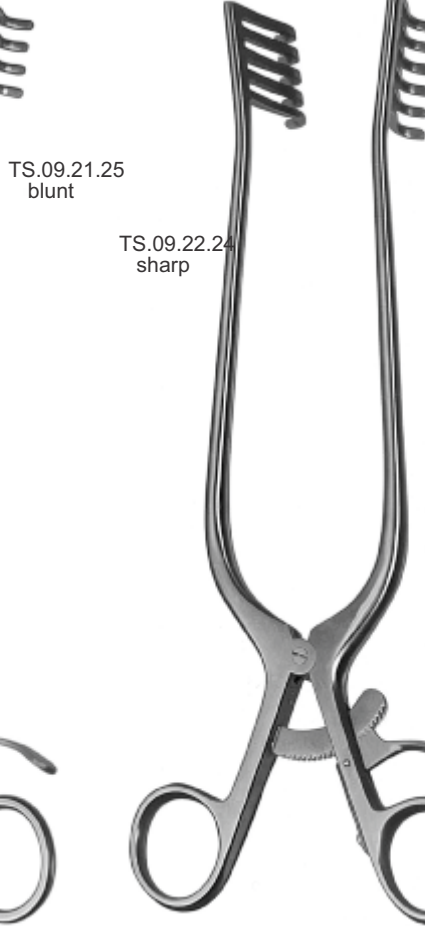

TS.09.21.25  
blunt

25 mm



TS.09.22.24  
sharp

WEITLANER  
25.5 cm / 10"



TS.09.22.27  
blunt

# Self-retaining Retractors



**WEITLANER**  
 TS.09.26.13  
 13 cm / 5 1/8"

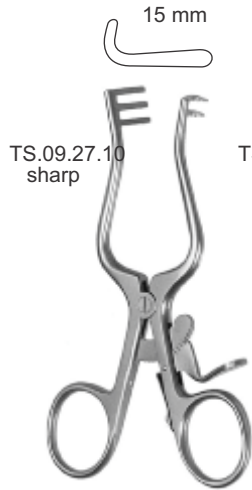

TS.09.27.10  
 sharp

TS.09.28.11 TS.09.28.12  
 blunt semi sharp

**WEITLANER**  
 10.5 cm / 4 1/8"

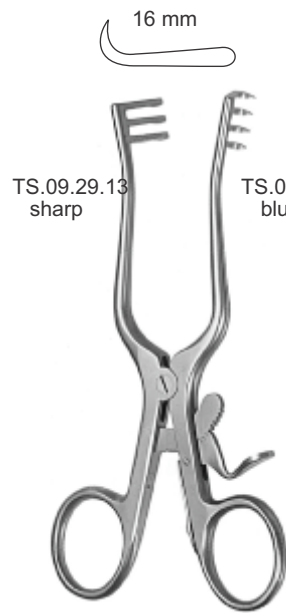

TS.09.29.13  
 sharp

TS.09.30.13 TS.09.30.14  
 blunt semi sharp

**WEITLANER**  
 13 cm / 5 1/8"

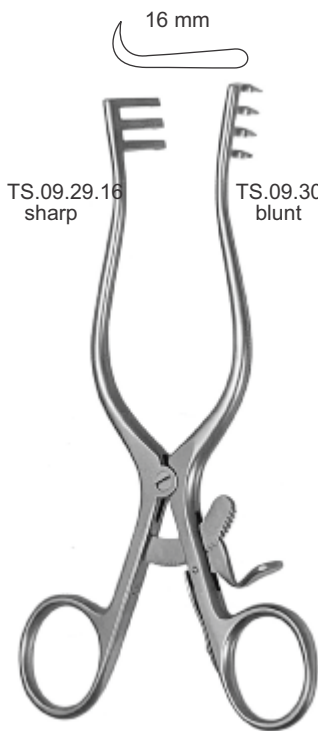

TS.09.29.16  
 sharp

TS.09.30.16 TS.09.30.17  
 blunt semi sharp

**WEITLANER**  
 16 cm / 6 1/2"



**SCHUKNECHT**  
 TS.09.31.13  
 13 cm / 5 1/8"



**SCHUKNECHT**  
 TS.09.32.13  
 13 cm / 5 1/8"

# Self-retaining Retractors



BELLUCCI  
TS.09.32.01  
11 cm/ 4<sup>3</sup>/<sub>8</sub>"



BELLUCCI  
TS.09.32.02  
11 cm/ 4<sup>3</sup>/<sub>8</sub>"



FISH  
TS.09.31.12  
13 cm/ 5<sup>1</sup>/<sub>8</sub>"

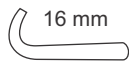

PLESTER  
TS.09.31.21  
11 cm/ 4<sup>3</sup>/<sub>8</sub>"

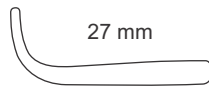

PLESTER  
TS.09.31.22  
12 cm/ 4<sup>3</sup>/<sub>4</sub>"

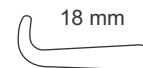

WEITLANER-WULLSTEIN  
13 cm/ 5<sup>1</sup>/<sub>8</sub>"

# Self-retaining Retractors

20 mm



SCHUKNECHT  
 TS.09.31.18  
 13 cm / 5 1/8"

14 mm



MOLLISON  
 TS.09.31.30  
 17 cm / 6 3/4"

18 mm



WEST  
 TS.09.31.35  
 14 cm / 5 1/2"

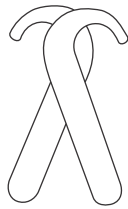

25 mm



TS.09.33.20  
 sharp

TS.09.33.21  
 blunt

ADSON  
 20 cm / 8"

24 mm



ADSON-ANDERSON  
 TS.09.34.19  
 19 cm / 7 1/2"



17.5 cm / 7"

# Self-retaining Retractors

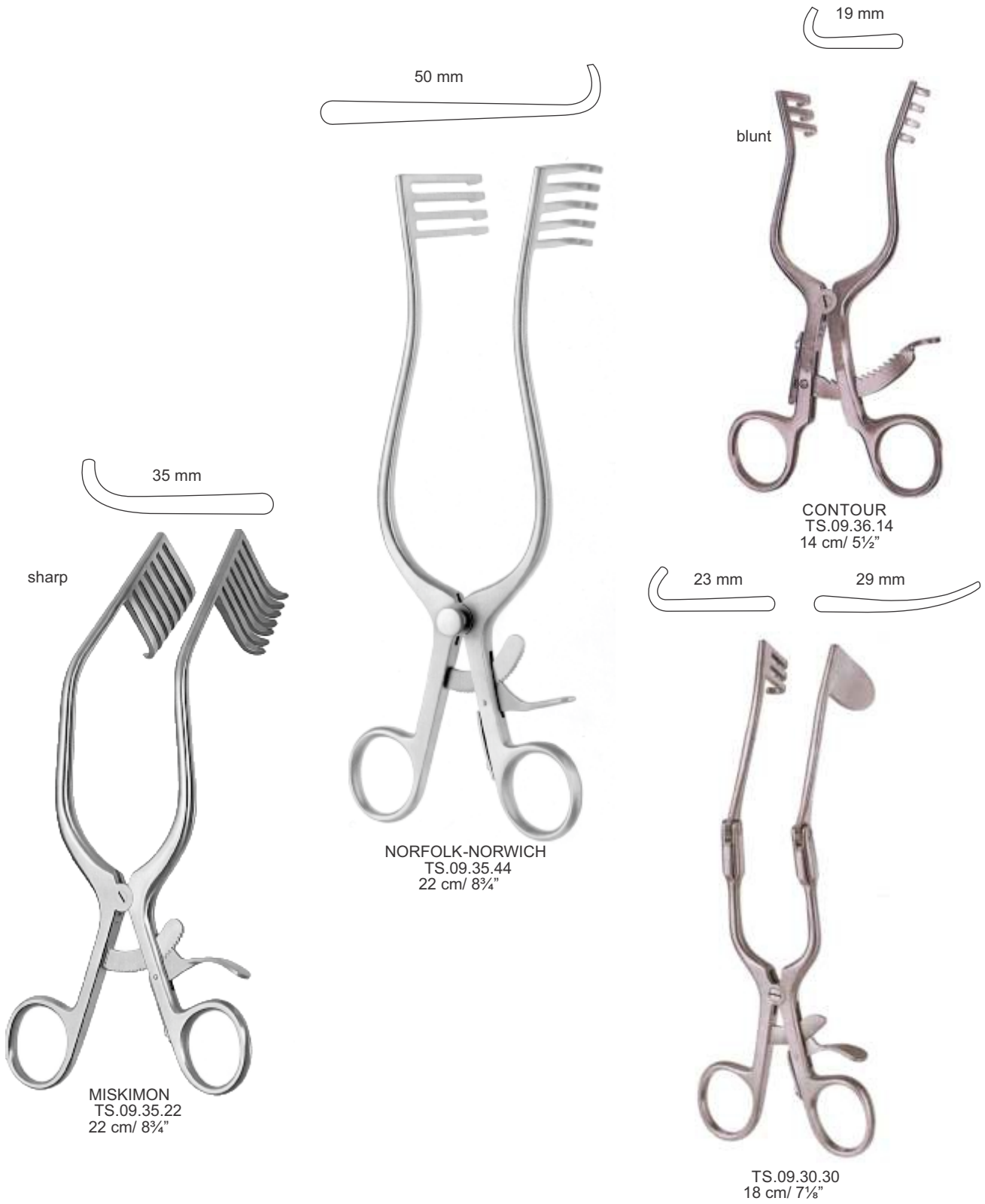

# Self-retaining Retractors

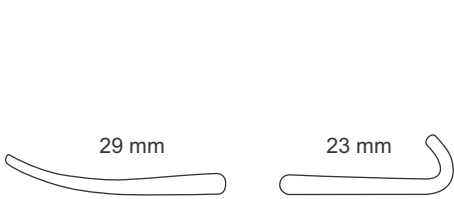

TS.09.30.31  
 18 cm / 7<sup>1</sup>/<sub>8</sub>"



WEITLANER-BECKMANN  
 14.5 cm / 5<sup>3</sup>/<sub>4</sub>"



TRAVERS  
 TS.09.37.22  
 21.5 cm / 8<sup>1</sup>/<sub>2</sub>"

TS.09.37.14  
 blunt

TS.09.37.13  
 sharp



# Self-retaining Retractors

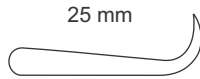

3 x 4 prongs



ADSON  
Retractor  
26.5 cm/ 10½"  
TS.10.38.26 sharp  
TS.10.38.27 blunt

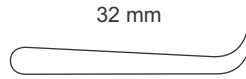

6 x 6 sharp prongs



ADSON  
Hemilaminectomy  
Retractor  
26.5 cm/ 10½"  
TS.10.38.36

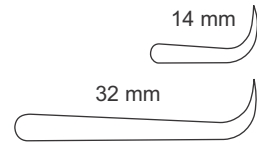

6 x 6 blunt prongs



ADSON  
Hemilaminectomy  
Retractor  
26.5 cm/ 10½"  
TS.10.38.37  
left 14 mm  
right 32 mm

# Self-retaining Retractors



1/2  
**ADSON**  
 3 x 4 teeth

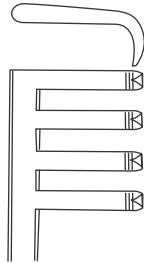

TS.10.39.13  
 sharp  
 13 cm - 5"

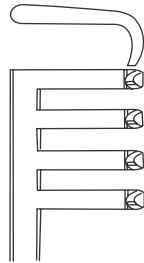

TS.10.39.14  
 blunt  
 13 cm - 5"

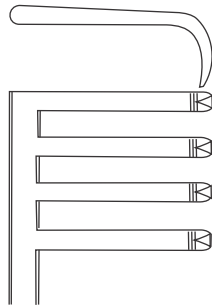

TS.10.39.26  
 sharp  
 26 cm - 10 1/4"

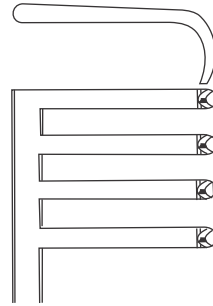

TS.10.39.27  
 blunt  
 26 cm - 10 1/4"

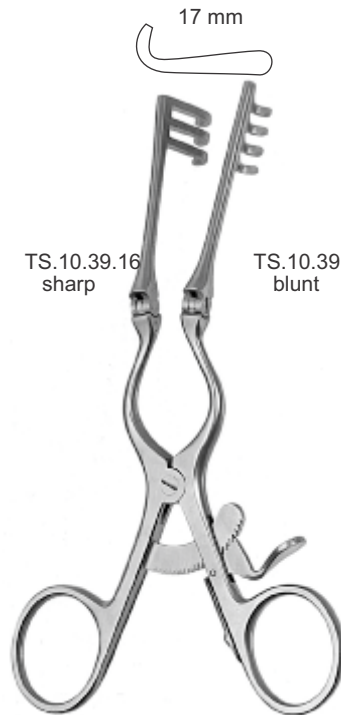

TS.10.39.16  
 sharp

TS.10.39.17  
 blunt

**WEITLANER-BECKMANN**  
 17 cm / 6 3/4"



TS.10.39.20  
 sharp

TS.10.39.21  
 blunt

**WEITLANER-BECKMANN**  
 22 cm / 8 3/4"

# Self-retaining Retractors

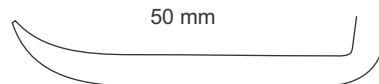

BECKMANN  
TS.10.40.31  
31 cm / 12 $\frac{1}{8}$ "



ADSON  
TS.10.40.32  
32.5 cm / 12 $\frac{3}{4}$ "



BECKMANN-EATON  
TS.10.40.62  
32 cm / 12 $\frac{1}{2}$ "

# Self-retaining Retractors



BECKMANN-ADSON  
 31 cm / 12 1/4"  
 4 x 4 teeth

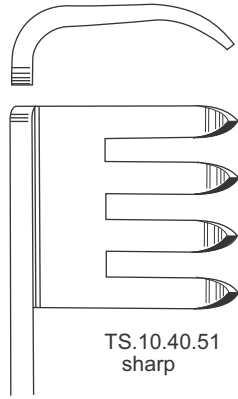

TS.10.40.51  
 sharp

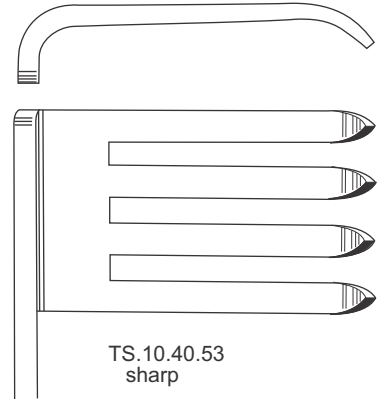

TS.10.40.53  
 sharp

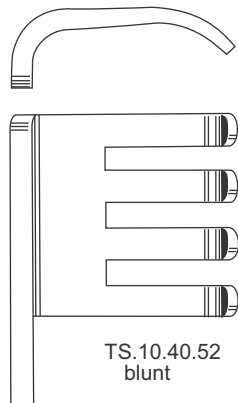

TS.10.40.52  
 blunt

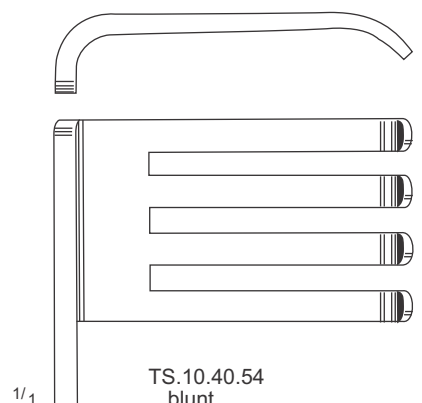

1/1  
 TS.10.40.54  
 blunt

# Self-retaining Retractors

sharp prongs



**KOCHER**  
TS.10.41.16  
16 cm/ 6¼"

sharp prongs



**CROTTI**  
TS.10.42.18  
18 cm/ 7"



**GELPI BABY**  
TS.10.43.10  
10 cm/ 4"



**GELPI-BABY**  
PY-43.14  
14 cm/ 5½"



**GELPI**  
PY-44.17  
17 cm/ 6¾"



**GELPI**  
PY-45.17  
19 cm/ 7½"

# Self-retaining Retractors



RIGBY  
 PY-46.18  
 18 cm / 7 1/8"



Lateral blade  
 16 x 30 mm

MAYO-ADAMS  
 PY-47.17  
 17 cm / 6 3/4"

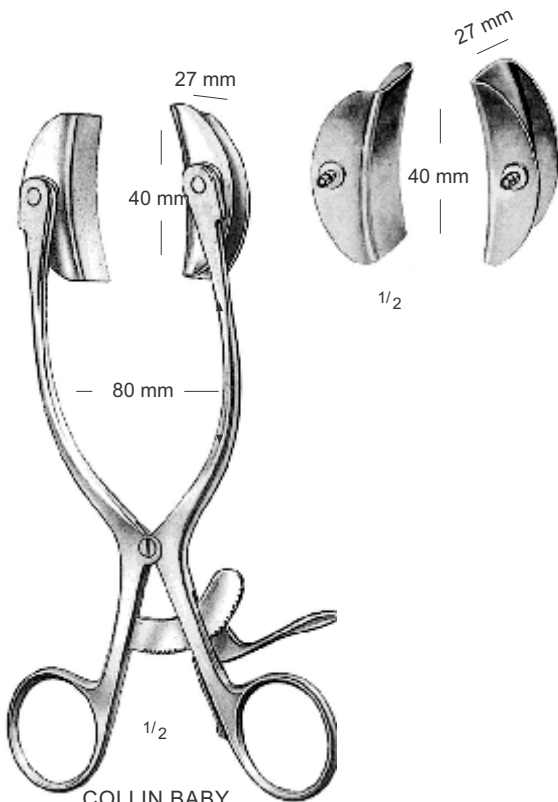

COLLIN BABY  
 TS.10.48.00  
 complete with two pair of blades



MAYO-ADAMS  
 PY-47.18  
 17 cm / 6 3/4"

# Self-retaining Retractors



MARKHAM-MEYERDING  
TS.10.49.18  
18 cm/ 7 $\frac{1}{8}$ "



MARKHAM-MEYERDING  
TS.10.50.18  
18 cm/ 7 $\frac{1}{8}$ "



DARTIGUES  
TS.10.51.65  
24 cm/ 9 $\frac{1}{2}$ "

max. spread 110 mm



TS.10.52.16  
40 x 18 mm  
Lateral Blades only (Pair)

max. spread 80 mm

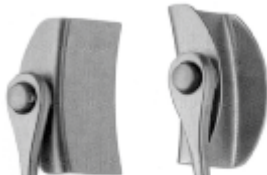

TS.10.52.28  
40 x 28 mm  
Lateral Blades only (Pair)



COLLIN-BABY  
TS.10.52.07  
18 cm/ 7 $\frac{1}{8}$ "

TS.10.52.18  
Frame only

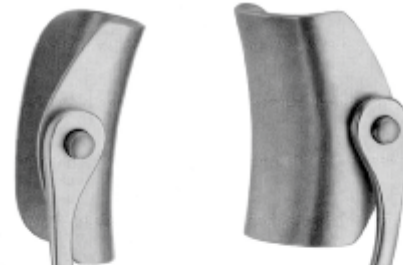

TS.10.48.62  
62 x 38 mm  
Lateral Blades only (Pair)



COLLIN  
TS.10.48.24  
23.5 cm/ 9 $\frac{1}{4}$ "

TS.10.48.23  
Frame only

# Self-retaining Retractors

max. spread 110 mm



TS.10.55.36  
 Frame only

TS.10.55.38 62 x 38 mm  
 TS.10.54.39 80 x 38 mm  
 TS.10.55.39 100 x 38 mm  
 Lateral blades only (Pair)

TS.10.55.40 55 x 40 mm  
 TS.10.55.56 65 x 55 mm  
 TS.10.55.58 75 x 55 mm  
 Center blade only

**COLLIN**  
 23.5 cm/ 9¼"

- |                 |                 |                 |
|-----------------|-----------------|-----------------|
| TS.10.54.00     | TS.10.54.01     | TS.10.54.02     |
| 1 x TS.10.55.38 | 1 x TS.10.54.39 | 1 x TS.10.55.39 |
| 1 x TS.10.55.40 | 1 x TS.10.55.56 | 1 x TS.10.55.58 |
| 1 x TS.10.55.36 | 1 x TS.10.55.36 | 1 x TS.10.55.36 |



**MEYERDING**  
 18 cm/ 7"  
 TS.10.53.30 25 x 30 mm  
 TS.10.53.55 25 x 55 mm  
 TS.10.53.60 25 x 60 mm  
 TS.10.53.61 20 x 60 mm



# Self-retaining Retractors



OETTINGEN  
TS.10.54.70

# Self-retaining Retractors

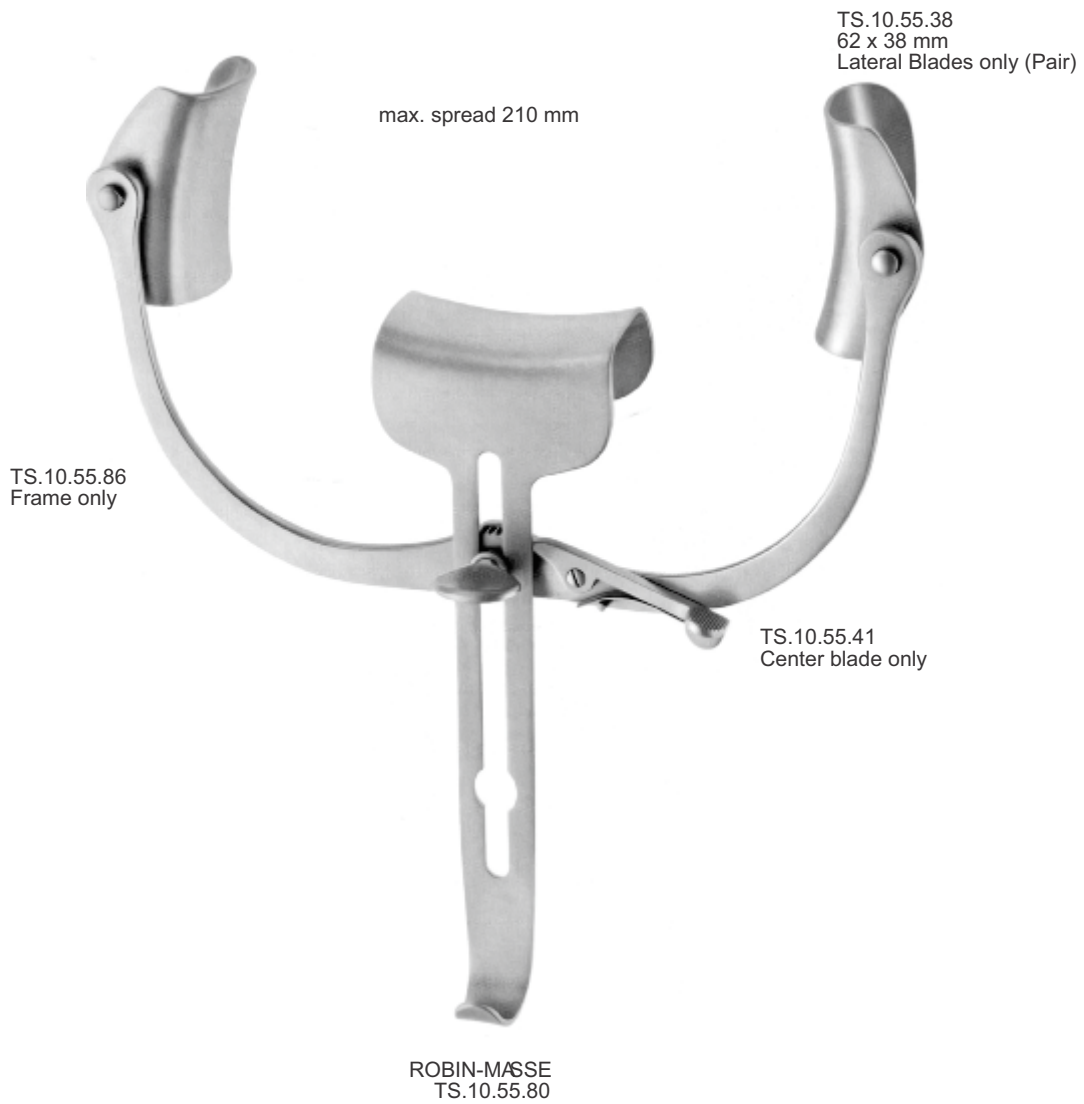

# Self-retaining Retractors



max. spread 165 mm

TS.10.56.60 58 x 50 mm  
TS.10.56.62 80 x 62 mm  
Lateral Blades only (Pair)

TS.10.56.56  
Frame only

TS.10.56.70  
Center blade only

COLLIN  
TS.10.56.50  
32 cm/ 12½"

TS.10.56.51  
33 cm/ 13"

# Self-retaining Retractors



TS.10.57.09  
Frazier



TS.10.58.12  
Temple-Fay

# Self-retaining Retractors

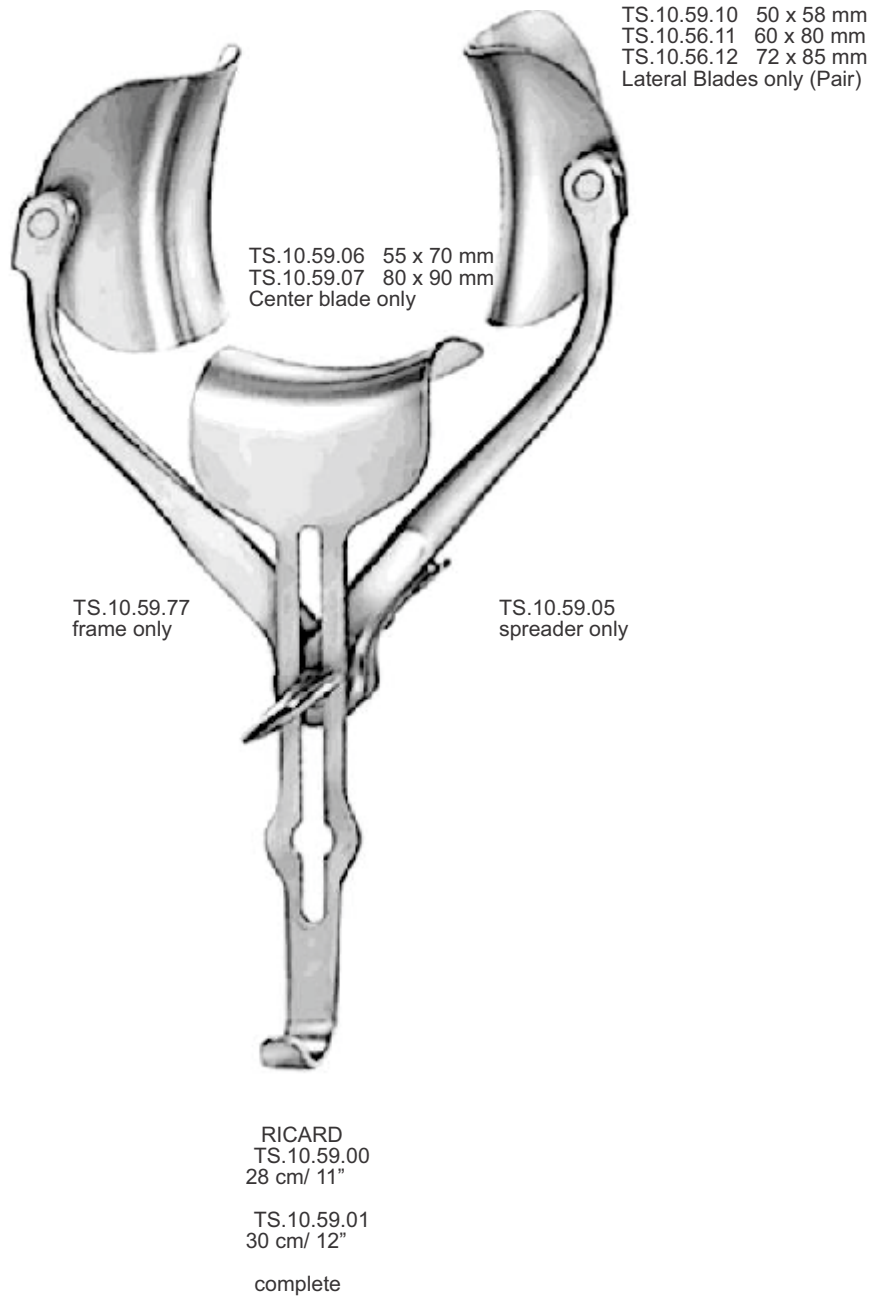

# Self-retaining Retractors

max. spread 115 mm

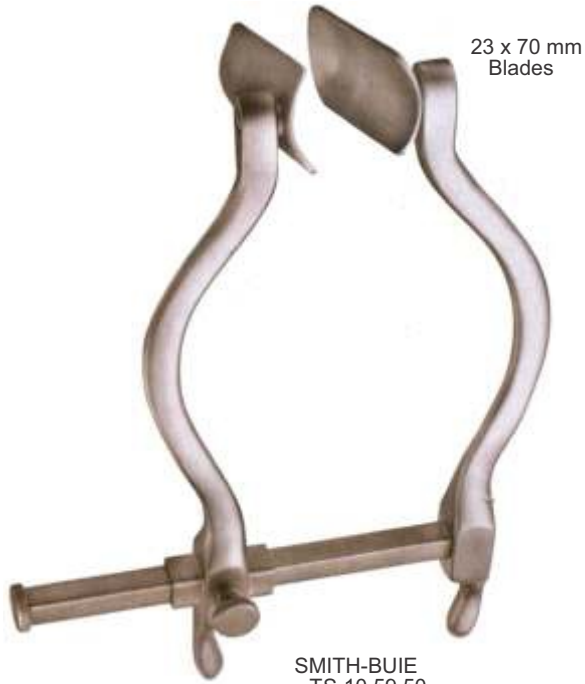

SMITH-BUIE  
TS.10.59.50

23 x 70 mm  
Blades

TS.10.60.10  
max. spread 105 mm  
Lateral blades 18 mm



REHBEIN

TS.10.60.11  
max. spread 115 mm  
Lateral blades 25 mm

max. spread 80 mm



GOSSET-BABY  
TS.10.60.01

Lateral blades 38 mm

# Self-retaining Retractors

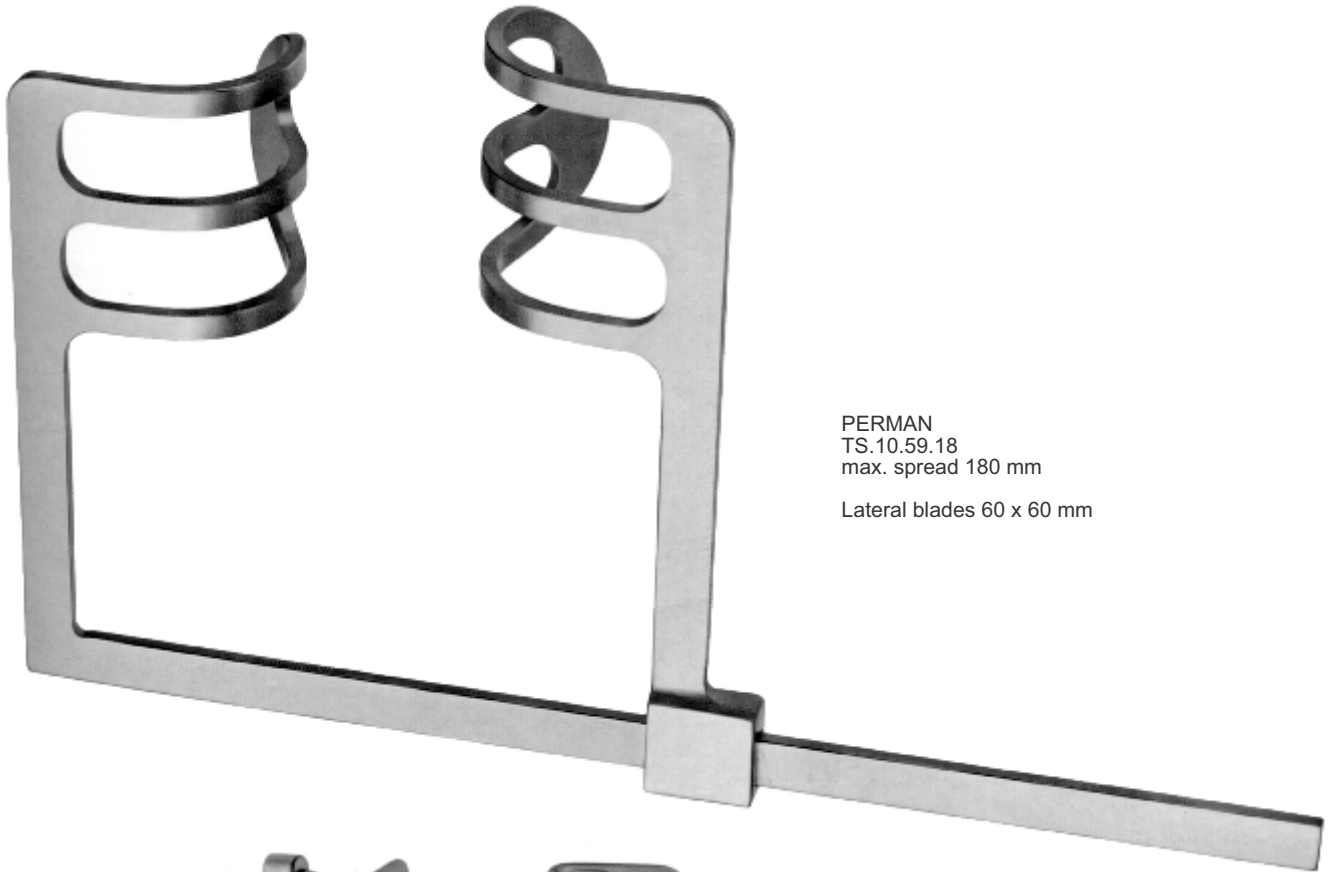

PERMAN  
TS.10.59.18  
max. spread 180 mm

Lateral blades 60 x 60 mm



GOSSET  
TS.10.61.15  
max. spread 115 mm

Lateral blades 55 mm

# Self-retaining Retractors



TS.10.66.02  
Center blade 24 x 24 mm

TS.10.74.10  
center blade 24 x 24 mm



TS.10.64.25  
Center blade 25 x 75 mm





# Self-retaining Retractors



TS.10.73.30 30 x 60mm  
TS.10.73.45 30 x 45mm



TS.10.73.43 43 x 60mm  
TS.10.73.54 43 x 45mm



TS.10.73.58 58 x 60mm



TS.10.76.41  
80 x 80 mm



TS.10.77.33  
90 mm  
Lateral blades only (Pair)

max. spread 180 mm



TS.10.77.10  
75 mm  
Lateral blades only (Pair)

TS.10.77.30  
Frame only

TS.10.75.20  
63 x 38 mm  
Center blade only

BALFOUR-MEDICON  
TS.10.77.00

# Self-retaining Retractors



max. spread 200 mm

TS.10.77.42  
60 mm  
Lateral blades only (Pair)

TS.10.77.41  
Frame only

TS.10.75.30  
75 x 50 mm  
Center blade only

BALFOUR-MEDICON  
TS.10.77.40



TS.10.77.43  
110 mm  
Lateral blades only (Pair)



TS.10.80.75  
70 x 100 mm  
Center blade only

# Self-retaining Retractors



ULRICH-ST. GALLEN  
TS.10.65.05



ULRICH-ST. GALLEN  
TS.10.65.10  
TS.10.65.11



SCOVILLE-RICHTER  
TS.10.68.15

TS.10.75.30  
Center blade 75 x 50 mm



BALFOUR  
TS.10.69.10  
max. spread 180 mm

Lateral blades 65 mm  
Center blade 75 x 50 mm

# Self-retaining Retractors

TS.10.76.40  
 Center blade 85 x 65 mm



BALFOUR  
 TS.10.70.15  
 max. spread 180 mm  
 Lateral blades 100 mm  
 Center blade 85 x 65 mm

BALFOUR  
 TS.10.70.17  
 max. spread 250 mm  
 Lateral blades 100 mm  
 Center blade 85 x 65 mm

TS.10.75.30  
 Center blade 75 x 50 mm



BALFOUR  
 TS.10.71.11  
 max. spread 180 mm  
 Lateral blades 30 x 60 mm  
 Center blade 75 x 50 mm



ULRICH-ST. GALLEN  
 TS.10.72.16



TS.10.73.32  
 32 x 90 mm



TS.10.73.35  
 30 x 60 mm

# Self-retaining Retractors

TS.10.79.25  
30 x 40 mm  
blade only

TS.10.79.26  
40 x 40 mm  
blade only

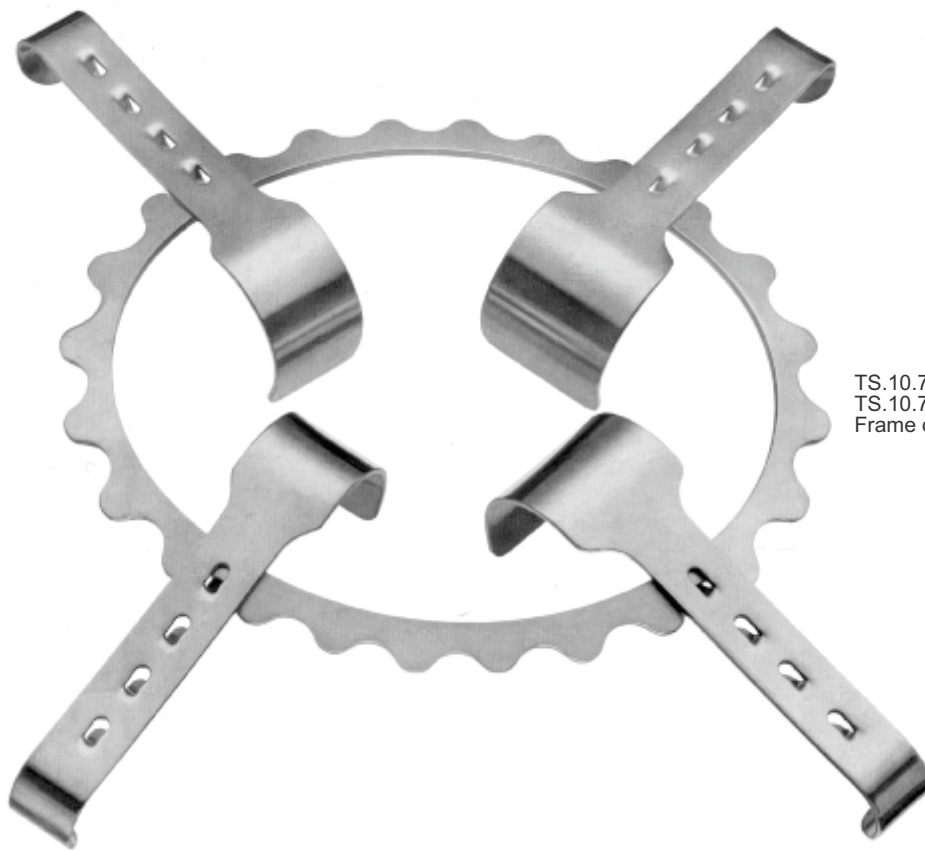

TS.10.79.11 180 x 150 mm  
TS.10.79.12 225 x 180 mm  
Frame only

DENIS BROWNE  
TS.10.79.01  
2 x TS.10.79.25  
2 x TS.10.79.26  
1 x TS.10.79.11

TS.10.79.02  
2 x TS.10.79.25  
2 x TS.10.79.26  
1 x TS.10.79.12

# Self-retaining Retractors

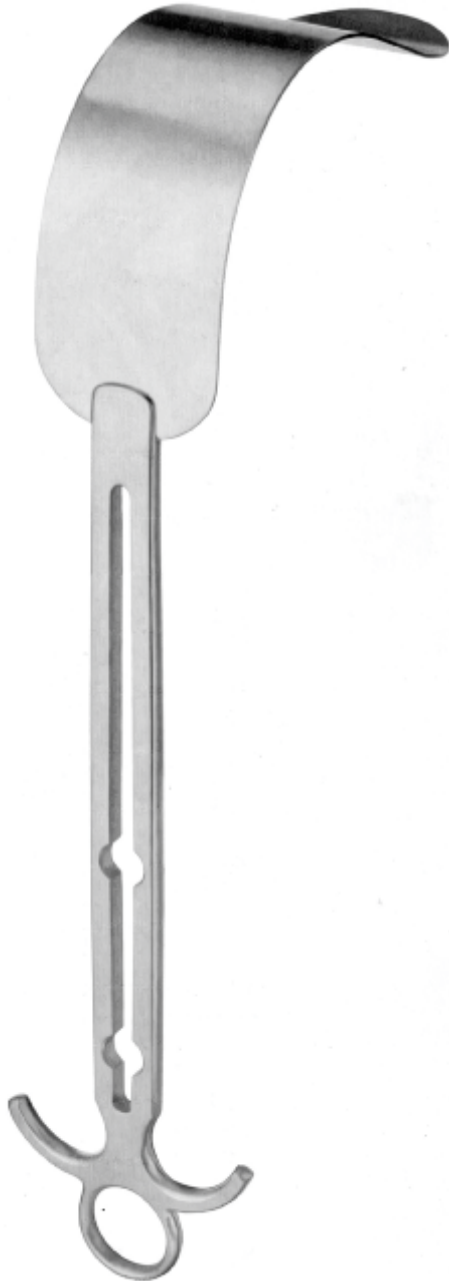

TS.10.81.85  
50 x 125 mm

TS.10.78.50  
Center blade 70 x 100 mm

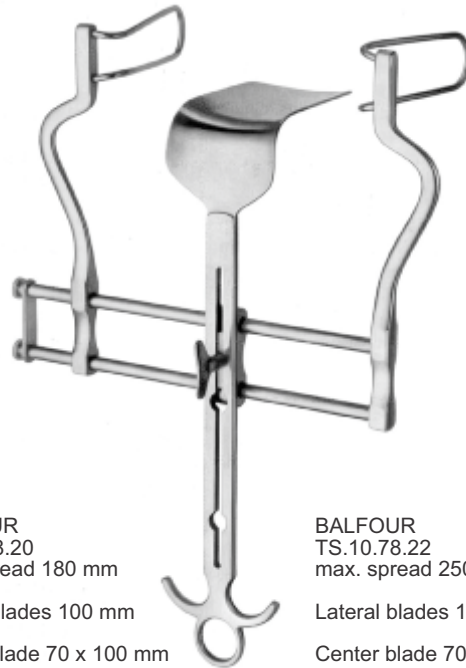

BALFOUR  
TS.10.78.20  
max. spread 180 mm  
Lateral blades 100 mm  
Center blade 70 x 100 mm

BALFOUR  
TS.10.78.22  
max. spread 250 mm  
Lateral blades 100 mm  
Center blade 70 x 100 mm

# Self-retaining Retractors

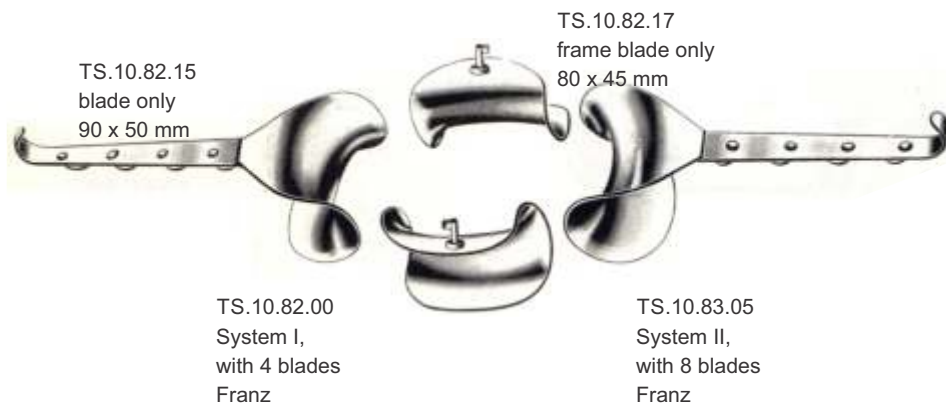

# Self-retaining Retractors



KIRSCHNER  
TS.10.84.05

1 x TS.10.86.06  
2 x TS.10.85.14  
2 x TS.10.85.15

TS.10.84.06  
270 x 270 mm  
Frame only



TS.10.85.16 80 x 65 mm  
TS.10.85.18 65 x 80 mm



TS.10.85.19  
90 x 85 mm



# Self-retaining Retractors

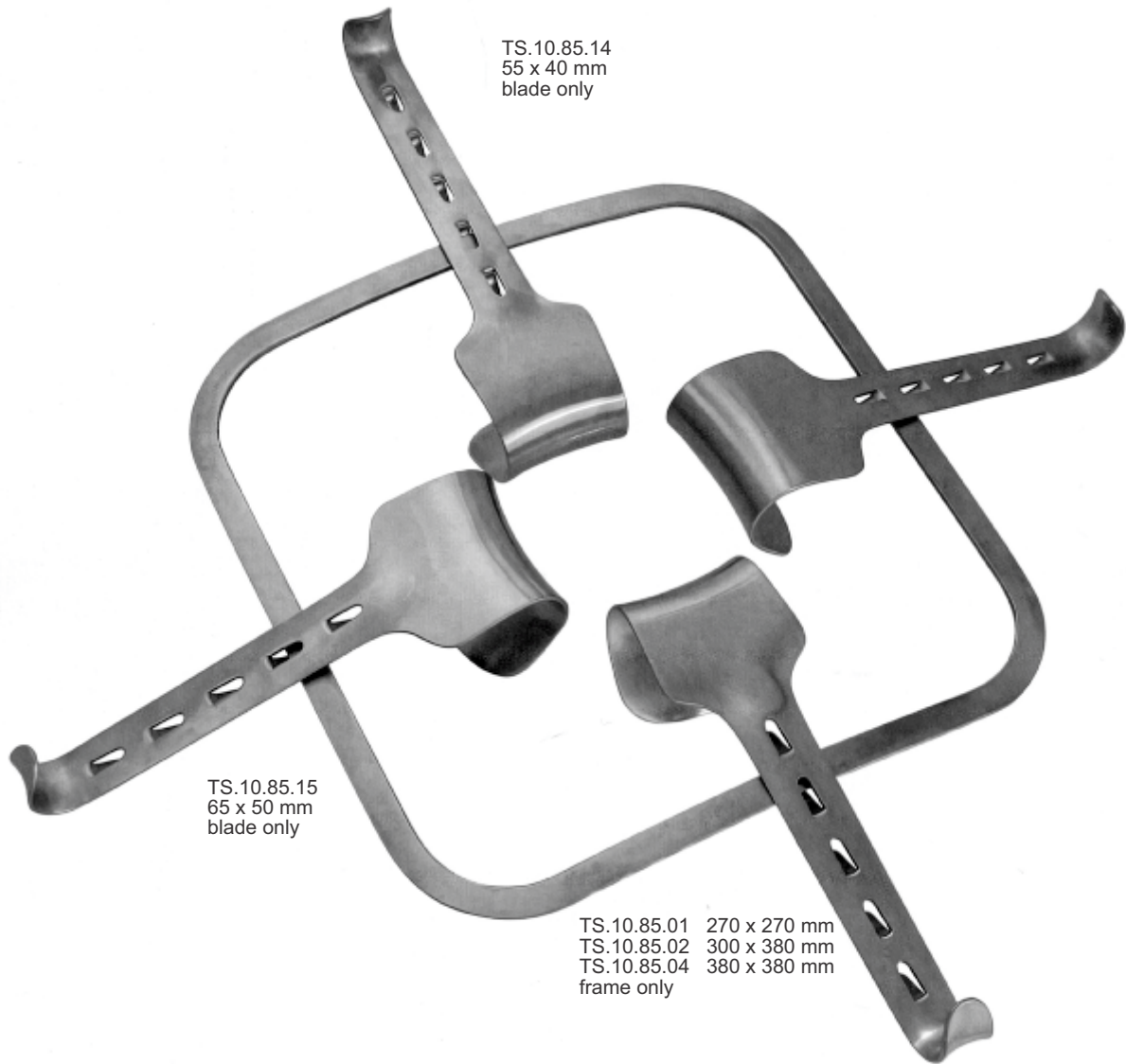

TS.10.85.14  
55 x 40 mm  
blade only

TS.10.85.15  
65 x 50 mm  
blade only

TS.10.85.01 270 x 270 mm  
TS.10.85.02 300 x 380 mm  
TS.10.85.04 380 x 380 mm  
frame only

TS.10.85.00  
2 x TS.10.85.14  
2 x TS.10.85.15  
1 x TS.10.85.01

TS.10.85.03  
2 x TS.10.85.14  
2 x TS.10.85.15  
1 x TS.10.85.04

KIRSCHNER

# Self-retaining Retractors

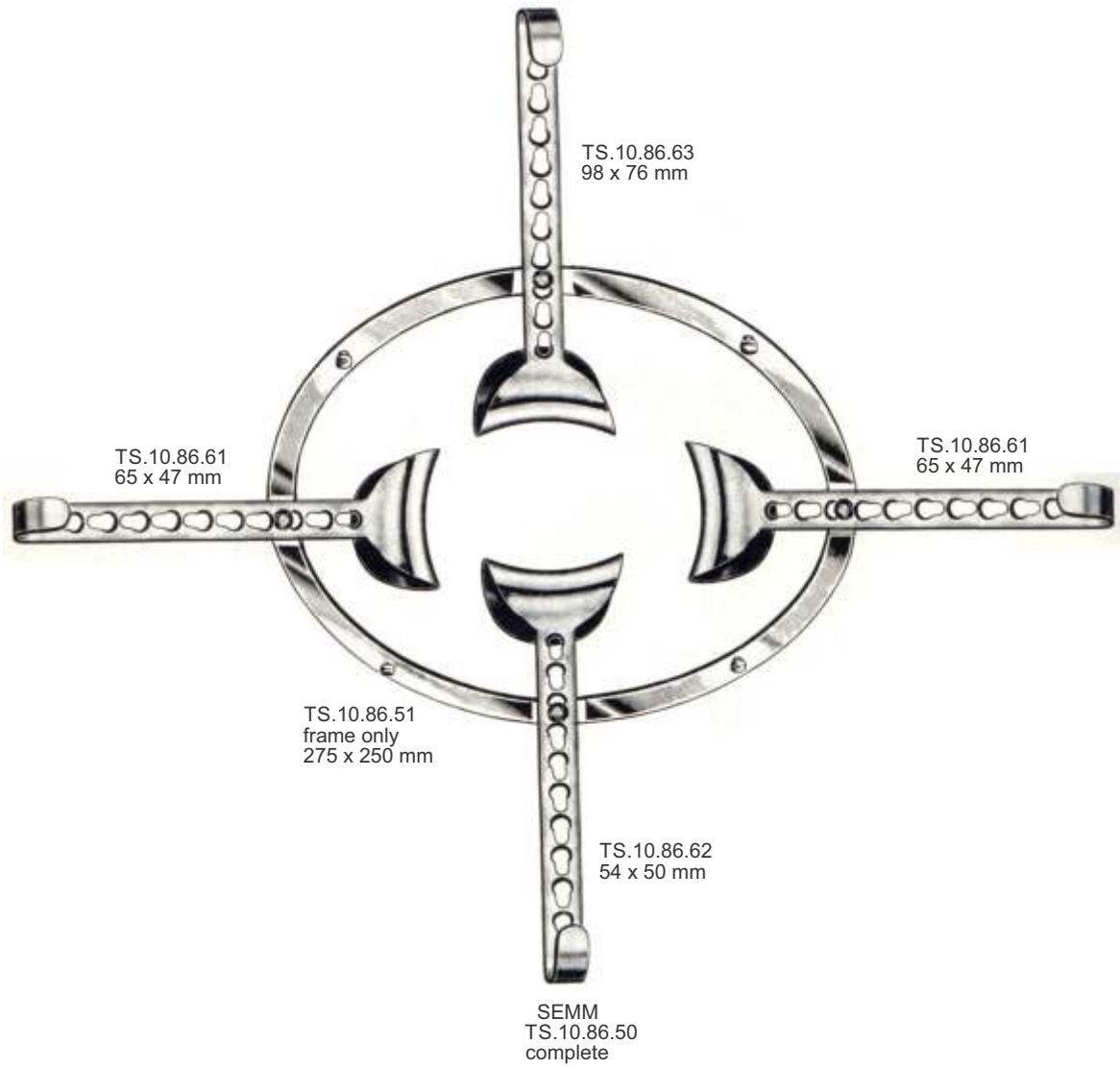

# Self-retaining Retractors



TS.10.86.44  
50 x 98 mm  
blade only



TS.10.86.45  
35 x 105 mm  
blade only



TS.10.86.43  
94 x 83 mm  
blade only



TS.10.86.41  
57 x 45 mm  
blade only

TS.10.86.41  
57 x 45 mm  
blade only

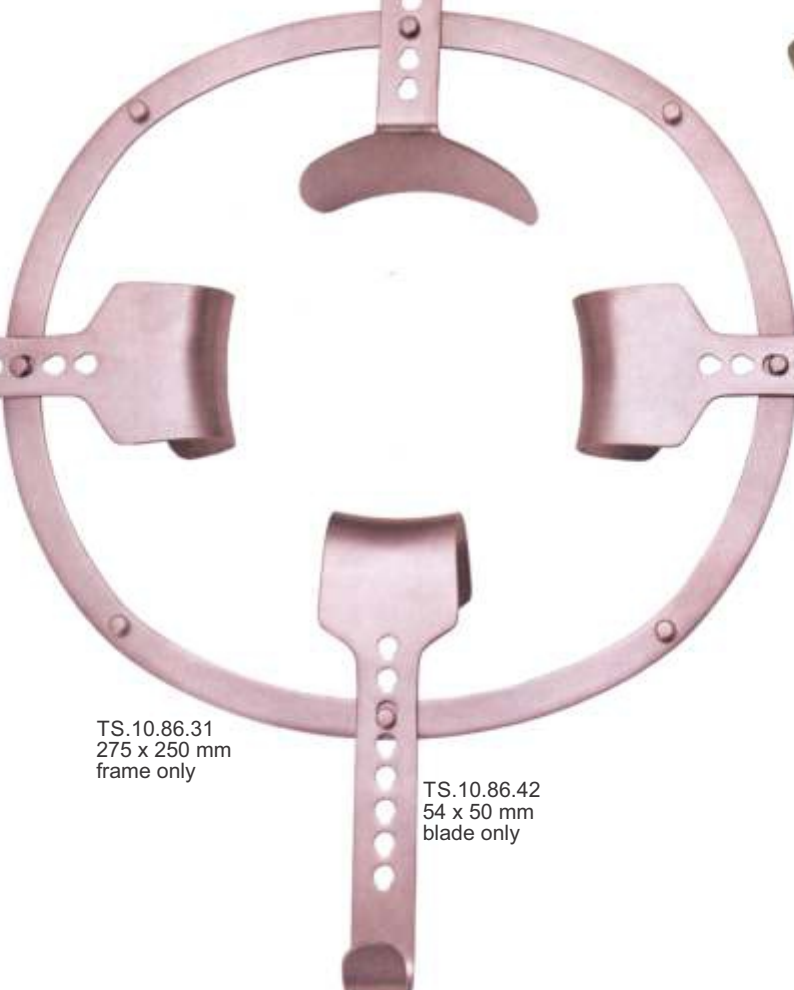

TS.10.86.31  
275 x 250 mm  
frame only



TS.10.86.42  
54 x 50 mm  
blade only

SEMM  
TS.10.86.00  
1 x TS.10.86.42 - TS.10.86.45  
2 x TS.10.86.41  
1 x TS.10.86.31

# Self-retaining Retractors



DOYEN  
TS.10.87.01 95 x 60 mm  
TS.10.87.02 105 x 65 mm  
TS.10.87.03 115 x 65 mm  
TS.10.87.04 125 x 65 mm  
29 cm / 11½"



ROCHARD  
TS.10.88.01 95 x 60 mm  
TS.10.88.02 105 x 65 mm  
TS.10.88.03 115 x 65 mm  
TS.10.88.04 135 x 65 mm  
TS.10.88.05 155 x 65 mm  
29 cm / 11½"

# Self-retaining Retractors

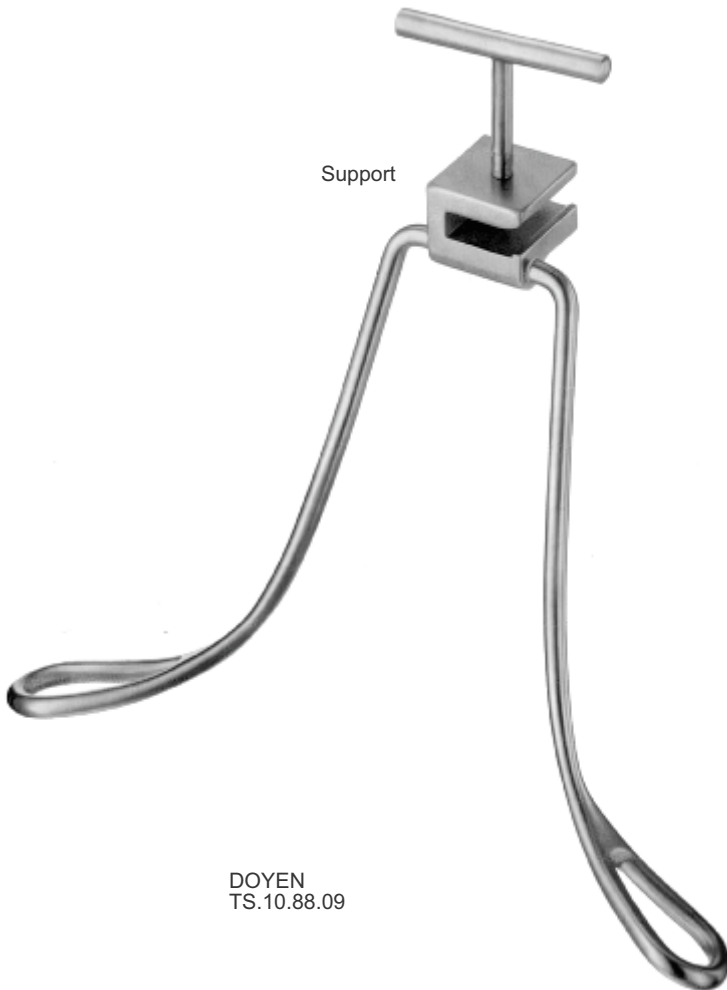

DOYEN  
TS.10.88.09

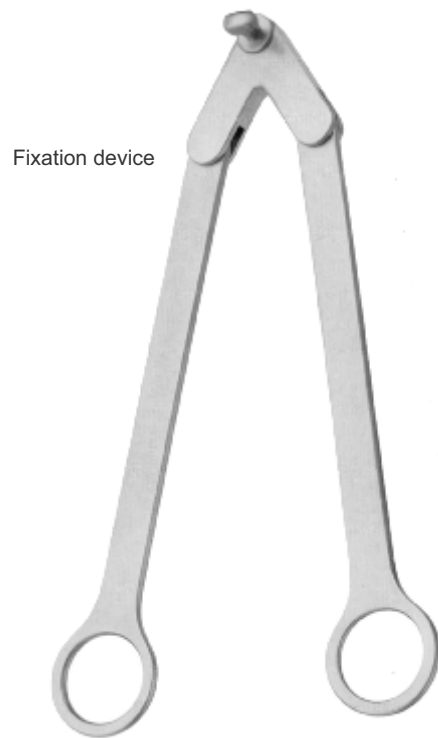

ROCHARD  
TS.10.88.19  
19 cm / 7½"

# Self-retaining Retractors

with 2 rotatable blades 25 x 60 mm



TS.10.90.09  
Frame only

O'SULLIVAN-O'CONNOR  
TS.10.90.00

2 x TS.10.90.11  
1 x TS.10.90.12  
1 x TS.10.90.09



TS.10.90.11  
45 x 85 mm  
Blade only



TS.10.90.12  
70 x 105 mm  
Blade only

# Self-retaining Retractors

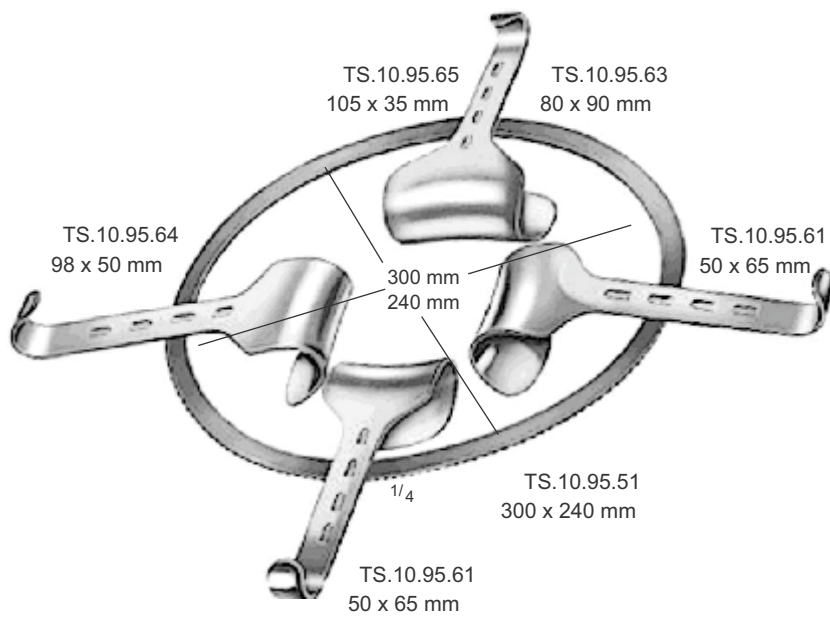

## KIRSCHNER

TS.10.95.00

Complete consisting of

- |             |   |                                |
|-------------|---|--------------------------------|
| TS.10.95.51 | 1 | Frame, 300 x 240 mm            |
| TS.10.95.61 | 3 | Hook-on retractors, 50 x 65 mm |
| TS.10.95.63 | 1 | Retractor, 80 x 90 mm          |
| TS.10.95.64 | 1 | Retractor, 98 x 50 mm          |
| TS.10.95.65 | 1 | Retractor, 105 x 35 mm         |

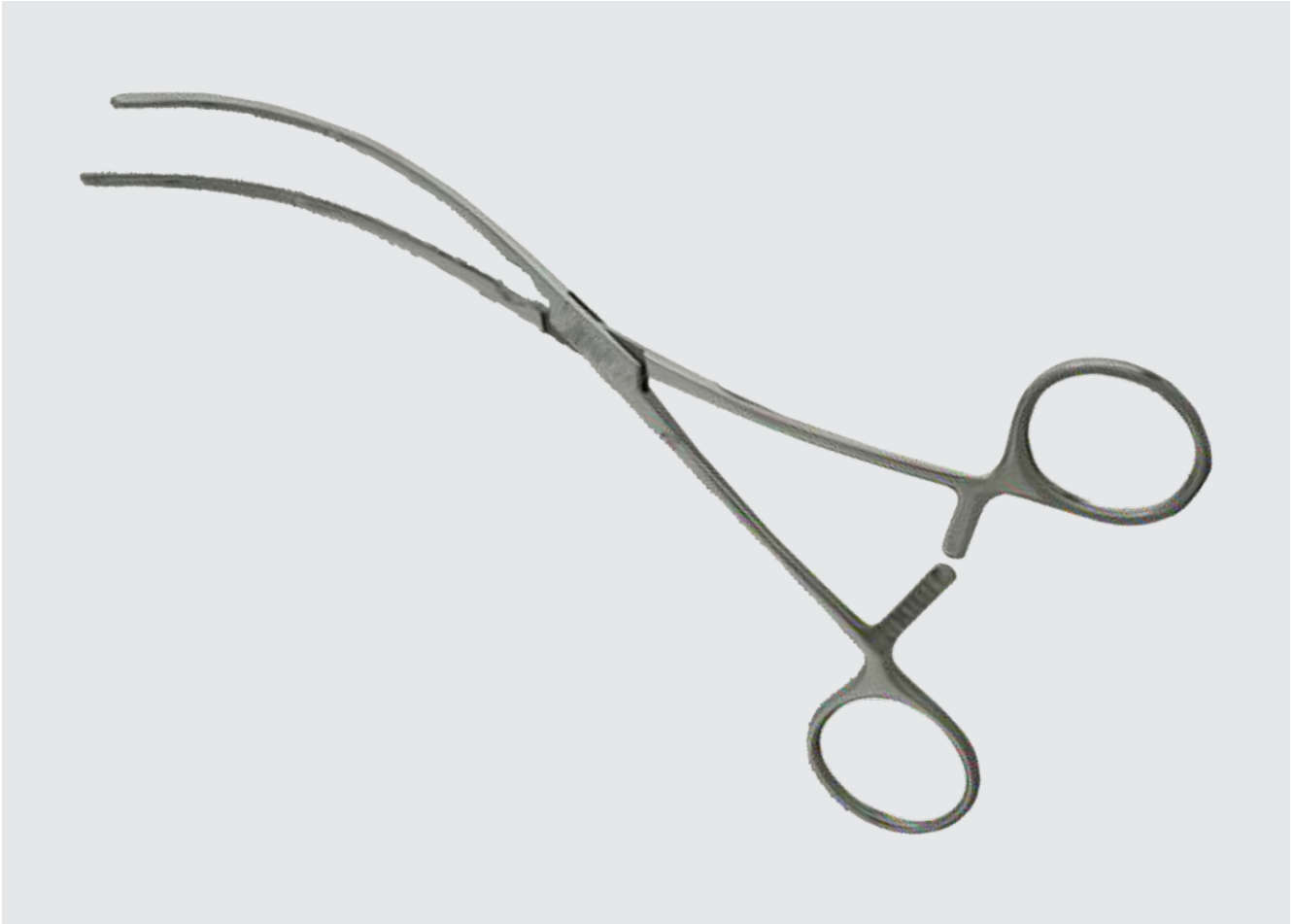

Cardiovascular Instruments



# Cardiovascular Instruments

## Bulldog clamps



DEBAKEY "AT"

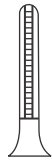

TS.10.01.75  
7.5 cm / 3"

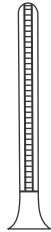

TS.10.01.85  
8.5 cm / 3<sup>1</sup>/<sub>6</sub>"

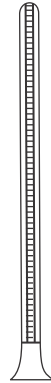

TS.10.01.90  
10.5 cm / 4<sup>1</sup>/<sub>6</sub>"

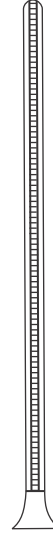

TS.10.01.92  
12 cm / 4<sup>3</sup>/<sub>4</sub>"

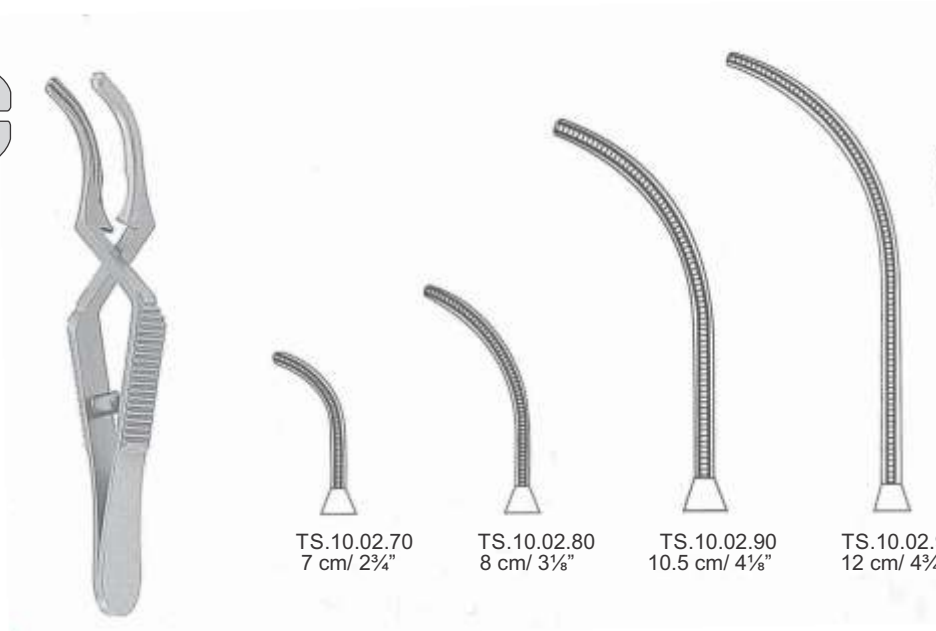

DEBAKEY "AT"



TS.10.02.70  
7 cm / 2<sup>3</sup>/<sub>4</sub>"



TS.10.02.80  
8 cm / 3<sup>1</sup>/<sub>6</sub>"



TS.10.02.90  
10.5 cm / 4<sup>1</sup>/<sub>6</sub>"



TS.10.02.95  
12 cm / 4<sup>3</sup>/<sub>4</sub>"

# Cardiovascular Instruments



GLOVER "AT"

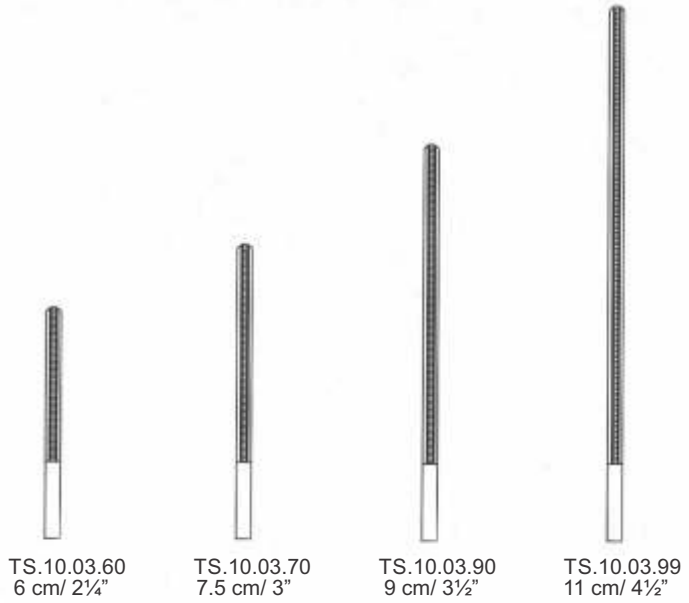

GLOVER "AT"

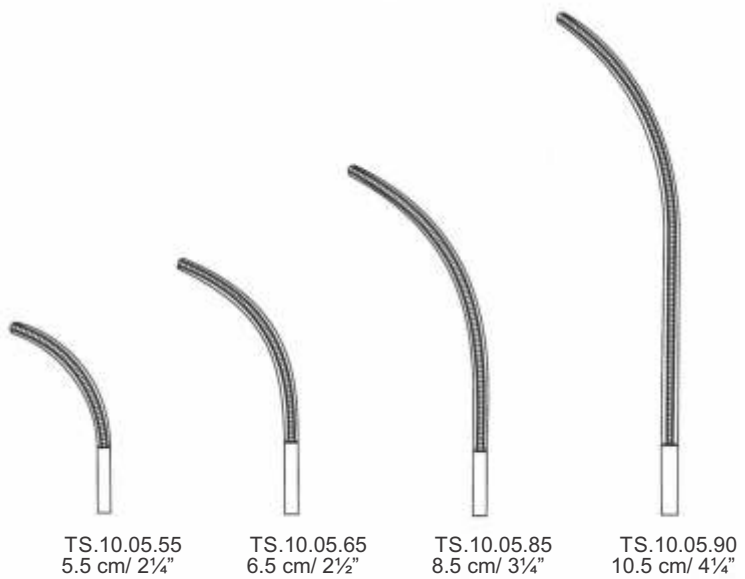

# Cardiovascular Instruments



DE BAKEY

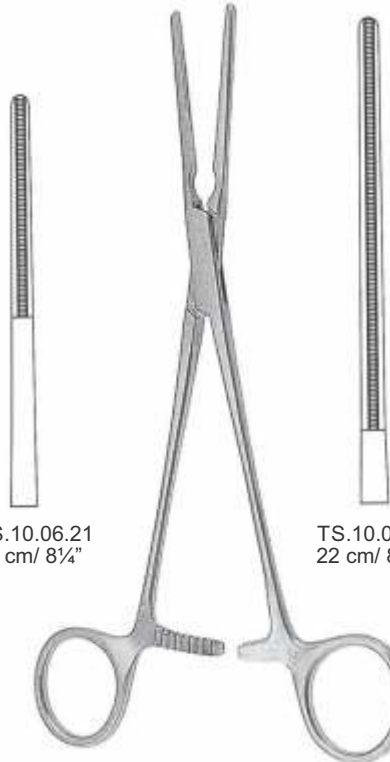

TS.10.06.21  
21 cm/ 8¼"

TS.10.06.22  
22 cm/ 8¾"

POTTS  
Coarctation Clamps



TS.10.07.21  
21 cm/ 8¼"

TS.10.07.22  
22 cm/ 8¾"

POTTS  
Coarctation Clamps



TS.10.08.21  
21 cm/ 8¼"

TS.10.08.22  
22 cm/ 8¾"

POTTS  
Coarctation Clamps

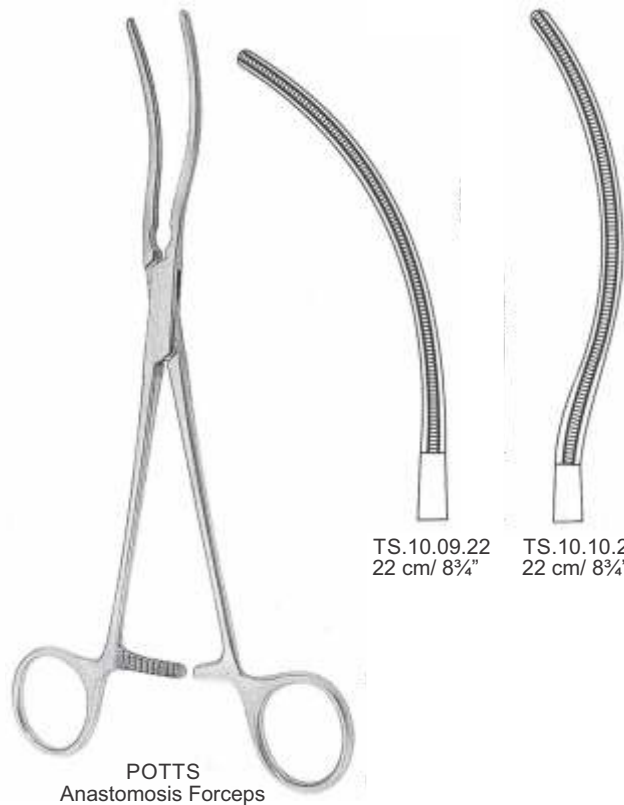

TS.10.09.22  
22 cm/ 8¾"

TS.10.10.22  
22 cm/ 8¾"

POTTS  
Anastomosis Forceps

# Cardiovascular Instruments



DE BAKEY



DE BAKEY  
Dissecting and Ligature Forceps



TS.10.11.19  
19 cm / 7½"



TS.10.12.23  
23 cm / 9"



TS.10.13.16  
16 cm / 6¼"

DE BAKEY  
Peripheral Vascular Clamps



DE BAKEY  
Peripheral Vascular Clamps



TS.10.14.19  
19 cm / 7½"



TS.10.14.20  
20 cm / 8"

# Cardiovascular Instruments



DE BAKEY



LELAND-JONES  
Peripheral Vascular Clamps

TS.10.15.18  
18 cm / 7 1/8"

TS.10.15.19  
19 cm / 7 1/2"

TS.10.15.20  
20 cm / 8"



BAINBRIDGE  
Peripheral Vascular Clamps

TS.10.16.15  
15 cm / 6"

TS.10.16.18  
18 cm / 7 1/8"

TS.10.17.15  
15 cm / 6"

TS.10.17.18  
18 cm / 7 1/8"



DE BAKEY  
Renal Artery Clamps

TS.10.18.20  
20 cm / 8"

# Cardiovascular Instruments



DE BAKEY



DE BAKEY  
 Aortic Aneurysm Clamps

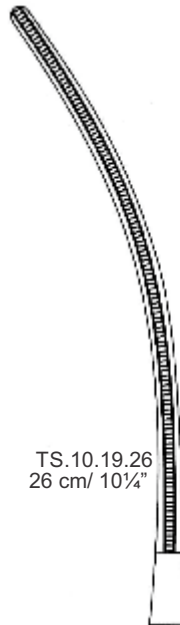

TS.10.19.26  
 26 cm / 10 1/4"

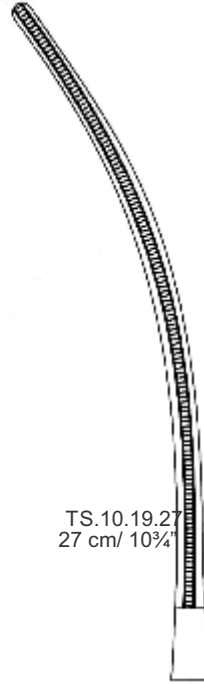

TS.10.19.27  
 27 cm / 10 3/4"

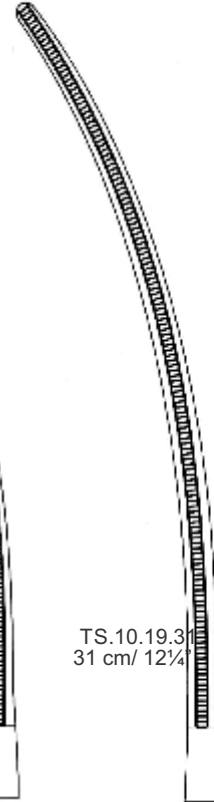

TS.10.19.31  
 31 cm / 12 1/4"

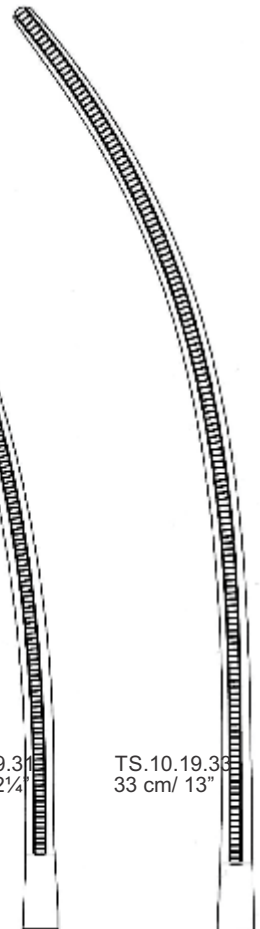

TS.10.19.33  
 33 cm / 13"



DE BAKEY  
 TS.10.20.28  
 28 cm / 11"



Aortic Aneurysm Clamps



DE BAKEY  
 TS.10.20.30  
 30 cm / 11 1/4"

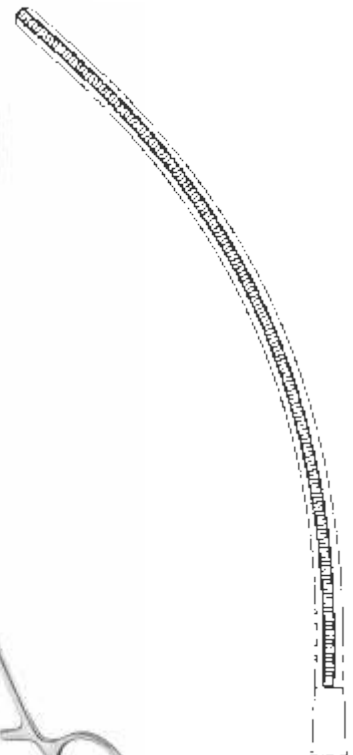

# Cardiovascular Instruments

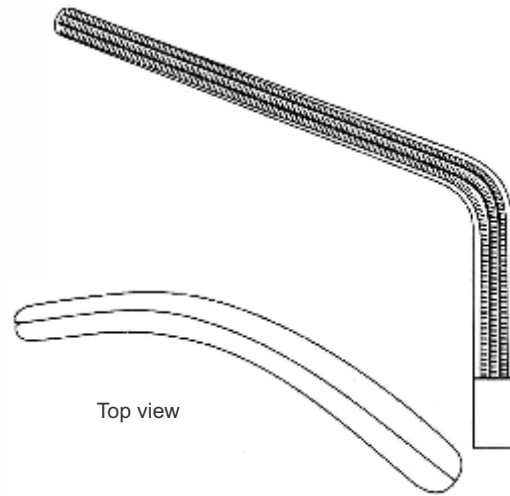

Top view

DE BAKEY  
Aortic Clamps  
TS.10.21.27  
27 cm/ 10 $\frac{3}{4}$ "

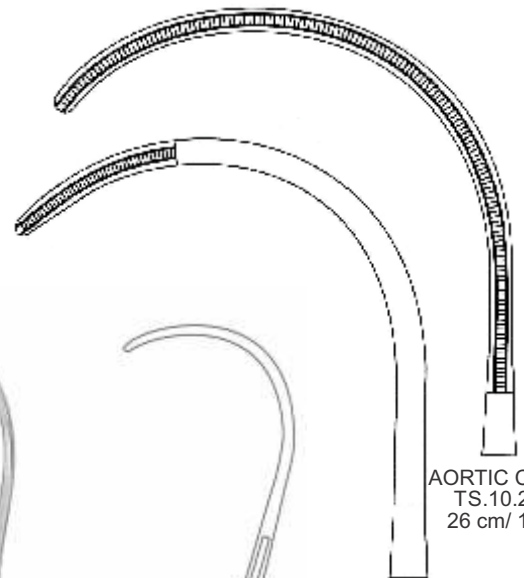

AORTIC CLAMPS  
TS.10.25.26  
26 cm/ 10 $\frac{1}{4}$ "



DE BAKEY  
Ligature Clamps

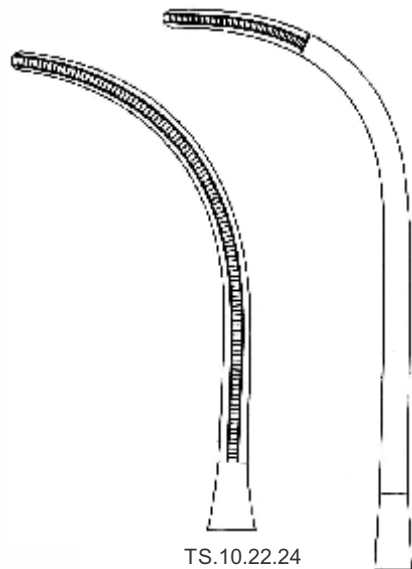

TS.10.22.24  
24 cm/ 9 $\frac{1}{2}$ "

TS.10.23.24  
24 cm/ 9 $\frac{1}{2}$ "



DE BAKEY

LIGATURE CLAMPS  
TS.10.24.25  
25 cm/ 10"

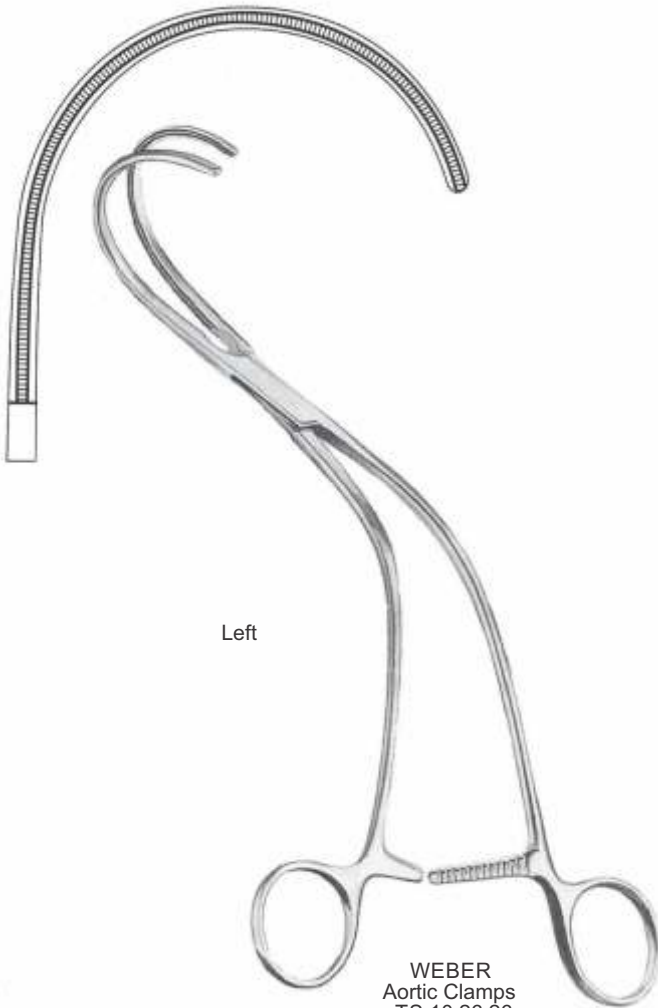

Left

WEBER  
Aortic Clamps  
TS.10.26.26  
26 cm/ 10¼"

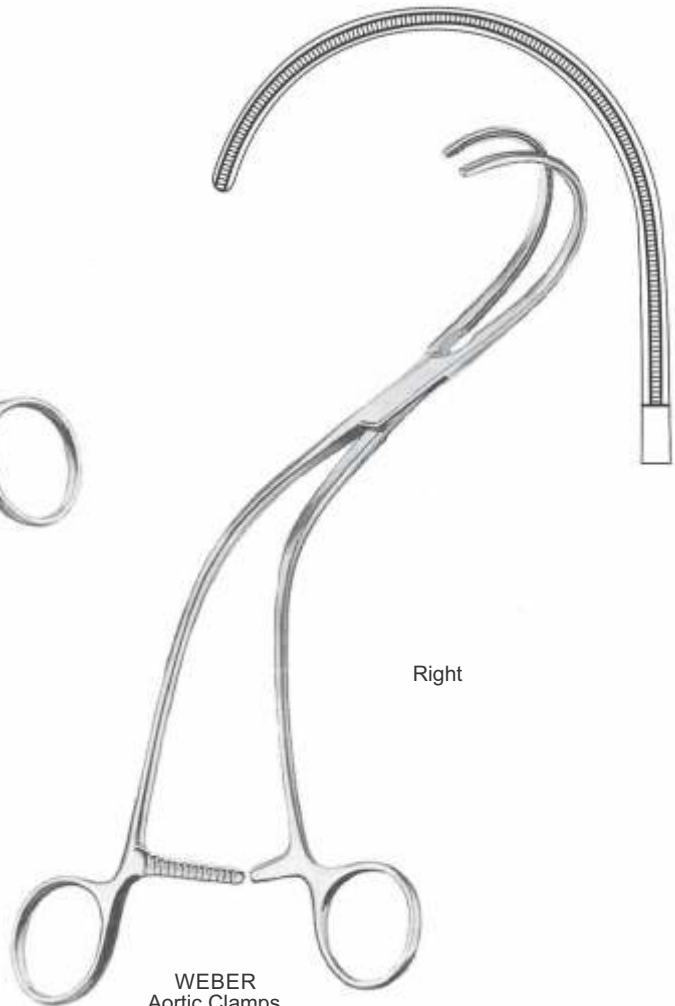

Right

WEBER  
Aortic Clamps  
TS.10.27.26  
26 cm/ 10¼"



# Cardiovascular Instruments

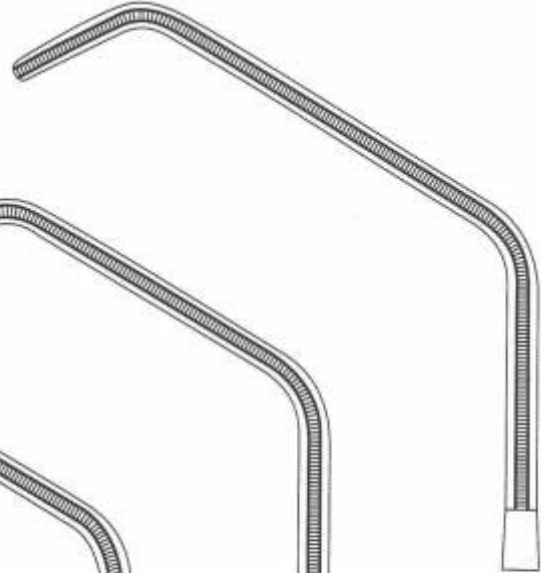

TS.10.28.27  
27.5 cm/ 10¼"

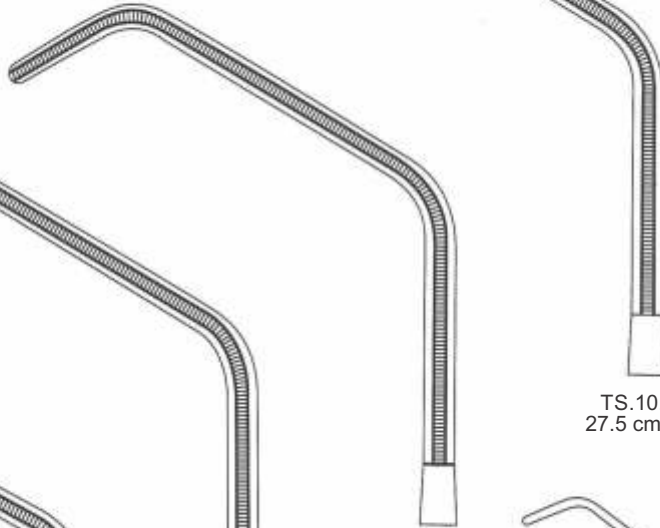

TS.10.28.26  
26.5 cm/ 10½"

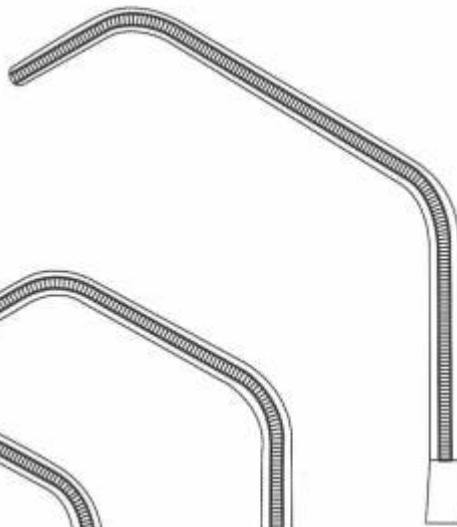

TS.10.28.25  
25 cm/ 10"



TS.10.24.24  
24 cm/ 9½"



TS.10.24.25  
20.5 cm/ 8⅞"



SATINSKY  
Tangential Occlusion  
Clamps



DE BAKEY



HARKEN  
Auricle Clamps

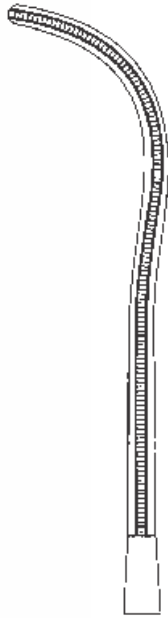

TS.10.29.24  
24 cm/ 9½"

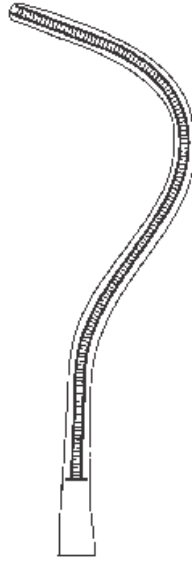

TS.10.30.24  
24 cm/ 9½"

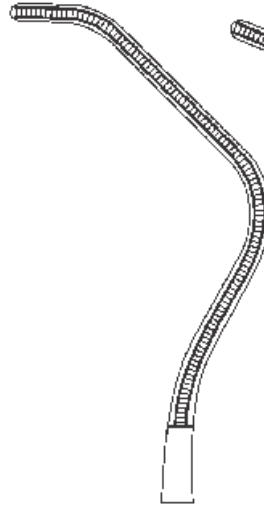

TS.10.31.24  
24 cm/ 9½"

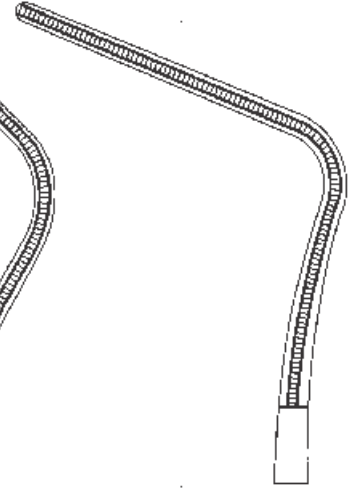

TS.10.32.24  
24 cm/ 9½"



LEES

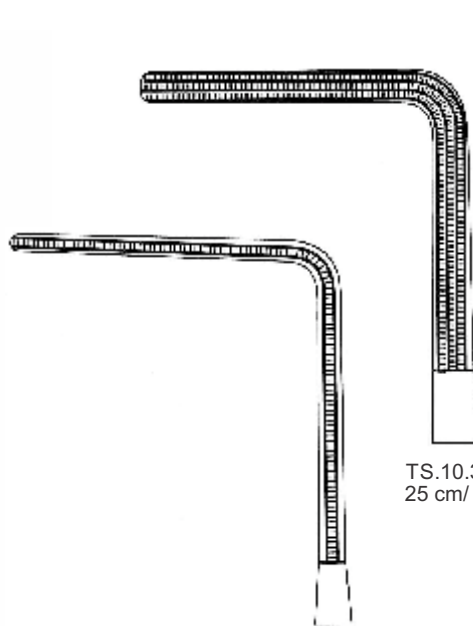

TS.10.33.23  
23 cm/ 9"

TS.10.33.25  
25 cm/ 10"

Bronchus Clamps

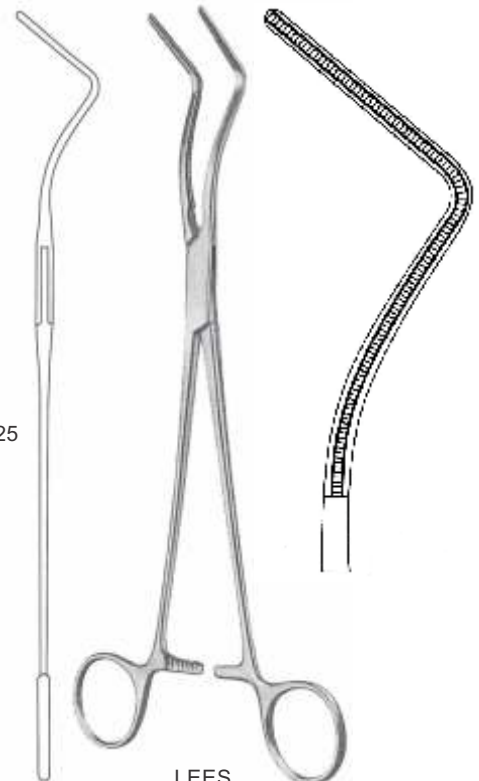

LEES  
TS.10.34.25  
25 cm/ 10"

# Cardiovascular Instruments

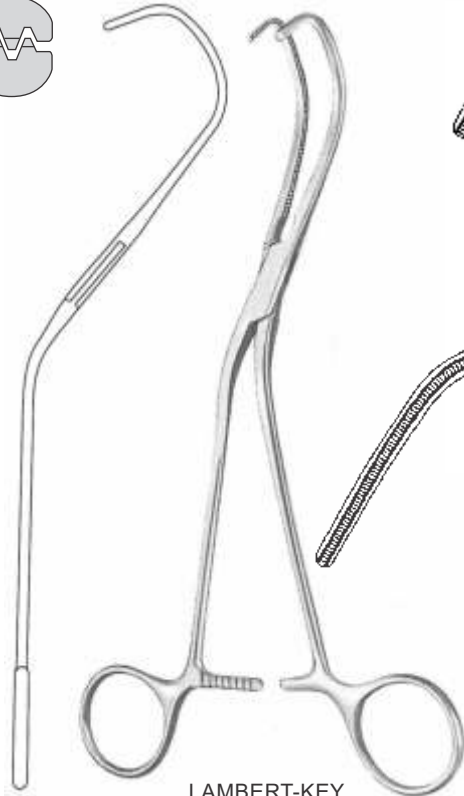

LAMBERT-KEY  
Aortic Clamps

TS.10.35.21  
21 cm/ 8¼"

TS.10.35.22  
21 cm/ 8¼"



DE BAKEY  
TS.10.36.17  
17 cm/ 6¾"  
Anastomosis Clamps



MORRIS-DE BAKEY  
Aortic Clamps

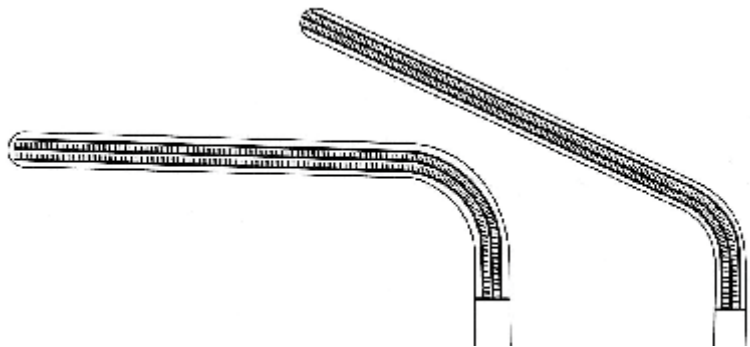

TS.10.37.18  
18 cm/ 7½"

TS.10.37.21  
20 cm/ 8"

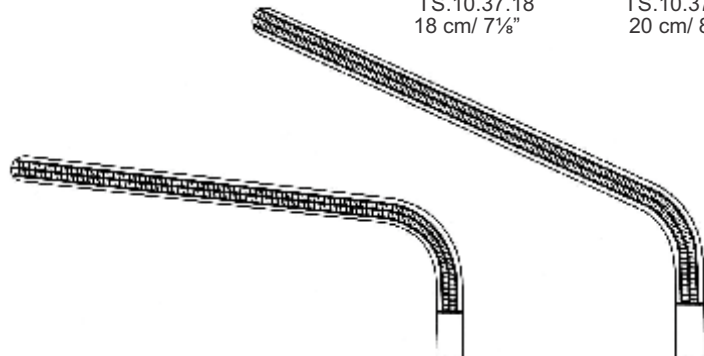

TS.10.37.23  
23 cm/ 9"

TS.10.37.26  
25 cm/ 10"

# Cardiovascular Instruments



DE BAKEY-BAHNSON  
 Aneurysm Clamps  
 for Iliac Artery

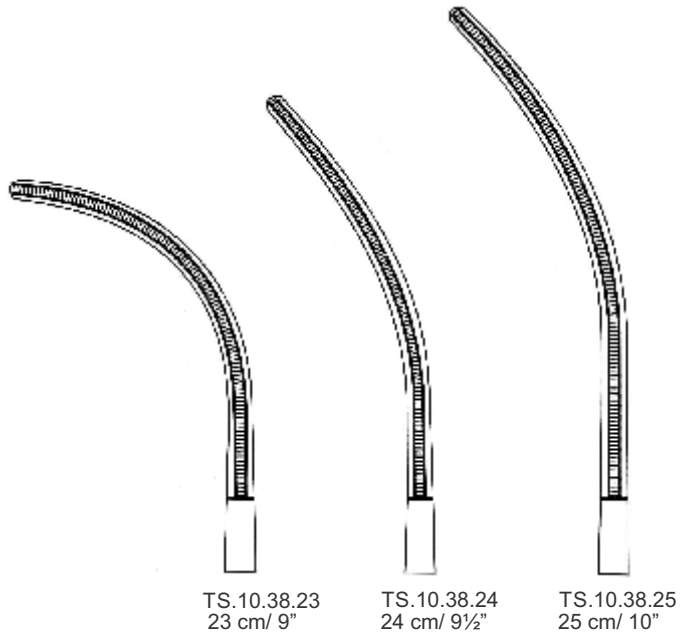

DE BAKEY  
 Coarctation Clamps

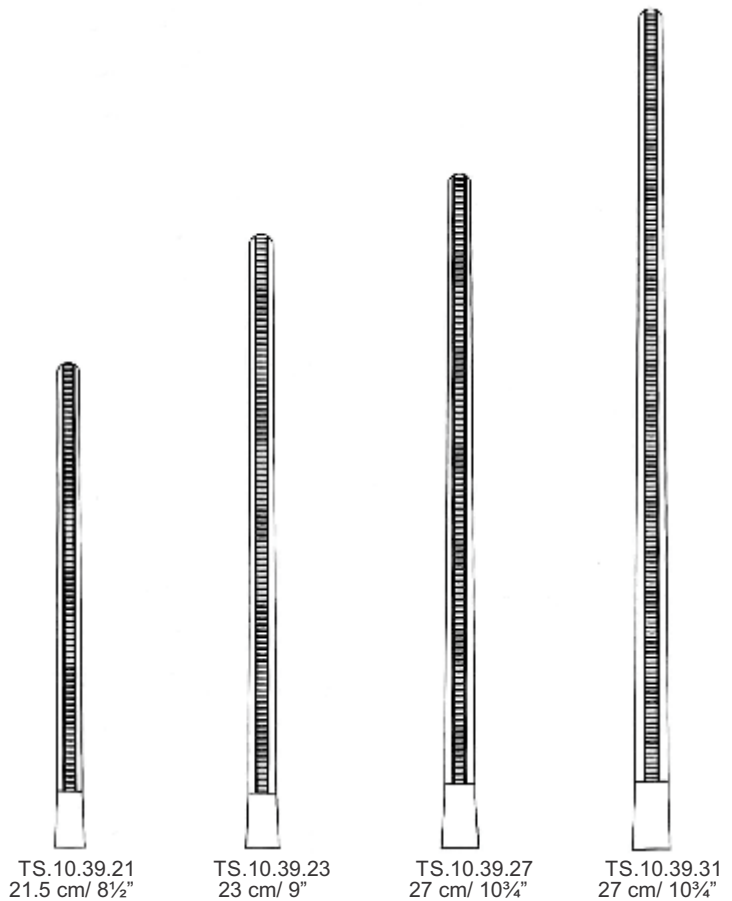

# Cardiovascular Instruments



DE BAKEY  
Coarctation Clamps

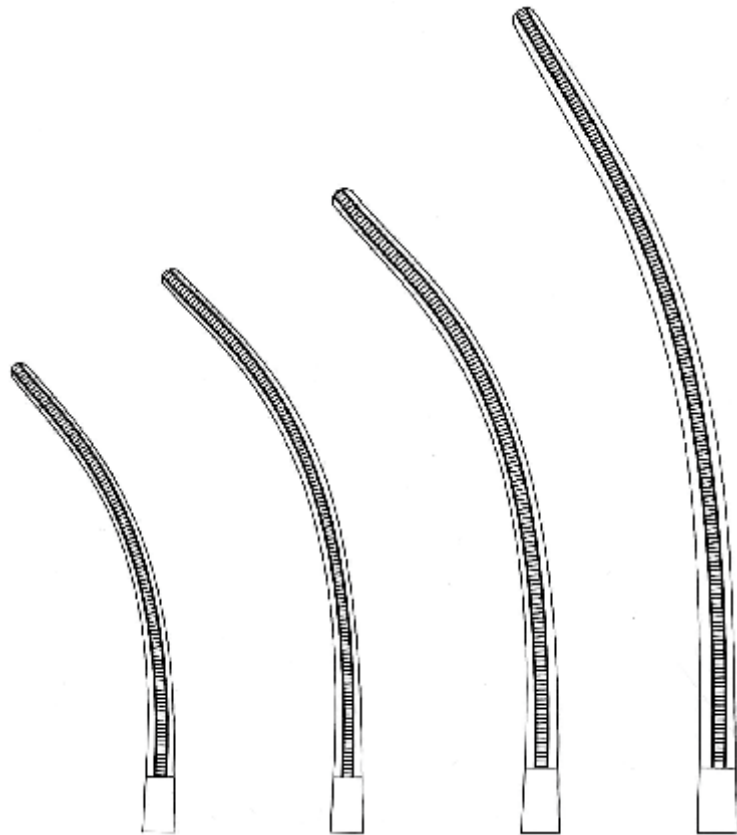

TS.10.40.21  
21.5 cm / 8½"

TS.10.40.23  
23 cm / 9"

TS.10.40.27  
27 cm / 10¾"

TS.10.40.31  
31 cm / 12¼"



DE BAKEY  
Multi-purpose Clamps

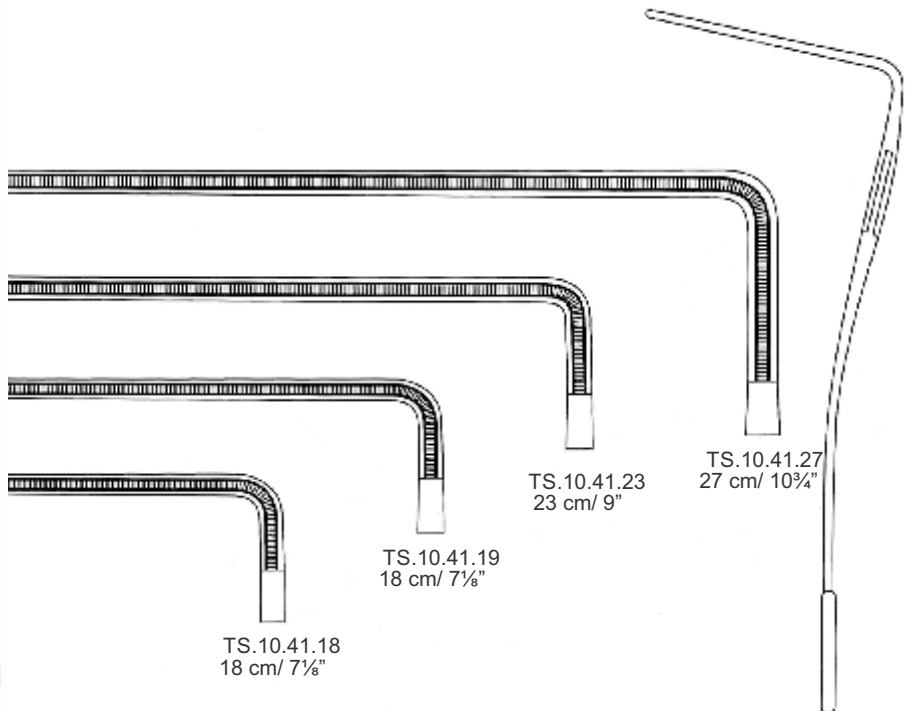

TS.10.41.18  
18 cm / 7½"

TS.10.41.19  
18 cm / 7½"

TS.10.41.23  
23 cm / 9"

TS.10.41.27  
27 cm / 10¾"



DE BAKEY  
Multi-purpose Clamps

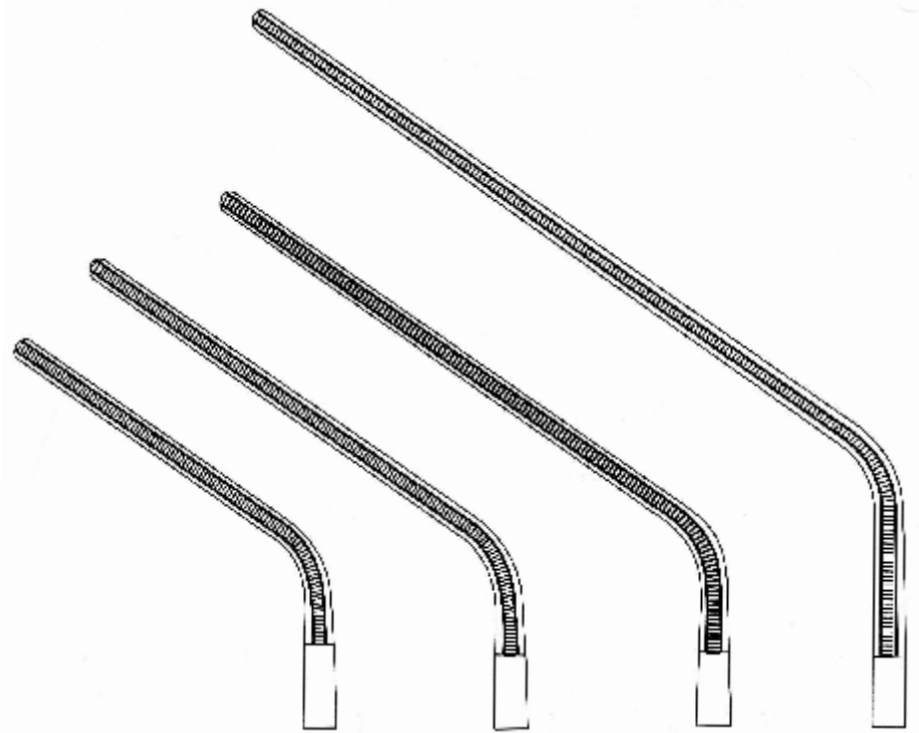

TS.10.42.20  
20 cm / 8"

TS.10.42.21  
21 cm / 8¼"

TS.10.42.25  
25 cm / 10"

TS.10.42.29  
29 cm / 11½"

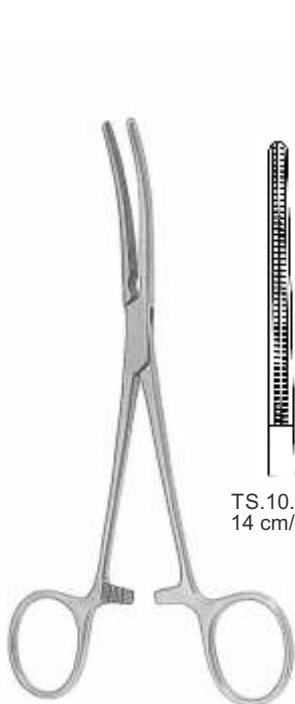

DE BAKEY-PEAN

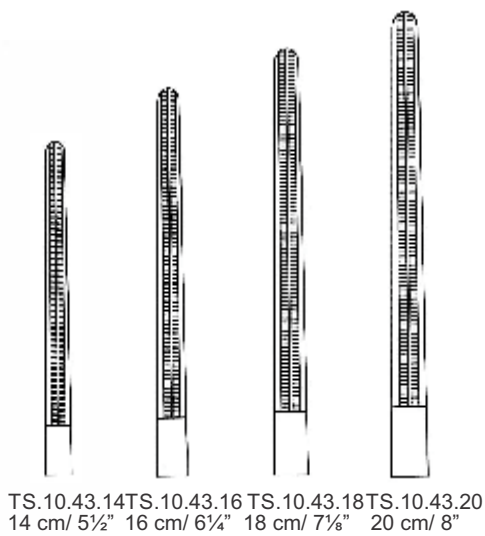

TS.10.43.14 TS.10.43.16 TS.10.43.18 TS.10.43.20  
14 cm / 5½" 16 cm / 6¼" 18 cm / 7⅛" 20 cm / 8"

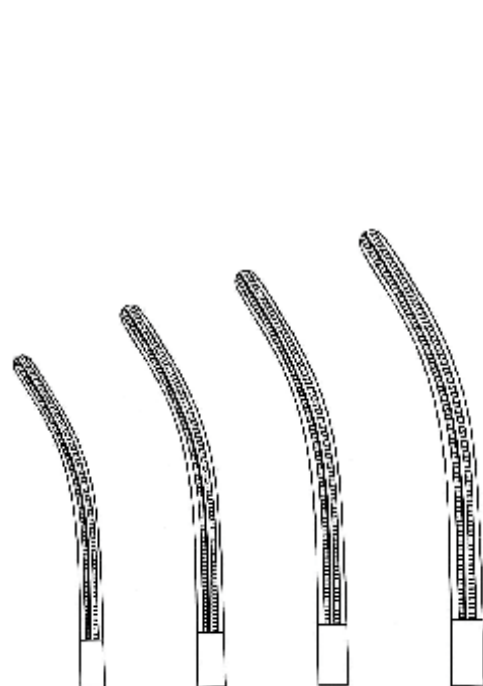

TS.10.44.14 TS.10.44.16 TS.10.44.18 TS.10.44.20  
14 cm / 5½" 16 cm / 6¼" 18 cm / 7⅛" 20 cm / 8"

# Cardiovascular Instruments



DE BAKEY  
TS.10.46.17  
17 cm/ 6¾"



DE BAKEY  
TS.10.47.16  
16 cm/ 6¼"

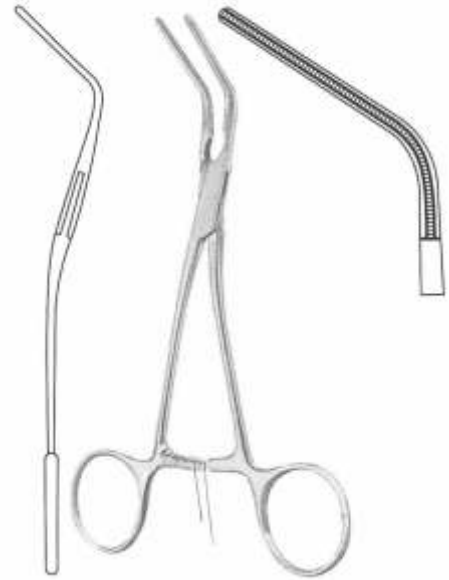

DE BAKEY  
TS.10.48.15  
15 cm/ 6"

## Multi-purpose Clamps

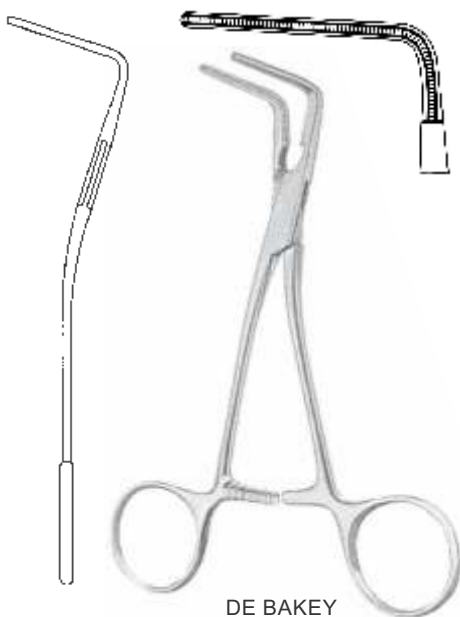

DE BAKEY  
TS.10.50.15  
15 cm/ 6"



DE BAKEY  
TS.10.51.17  
17 cm/ 6¾"

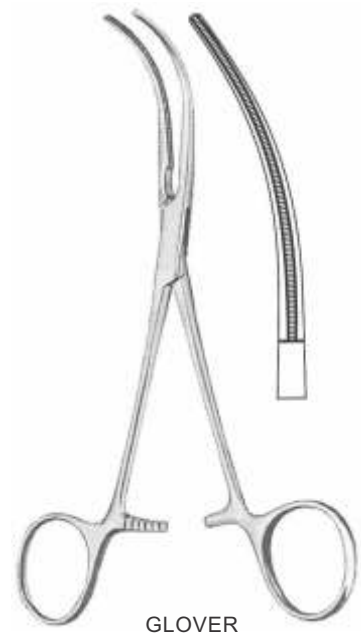

GLOVER  
TS.10.52.17  
17 cm/ 6¾"

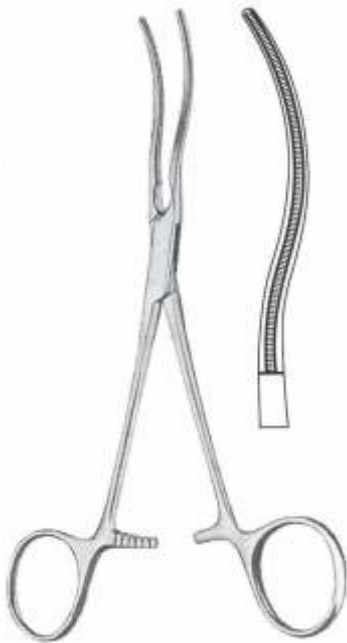

COARCTATION CLAMPS  
TS.10.53.17  
17 cm/ 6¾"



LIGATURE CLAMPS

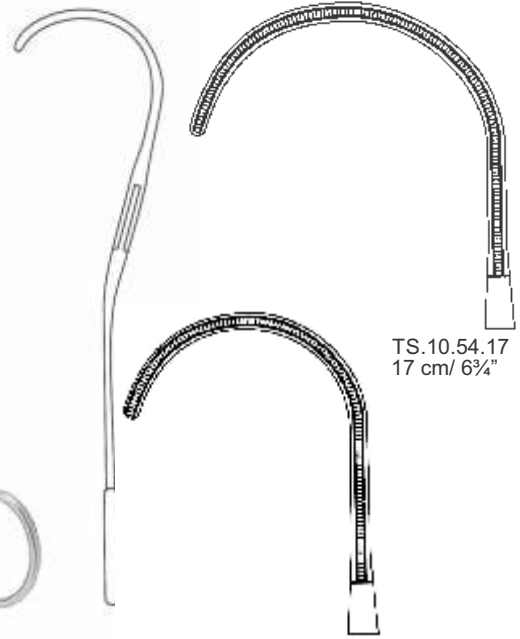

TS.10.54.17  
17 cm/ 6¾"

TS.10.54.16  
16 cm/ 6¼"

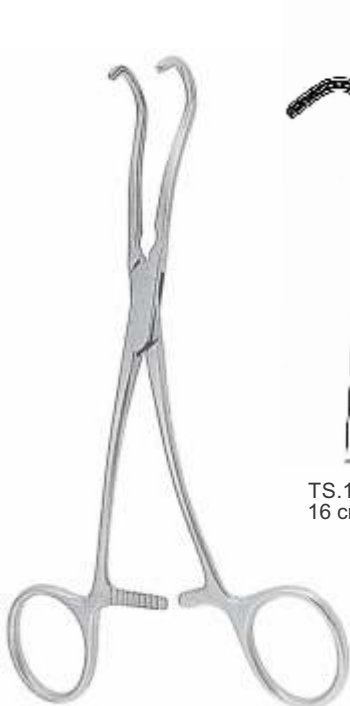

DERRA  
Anastomosis Clamps



TS.10.55.16  
16 cm/ 6¼"



TS.10.55.17  
17 cm/ 6¾"



TS.10.55.18  
18 cm/ 7⅞"



BECK  
Tangential Occlusion Clamps  
TS.10.56.17  
17 cm/ 6¾"



# Cardiovascular Instruments

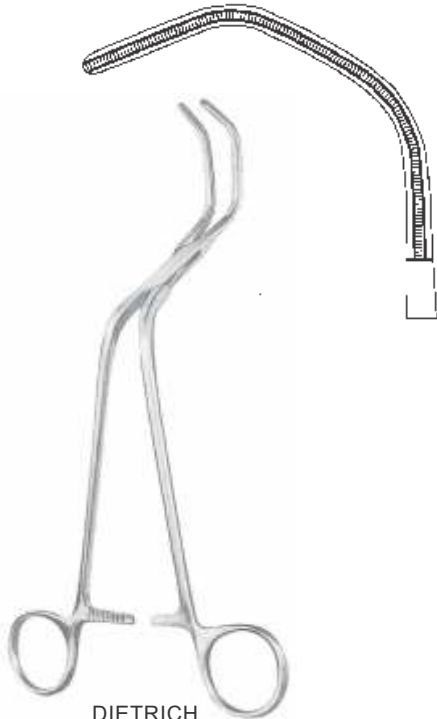

DIETRICH  
Aortic Clamps  
TS.10.56.21  
21 cm/ 8¼"



OCHSNER  
Aortic Clamps  
TS.10.56.24  
23.5 cm/ 9¼"

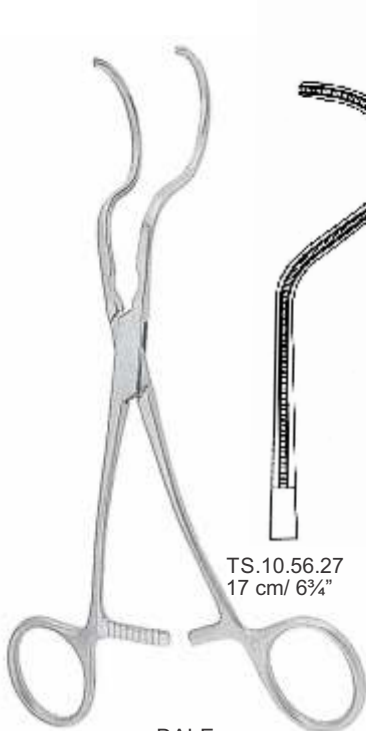

DALE  
Peripheral Vascular Clamps

TS.10.56.27  
17 cm/ 6¾"

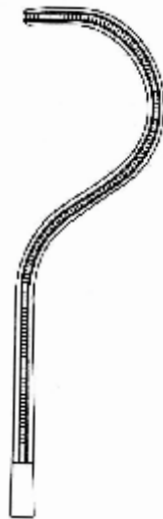

TS.10.56.58  
18 cm/ 7⅞"

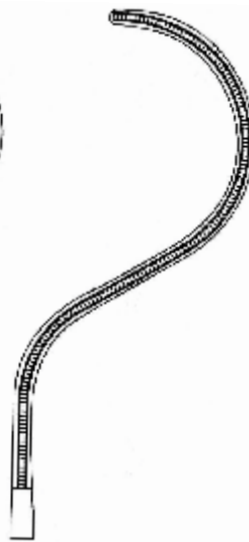

TS.10.56.59  
18.5 cm/ 7¼"

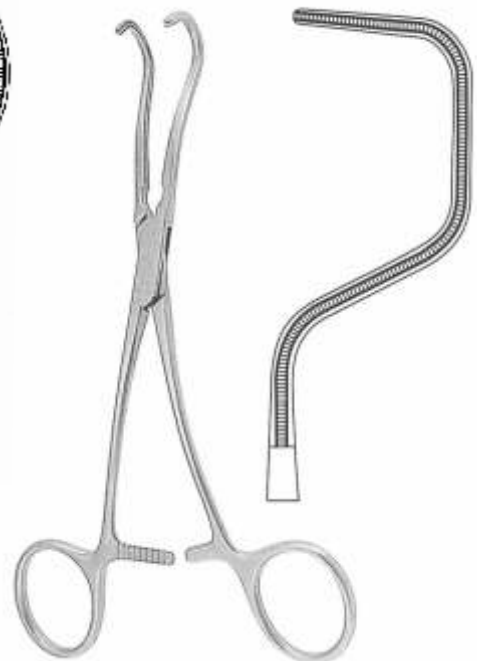

DALE  
TS.10.56.78  
18.5 cm/ 7¼"



PEDIATRIC  
 SURGERY



DE BAKEY  
 TS.10.57.10  
 10 cm/ 4"



DE BAKEY  
 TS.10.57.11  
 11 cm/ 4 1/4"



DE BAKEY  
 TS.10.59.12  
 12 cm/ 4 3/4"

Bulldog clamps

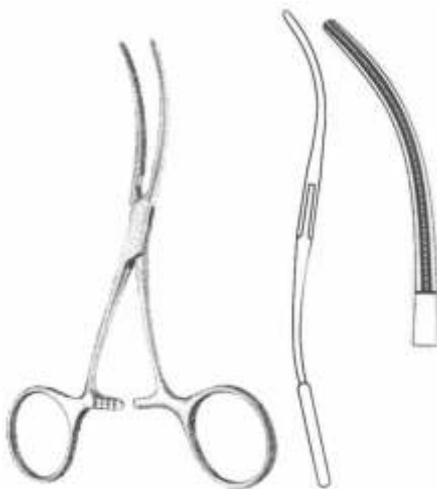

DE BAKEY  
 TS.10.60.12  
 12 cm/ 4 3/4"



DE BAKEY  
 TS.10.61.13  
 13 cm/ 5 1/8"

# Cardiovascular Instruments

3

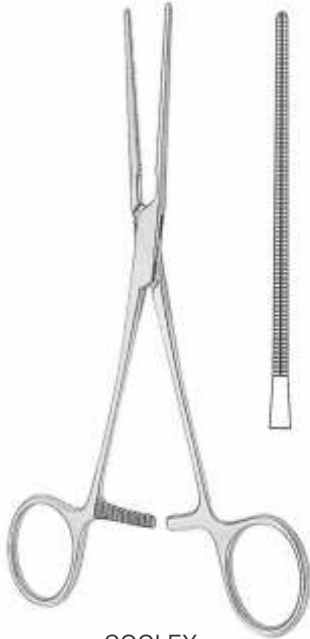

COOLEY  
Coarctation Forceps  
TS.11.65.17  
17 cm/ 6¾"

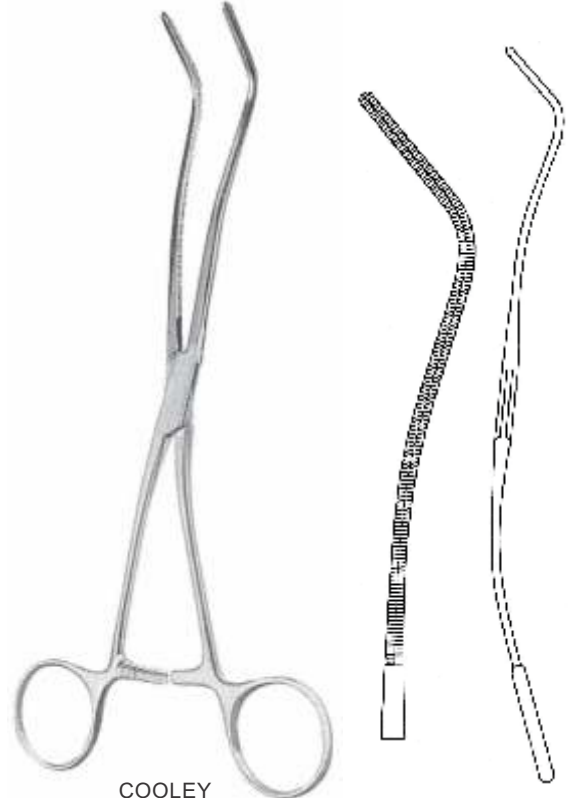

COOLEY  
Renal Artery Clamp also used  
for subclavian and carotid artery  
TS.11.66.20  
20 cm/ 8"

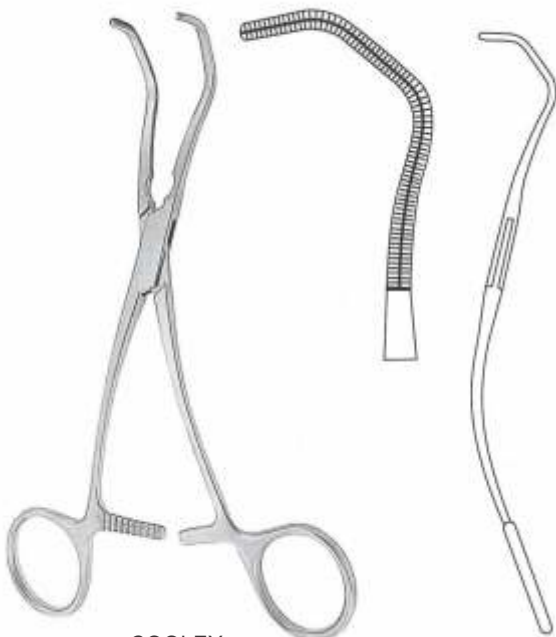

COOLEY  
TS.11.67.16  
16 cm/ 6¼"

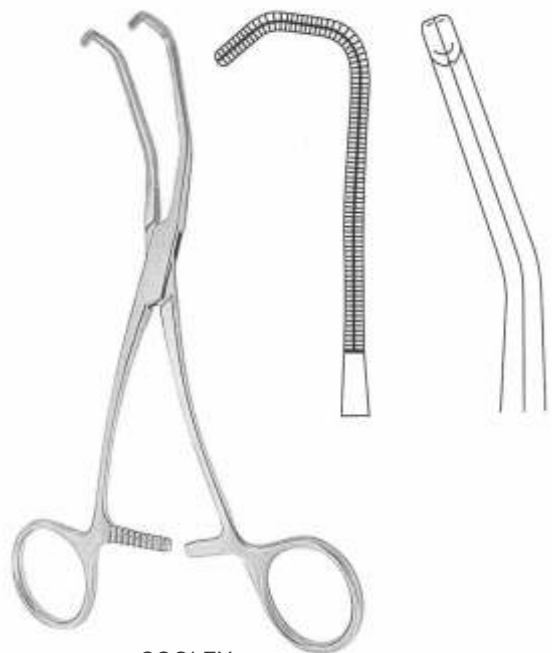

COOLEY  
Anastomosis Clamps  
TS.11.67.17  
17 cm/ 6¾"

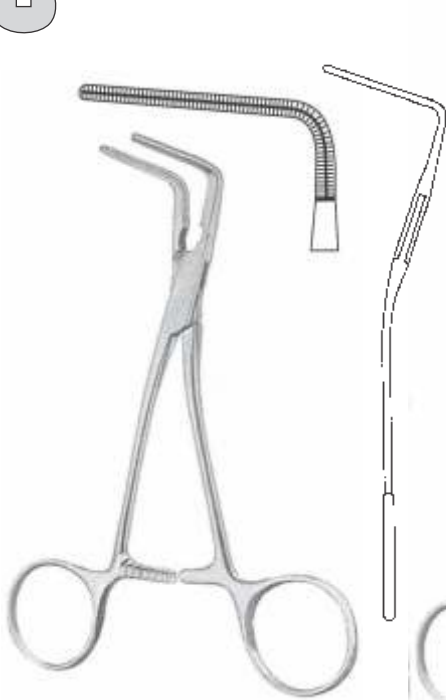

COOLEY  
 TS.11.68.15  
 15 cm/ 6"

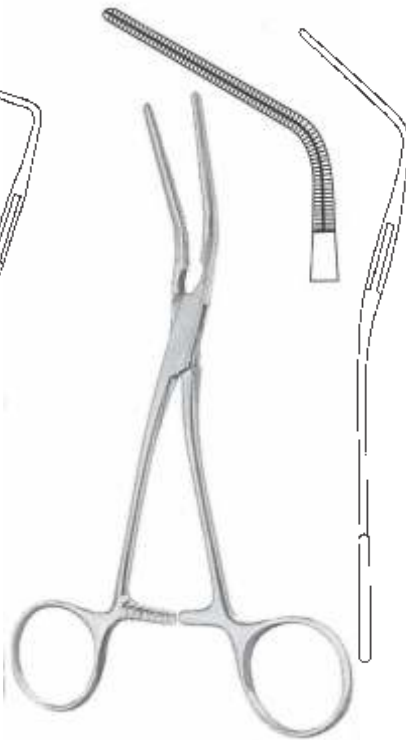

COOLEY  
 TS.11.69.16  
 15.5 cm/ 6 1/8"

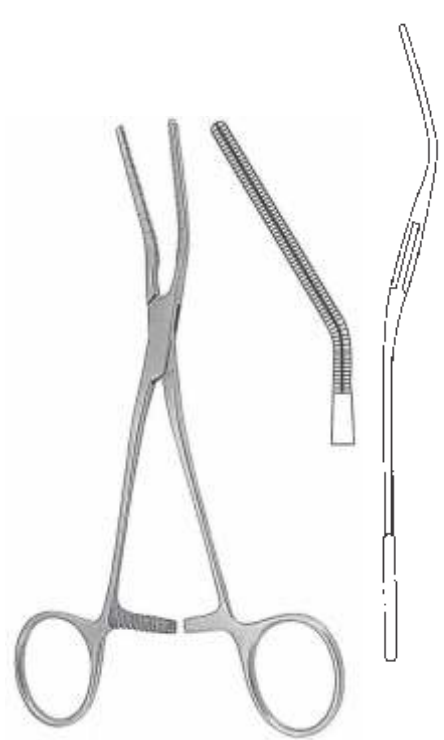

COOLEY  
 TS.11.70.17  
 17 cm/ 6 3/4"

Multi-purpose Clamps



COOLEY  
 Iliac Clamps  
 TS.11.71.17  
 17 cm/ 6 3/4"



COOLEY  
 TS.11.72.17  
 17 cm/ 6 3/4"



COOLEY  
 Coarctation Clamps  
 TS.11.73.17  
 17 cm/ 6 3/4"

# Cardiovascular Instruments

3



COOLE-DERRA  
Anastomosis Clamps



TS.11.74.16  
16 cm/ 6¼"



TS.11.74.17  
17 cm/ 6¾"



TS.11.74.18  
18 cm/ 7½"

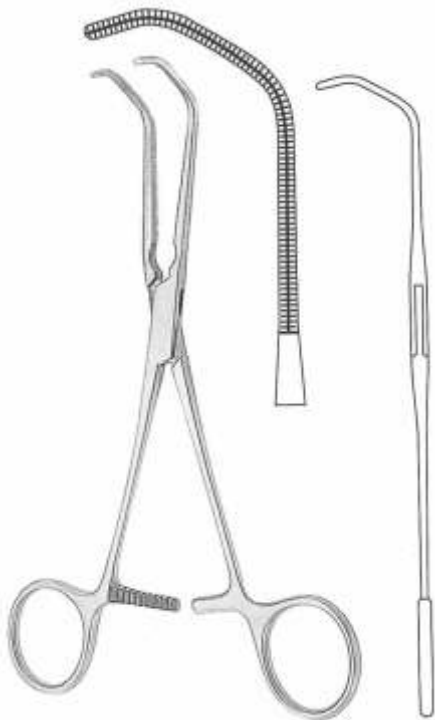

BECK  
TS.11.75.17  
17 cm/ 6¾"

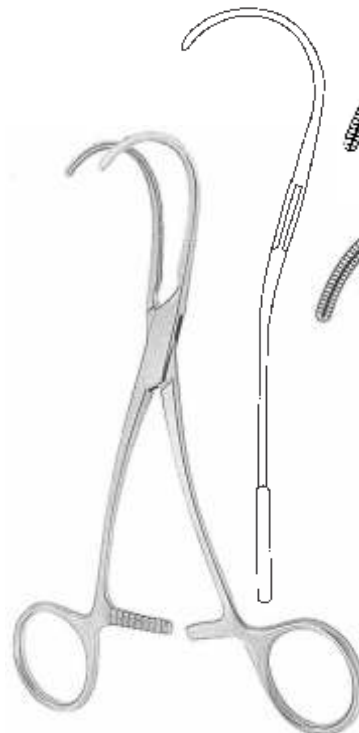

COOLEY  
Ligature Clamps

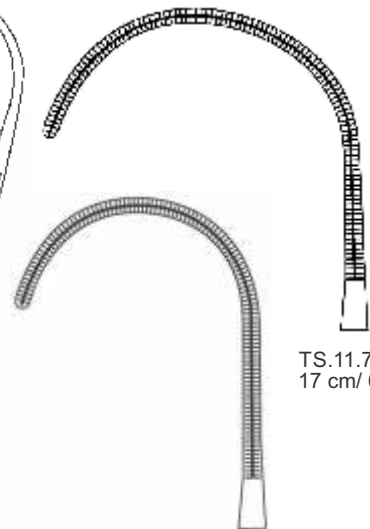

TS.11.76.17  
17 cm/ 6¾"

TS.11.76.16  
16 cm/ 6¼"

3



TS.11.77.14  
14 cm/ 5½"



TS.11.77.15  
14 cm/ 5½"

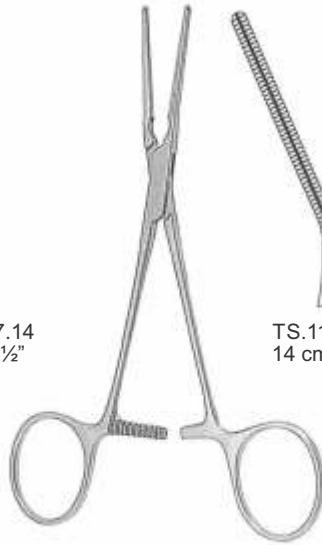

COOLEY



COOLEY  
TS.11.77.34  
14 cm/ 5½"



COOLEY  
TS.11.77.44  
14 cm/ 5½"

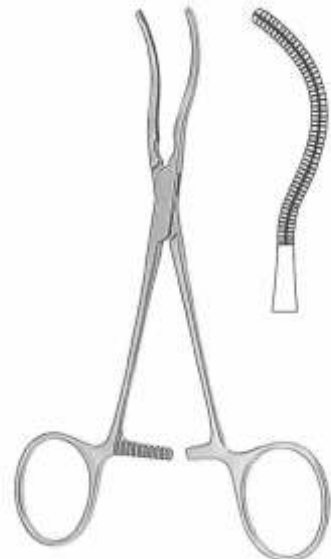

COOLEY  
TS.11.77.54  
14 cm/ 5½"

# Cardiovascular Instruments



TS.11.77.61  
13 cm/ 5 $\frac{1}{8}$ "



TS.11.77.62  
13 cm/ 5 $\frac{1}{8}$ "



TS.11.77.63  
11 cm/ 4 $\frac{1}{4}$ "



CASTANEDA  
Fine Neonatal Vascular Clamps

Graduated



TS.11.77.64  
12 cm/ 4 $\frac{3}{4}$ "



TS.11.77.65  
12 cm/ 4 $\frac{3}{4}$ "

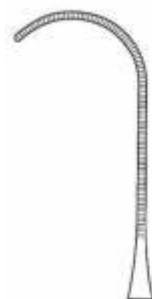

TS.11.77.66  
12 cm/ 4 $\frac{3}{4}$ "



TS.11.77.67  
12 cm/ 4 $\frac{3}{4}$ "



## Vena-Cava Forceps



SATINSKY

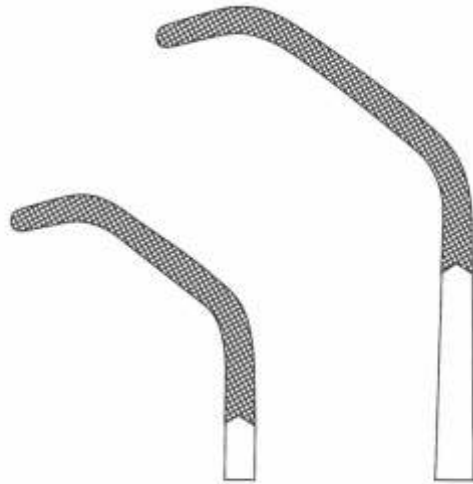

TS.11.77.70  
20 cm/ 8"

TS.11.77.72  
27 cm/ 10¾"



BABY SATINSKY  
TS.11.77.75  
15 cm/ 6"



HARKEN



TS.11.77.84  
24 cm/ 9½"



TS.11.77.85  
24 cm/ 9½"

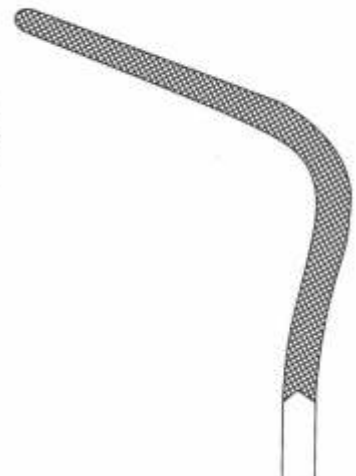

TS.11.77.94  
24 cm/ 9½"



# Cardiovascular Instruments

## Vascular dilators



**COOLEY**  
13 cm/ 5 1/8"

- TS.11.77.105 Ø 0.5 mm
- TS.11.77.110 Ø 1.0 mm
- TS.11.77.115 Ø 1.5 mm
- TS.11.77.120 Ø 2.0 mm
- TS.11.77.125 Ø 2.5 mm
- TS.11.77.130 Ø 3.0 mm
- TS.11.77.140 Ø 4.0 mm
- TS.11.77.150 Ø 5.0 mm



**DE BAKEY**  
19 cm/ 7 1/2"

TS.11.78.00  
Set of 12 pieces from  
TS.11.78.05 to TS.11.78.90

- TS.11.78.05 Ø 0.5 mm
- TS.11.78.10 Ø 1.0 mm
- TS.11.78.15 Ø 1.5 mm
- TS.11.78.20 Ø 2.0 mm
- TS.11.78.25 Ø 2.5 mm
- TS.11.78.30 Ø 3.0 mm
- TS.11.78.35 Ø 3.5 mm
- TS.11.78.40 Ø 4.0 mm
- TS.11.78.45 Ø 4.5 mm
- TS.11.78.50 Ø 5.0 mm
- TS.11.78.70 Ø 7.0 mm
- TS.11.78.90 Ø 9.0 mm

## Varicose vein strippers



**GARRETT**  
14 cm/ 5 1/2"

TS.11.79.190  
Set of 9 pieces from  
TS.11.79.110 to TS.11.79.150

- TS.11.79.110 Ø 1.0 mm
- TS.11.79.115 Ø 1.5 mm
- TS.11.79.120 Ø 2.0 mm
- TS.11.79.125 Ø 2.5 mm
- TS.11.79.130 Ø 3.0 mm
- TS.11.79.135 Ø 3.5 mm
- TS.11.79.140 Ø 4.0 mm
- TS.11.79.145 Ø 4.5 mm
- TS.11.79.150 Ø 5.0 mm



**GARRETT**  
21 cm/ 8 1/4"

TS.11.79.290  
Set of 9 pieces from  
TS.11.79.210 to TS.11.79.250

- TS.11.79.210 Ø 1.0 mm
- TS.11.79.215 Ø 1.5 mm
- TS.11.79.220 Ø 2.0 mm
- TS.11.79.225 Ø 2.5 mm
- TS.11.79.230 Ø 3.0 mm
- TS.11.79.235 Ø 3.5 mm
- TS.11.79.240 Ø 4.0 mm
- TS.11.79.245 Ø 4.5 mm
- TS.11.79.250 Ø 5.0 mm

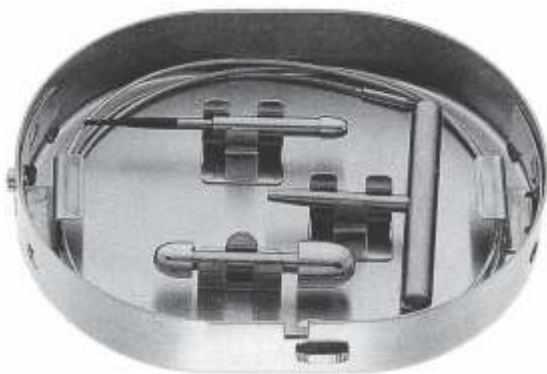

**NABATOFF**  
Complete  
PB-42.00



TS.11.47.26  
Ø 6 mm



TS.11.48.29  
Ø 9 mm



TS.11.48.32  
Ø 12 mm



TS.11.50.35  
Ø 15 mm

## METAL OLIVES

**COOLEY**  
13 cm/ 5 1/8"

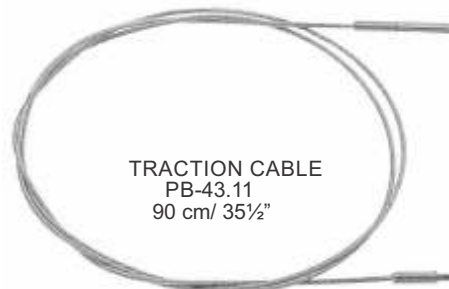

**TRACTION CABLE**  
PB-43.11  
90 cm/ 35 1/2"



**HANDLE**  
PB-44.12



**PLASTIC TIP**  
PB-45.16

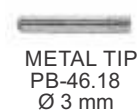

**METAL TIP**  
PB-46.18  
Ø 3 mm

# Cardiovascular Instruments





Eye Instruments

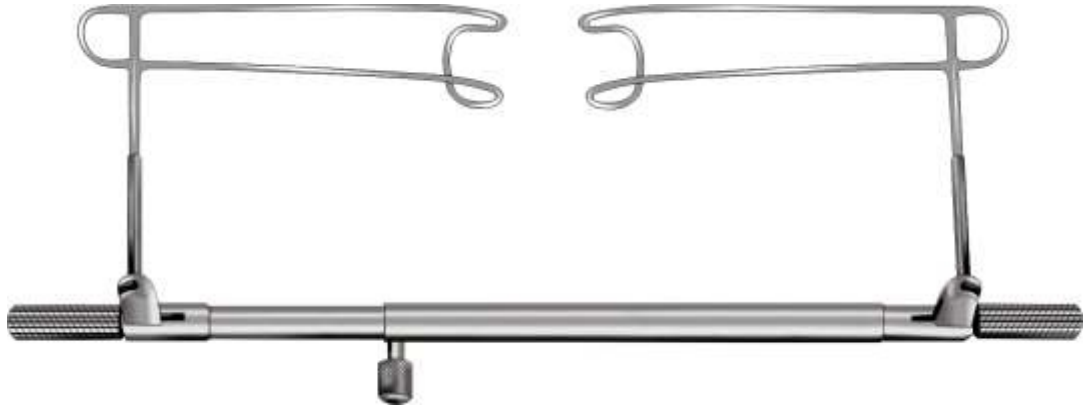

**SCHOTT EYE SPECULUM**  
 Fenestrated, individually adjustable blades for  
 controlled lid elevation  
 TS.11.100.01 Adult Size  
 TS.11.100.02 Child Size

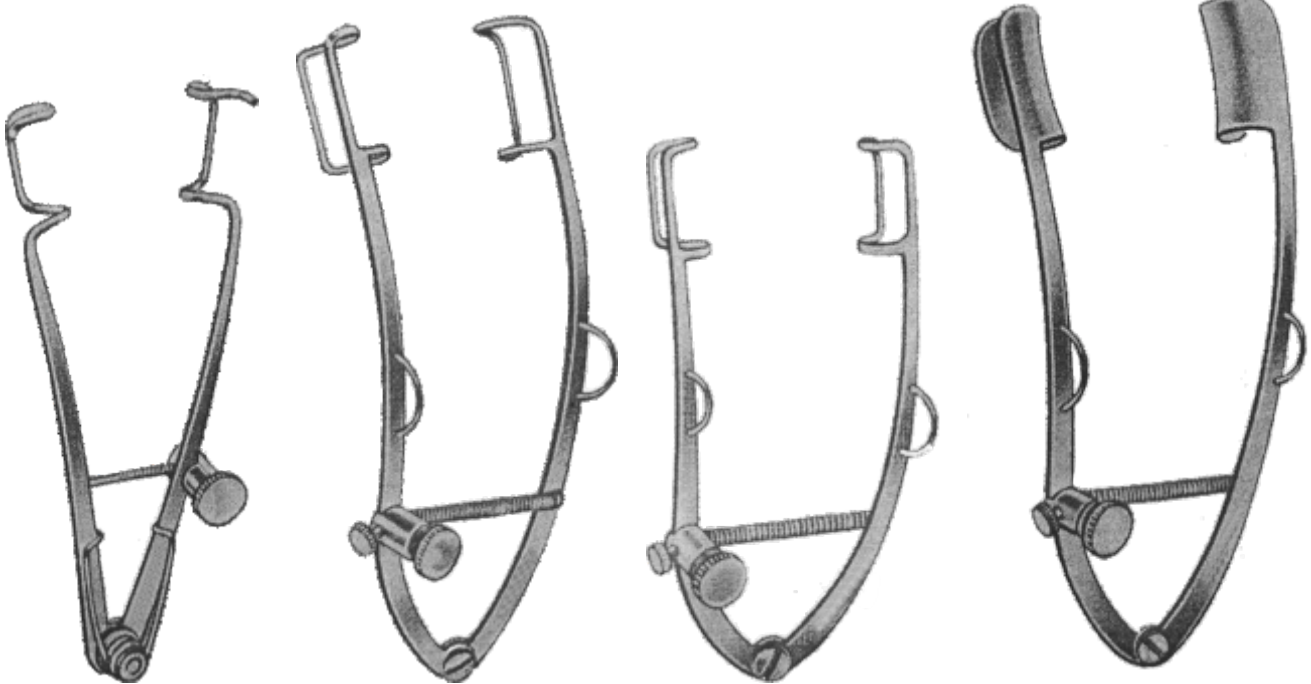

**WEISS EYE SPECULUM**  
 With open blades  
 TS.11.104.06

**WEISS EYE SPECULA LARGE**  
 With fenestrated blades  
 TS.11.105.07

**WEISS EYE SPECULA SMALL**  
 With fenestrated blades  
 TS.11.106.06

**WEISS EYE SPECULA LARGE**  
 With solid blades  
 TS.11.107.09

# Eye Instruments

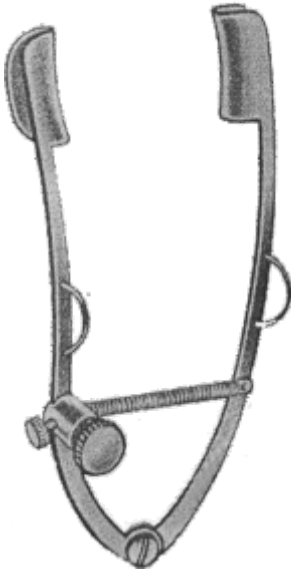

**WEISS EYE SPECULA SMALL**  
With solid blades  
TS.11.108.08

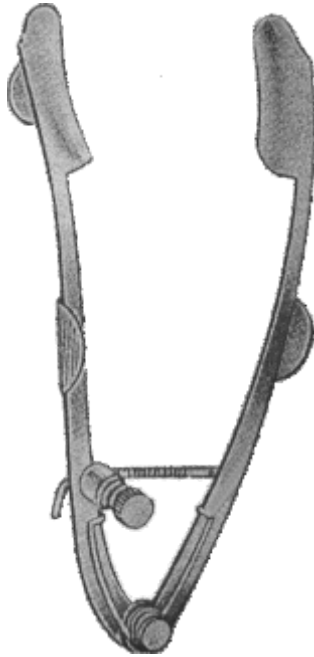

**LESTER-BURCH EYE SPECULA**  
With locking screw, solid blades  
TS.11.109.14

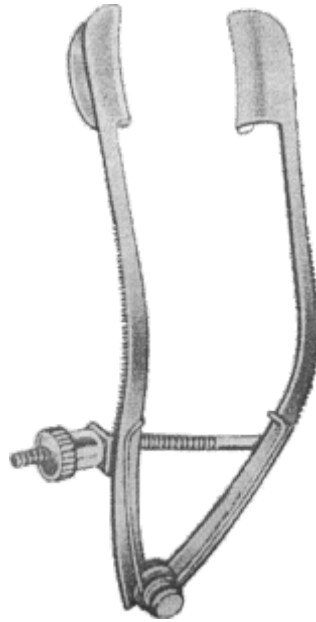

**LANCASTER EYE SPECULA**  
With locking screw, solid blades  
TS.11.110.06

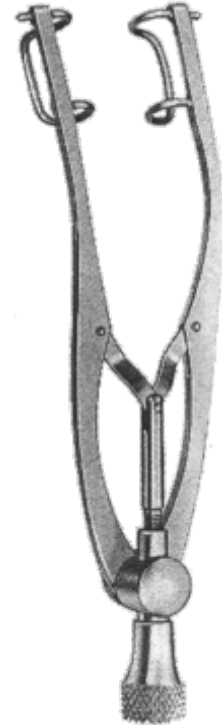

**CASTROVIEJO EYE SPECULA**  
TS.11.111.14 Small (14 mm blades)  
TS.11.112.16 Medium (16 mm blades)  
TS.11.113.18 Large (18 mm blades)

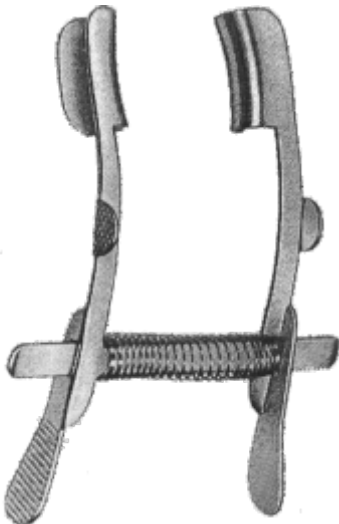

**MELLINGER-BEARD EYE SPECULA**  
With solid blades  
TS.11.114.01 Child size  
TS.11.114.02 Adult size

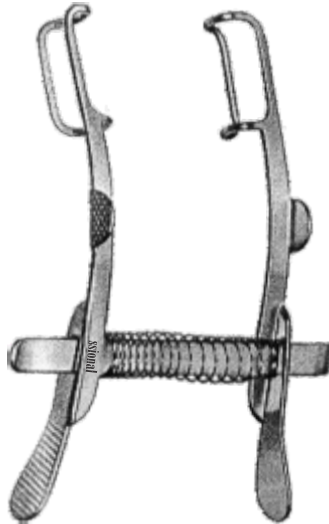

**MELLINGER EYE SPECULUM**  
With fenestrated blades  
TS.11.115.01 Child size  
TS.11.116.02 Adult size



**COOK EYE SPECULUM**  
Infant size  
TS.11.117.01

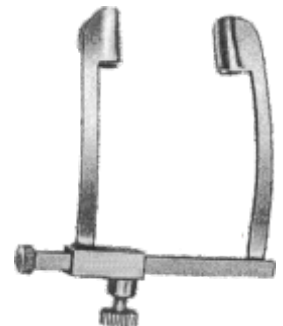

**COOK EYE SPECULUM**  
Child size  
TS.11.118.02

# Eye Instruments



**COOK EYE SPECULUM**  
Adolescent size  
TS.11.119.03

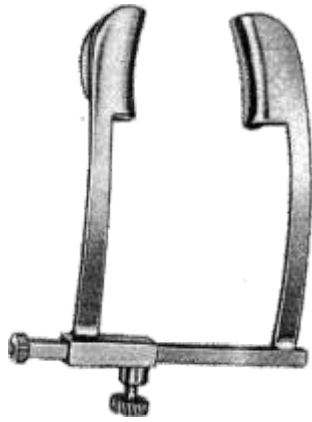

**COOK EYE SPECULUM**  
Adult size  
TS.11.120.04

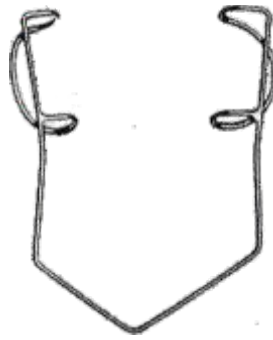

**BARRAQUER EYE SPECULUM**  
Fenestrated round blades  
TS.11.121.14 Adult size (14 mm wide)  
TS.11.122.10 Child size (10 mm wide)  
TS.11.123.05 Infant size (5 mm wide)  
TS.11.124.03 premature (3 mm wide)

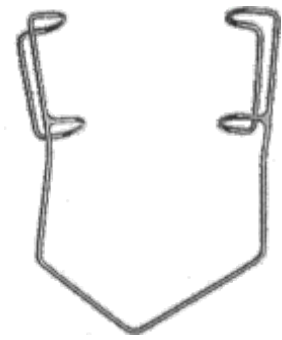

**BARRAQUER EYE SPECULUM**  
Fenestrated blades  
TS.11.122.15 Adult size (15 mm wide)  
TS.11.122.10 Child size (10 mm wide)  
TS.11.122.05 Infant size (5 mm wide)  
TS.11.122.03 Premature (3 mm wide)



**BARRAQUER EYE SPECULUM**  
Solid blades  
TS.11.123.15 Adult size (15 mm wide)  
TS.11.124.10 Child size (10 mm wide)

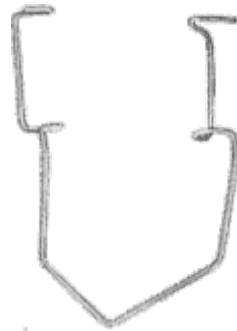

**KRATZ - BARRAQUER EYE SPECULUM**  
Open blades  
TS.11.125.01 Adult size  
TS.11.126.02 Child size  
TS.11.127.03 Heavy 1 mm model



**JAFFE LID RETRACTOR**  
With fenestrated blade, may be clamped to surgical drape with suture or elastic band  
TS.11.128.14 Adult size (14 mm wide)  
TS.11.129.10 Child size (10 mm wide)



**TENNANT LID RETRACTOR**  
With solid blade, may be clamped to surgical drape with suture or elastic band  
TS.11.130.14 Adult size (14 mm wide)



**CLAYMAN LID RETRACTOR (set of two)**  
Mobile, fenestrated blade may be clamped to surgical drape with suture or elastic band  
TS.11.131.14 Adult size (14 mm wide)



**SAUER LID SPECULUM**  
Self-retaining, with solid blades  
TS.11.132.10 Child size (10 mm wide)  
TS.11.133.06 Infant size (6 mm wide)  
TS.11.134.04 Premature (4 mm wide)

# Eye Instruments



**MURDOCH EYE SPECULUM**  
With large fenestrated blades  
TS.11.135.01 Right model  
TS.11.136.02 Left model



**CLARK EYE SPECULUM**  
With adjustment screw and open blades  
TS.11.137.08

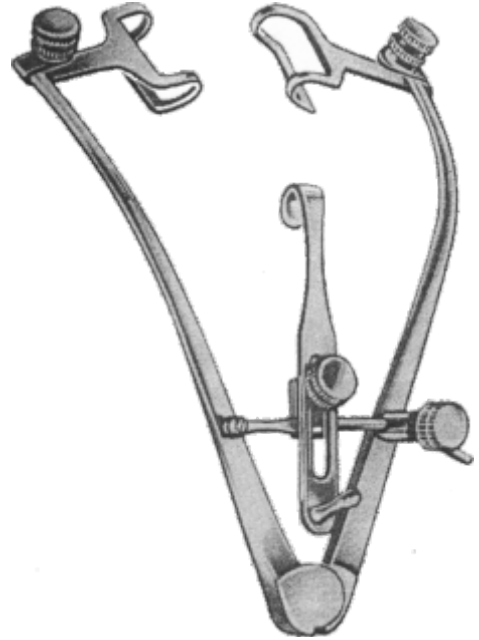

**MAUMMEE - PARK EYE SPECULUM**  
Mobile fenestrated blades with locking screw and hooked enter blade  
TS.11.138.01

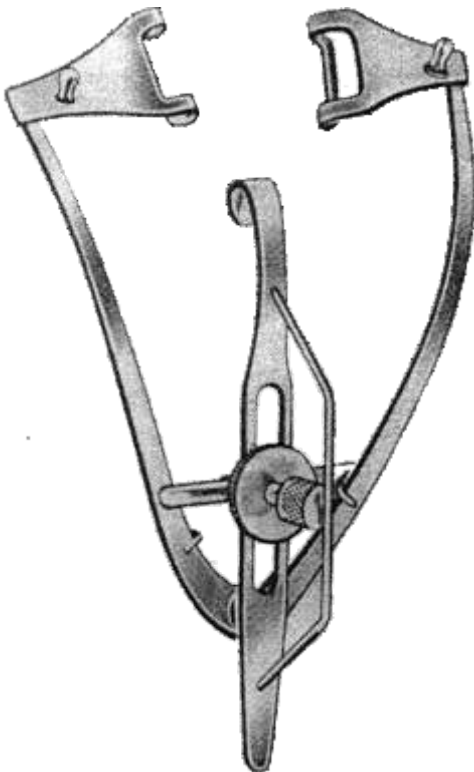

**PARK - GUYTON EYE SPECULUM**  
Mobile fenestrated blades with vertical suture posts and hooked center blade  
TS.11.139.02



**CASTROVIEJO LID CLAMP**  
With locking screw, solid blades  
TS.11.140.09

**JAEGER LID PLATE**  
Stainless steel  
TS.11.141.08

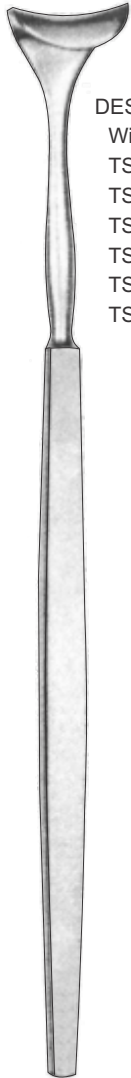

**DESMARRES LID RETRACTOR**  
 With solid blade (standard pattern)  
 TS.11.143.08 8 mm wide (Conway)  
 TS.11.144.10 10 mm wide # 0  
 TS.11.145.12 12 mm wide # 1  
 TS.11.146.14 14 mm wide # 2  
 TS.11.147.16 16 mm wide # 3  
 TS.11.148.18 18 mm wide # 4



**DESMARRES LID RETRACTOR**  
 With fenestrated blade (new pattern)  
 TS.11.149.12 12 mm wide # 1  
 TS.11.150.14 14 mm wide # 2



**SWISS PATTERN DISCISSION KNIFE**  
 Overall Length 120mm  
 TS.11.167.12



**KNAPP DISCISSION KNIFE**  
 Overall Length 120mm  
 TS.11.159.50 5.0 mm blade  
 TS.11.160.60 6.0 mm blade  
 TS.11.161.70 7.0 mm blade



**ZIEGLER DISCISSION KNIFE**  
 Overall Length 115mm  
 TS.11.162.20 2.0 mm blade  
 TS.11.163.30 3.0 mm blade  
 TS.11.164.50 5.0 mm blade  
 TS.11.165.60 6.0 mm blade



**WECKER DISCISSION KNIFE**  
 Overall Length 125mm  
 TS.11.166.12 Double adge



# Eye Instruments



WHEELER DISCISSION KNIFE  
Overall Length 115mm  
TS.11.168.18 18 mm cutting edge



BARKAN GONIOTOMY KNIFE  
Overall Length 120mm  
TS.11.169.12



SCHELE GONIOTOMY KNIFE  
Overall Length 125mm  
TS.11.170.12



CATARACT KNIFE  
Overall length 135mm  
TS.11.180.23 Blade 32 x 2.3 mm  
TS.11.181.26 Blade 35 x 2.6 mm  
TS.11.182.30 Blade 35 x 3.0 mm



JAEGER KERATOME ANGLED  
Overall length 135mm  
TS.11.184.10 10 x 10 mm  
TS.11.185.11 11 x 11 mm  
TS.11.186.12 12 x 12 mm  
TS.11.187.13 13 x 13 mm



DEUSCHMANN CATARACT KNIFE  
Overall Length 135mm  
TS.11.183.13



**JAMESON MUSCLE HOOK**  
 Overall length 140 mm  
 TS.11.193.01 Delicate  
 TS.11.194.02 Small  
 TS.11.195.03 Large



**GRAEFE STRABISMUS HOOK**  
 TS.11.196.01 # 1 small  
 TS.11.197.02 # 2 medium  
 TS.11.198.03 # 3 large



**STEVENS TENTONOMY HOOK**  
 Overall Length 120 mm,  
 blunt 6mm curved tip  
 TS.11.199.12



**GASS RETINAL  
 DETACHMENT HOOK**  
 Overall length 140 mm,  
 flat tip with oval hole  
 TS.11.200.14



**BURCH FIXATION PICK**  
 Overall length 130 mm,  
 with ball stop  
 TS.11.201.13



**TWIST FIXATION HOOK**  
 Overall length 120 mm,  
 for scleral fixation  
 TS.11.202.12R Right  
 TS.11.203.12L Left



**TYRELL IRIS HOOK**  
 Overall length 125 mm  
 TS.11.204.12 Sharp  
 TS.11.205.12 Blunt

# Eye Instruments



KNAPP LACRIMALSAC RETRACTOR  
Overall length 135mm, 4 blunt prongs  
TS.11.206.13



ROLLET LACRIMAL SAC RETRACTOR  
Overall length 135mm, 4 sharp prongs  
TS.11.207.13

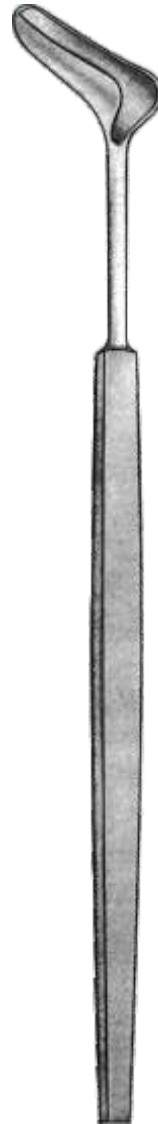

ARRUGA GLOBE RETRACTOR  
Overall length 145mm  
TS.11.208.14



SCHERPENS ORBITAL RETRACTOR  
Overall length 145mm, smooth forked blade  
TS.11.209.14



**SNELLEN LENS LOOP**  
 Overall length  
 140mm  
 TS.11.210.14  
 15 x 4 mm  
 smooth loop



**WILDER LENS LOOP**  
 Overall length  
 140mm  
 TS.11.211.14  
 15 x 4 mm  
 serrated loop



**KEENER-ARHT  
 LENS NUCLEUS LOOP**  
 Strong curved  
 3mm wide serrated  
 loop for small incision  
 nucleus fragment  
 removal  
 TS.11.212.03



**KANSAS LENS  
 NUCLEUS LOOP**  
 Light curved  
 3 mm wide  
 serrated loop  
 for small incision  
 nucleus fragment  
 removal  
 TS.11.213.03



**LEWIS LENS LOOP**  
 TS.11.214.01 Small  
 TS.11.215.02 Large



**MORRISON LENS  
 LOOP AND PROBE**  
 Very thin loop and  
 delicate olive tip  
 TS.11.216.02

# Eye Instruments

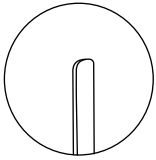

**KNOLLE LENS  
NUCLEUS SPATULA**  
Overall Length  
120 mm, flat  
0.5 mm wide blade  
TS.11.219.12

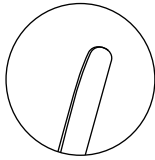

**SINSKEY LENS  
NUCLEUS SPATULA**  
Overall length  
120 mm, slightly  
curved 30 mm  
long narrow blade  
TS.11.220.12

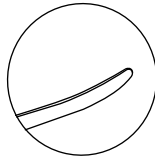

**GIRARD SYNECHIA  
SPATULA**  
Overall length  
115 mm, 0.5 mm  
wide 10mm  
vaulted blade  
TS.11.221.11

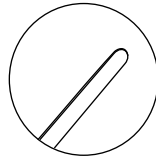

**JAFFE LENS  
SPATULA**  
Overall length  
115mm, smooth  
0.5mm wide 10 mm  
angled blade  
TS.11.222.11

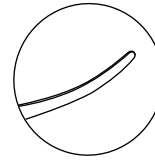

**JOHNSON SIDEPORT  
NUCLEUS SPATULA**  
Overall length  
115mm, 0.25 mm  
wide blade,  
10 mm vaulted  
shaft with sharp tip  
TS.11.223.11

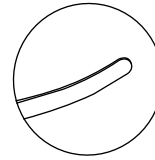

**BIRNBAUM LENS  
SPATULA**  
Overall length  
120 mm, 0.25 mm  
wide 10 mm  
vaulted blade  
TS.11.224.12



**MEYHÖFER CHALAZION CURETTE**

Overall length 130 mm,  
 sharp round cup  
 TS.11.248.05 ø 0.50 mm  
 TS.11.249.10 ø 1.00 mm  
 TS.11.250.15 ø 1.50 mm  
 TS.11.251.17 ø 1.75 mm  
 TS.11.252.20 ø 2.00 mm  
 TS.11.253.25 ø 2.50 mm  
 TS.11.254.30 ø 3.00 mm  
 TS.11.255.35 ø 3.50 mm

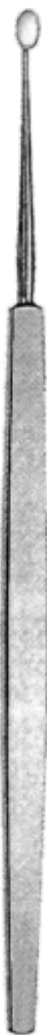

**HEBRA CHALAZION CURETTE**

Overall length 130 mm,  
 sharp oval cup  
 TS.11.255.10 ø 1.00 mm  
 TS.11.257.20 ø 2.00 mm  
 TS.11.258.25 ø 2.50 mm  
 TS.11.259.30 ø 3.00 mm  
 TS.11.260.35 ø 3.50 mm



**AXENFELD CHALAZION CURETTE**

Overall length  
 145 mm double ended  
 TS.11.261.14

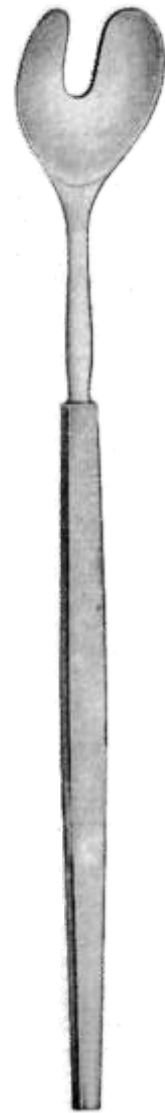

**WELLS ENUCLEATION SPOON**

Overall length 145 mm,  
 21 mm wide blade with  
 notch  
 TS.11.269.14

# Eye Instruments

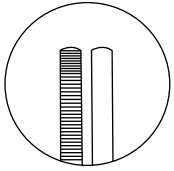

**Straight Dressing**  
Forceps with serration  
Overall length 100 mm  
TS.11.330.05 0.5 mm wide tips  
TS.11.330.07 0.7 mm wide tips  
TS.11.330.10 1.0 mm wide tips  
TS.11.330.12 1.2 mm wide tips  
TS.11.330.14 1.4 mm wide tips

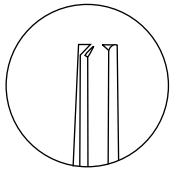

**Straight Tissue Forceps**  
with 1 x 2 teeth  
Overall length 100 mm  
TS.11.332.05 0.5 mm wide tips  
TS.11.332.07 0.7 mm wide tips  
TS.11.332.10 1.0 mm wide tips  
TS.11.332.12 1.2 mm wide tips  
TS.11.332.14 1.4 mm wide tips

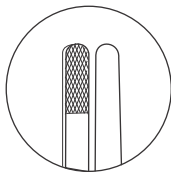

**BISHOP HARMON**  
Dressing Forceps  
Overall length 85 mm  
criss-cross serrated  
TS.11.333.06  
0.6 mm wide tips

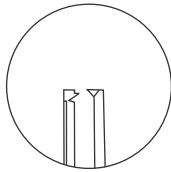

**BISHOP HARMON**  
Tissue Forceps  
Overall length  
85 mm 1 x 2 teeth  
TS.11.334.06 Delicate  
0.6 mm wide tips



**GENTLY CURVED DRESSING**  
 Forceps with serration  
 Overall length 100 mm  
 gently curved tips  
 TS.11.335.07  
 0.7 mm wide tips



**GENTLY CURVED**  
**TISSUE FORCEPS**  
 with 1 x 2 teeth  
 Overall length  
 100 mm gently  
 curved tips  
 TS.11.336.07  
 0.7 mm wide tips



**STRONG CURVED**  
**DRESSING FORCEPS**  
 with serration  
 Overall length 100 mm  
 strong curved tips  
 TS.11.337.07  
 0.7 mm wide tips



**STRONG CURVED**  
**TISSUE FORCEPS**  
 with 1 x 2 teeth  
 Overall length 100 mm  
 Strong curved tips  
 TS.11.338.07  
 0.7 mm wide tips

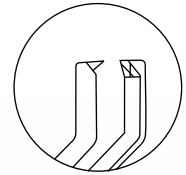

**ANGLED HESS**  
**IRIS FORCEPS**  
 Swiss pattern  
 1 x 2 teeth,  
 overall length  
 100 mm  
 TS.11.339.10



# Eye Instruments

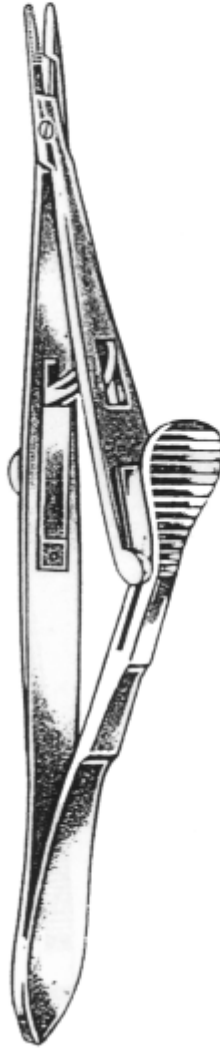
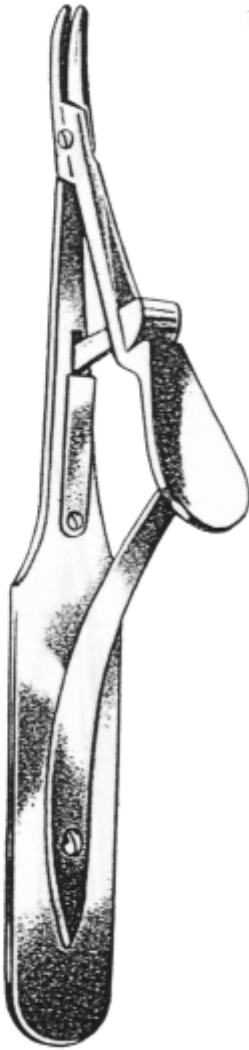
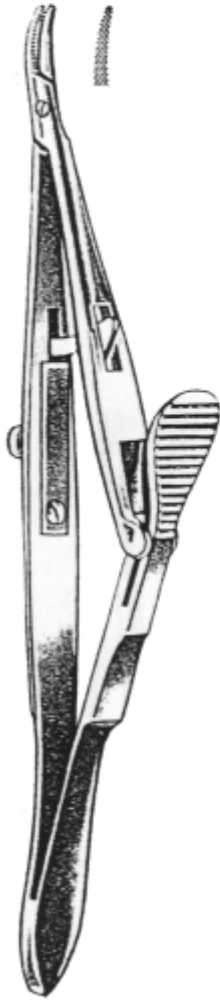

**KALT**

TS.11.550.13	TS.11.551.13
13cm/ 5½"	13cm/ 5½"
gerade	gebogen
straight	curved
recta	curva
droit	courbee

**ARRUGA**

TS.11.552.14	TS.11.553.14
14cm/ 5½"	14cm/ 5½"
gerade	gebogen
straight	curved
recta	curva
droit	courbee

**CASTROVIEJO KALT**

16cm/ 6¼"  
TS.11.555.16

**STEVENS**

14cm/ 5½"  
TS.11.554.14

# Eye Instruments

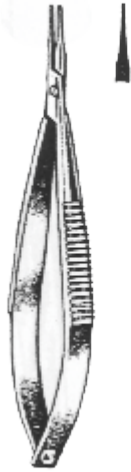

without catch

MICRO-CASTROVIEJO  
 TS.11.560.09  
 9cm/ 3½"

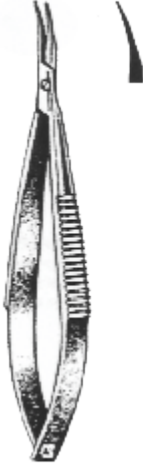

MICRO-CASTROVIEJO  
 TS.11.561.09  
 9cm/ 3½"

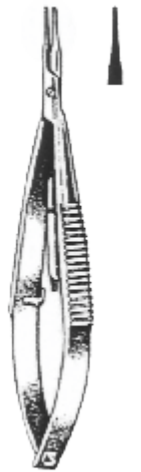

with catch

MICRO-CASTROVIEJO  
 TS.11.562.09  
 9cm/ 3½"

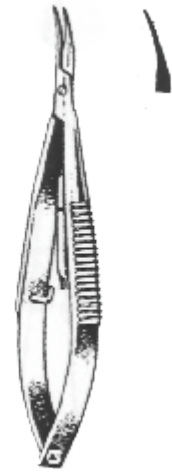

MICRO-CASTROVIEJO  
 TS.11.563.09  
 9cm/ 3½"

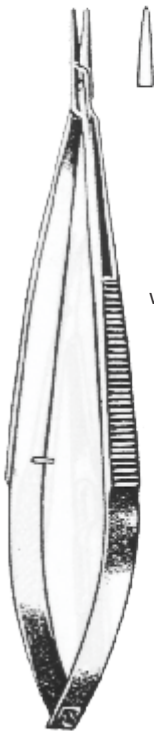

without catch

CASTROVIEJO  
 TS.11.564.14  
 14 cm/ 5½"

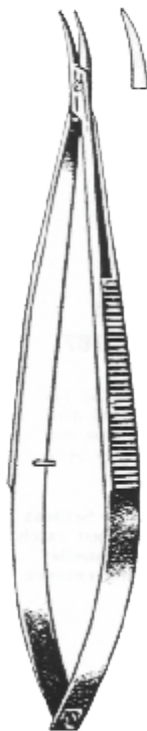

CASTROVIEJO  
 TS.11.565.14  
 14 cm/ 5½"

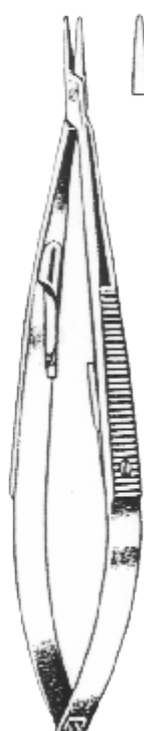

with catch

CASTROVIEJO  
 TS.11.566.14  
 14 cm/ 5½"

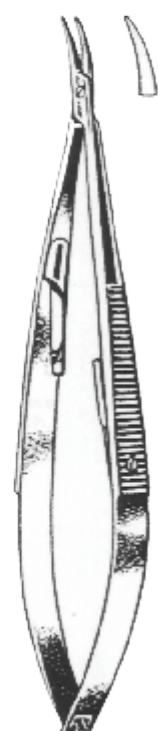

CASTROVIEJO  
 TS.11.567.14  
 14 cm/ 5½"

# Eye Instruments

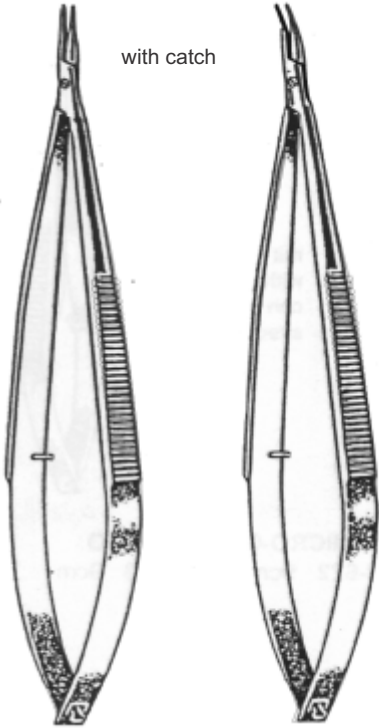

with catch

MICRO-CASTROVIEJO  
TS.11.570.14      TS.11.571.14  
14cm/ 5½"      14cm/ 5½"

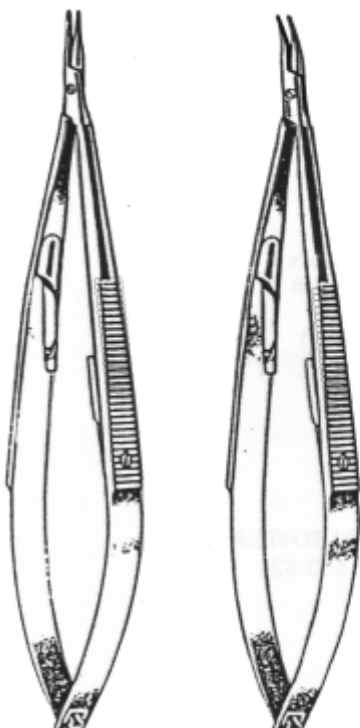

MICRO-CASTROVIEJO  
TS.11.572.14      TS.11.573.14  
14cm/ 5½"      14cm/ 5½"

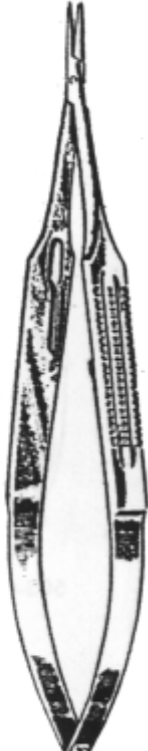

CASTROVIEJO  
TS.11.574.14  
14cm/ 5½"



without catch

TS.11.575.10  
10 cm/ 4"



without catch

BARRAQUER  
TS.11.576.13      TS.11.577.13  
13cm/ 5⅙"      13cm/ 5⅙"



with catch

BARRAQUER  
TS.11.578.13      TS.11.579.13  
13cm/ 5⅙"      13cm/ 5⅙"

# Eye Instruments



Lacrimal cannula, SS

TS.11.760.01

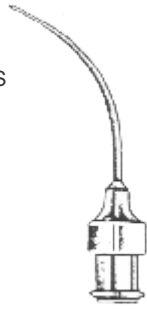

TS.11.761.01



TS.11.762.01



TS.11.763.01

Lacrimal cannula with 2 lateral holes

Retrobulbar needle, 40mm x 0.6mm Alpha - Chymotrypsin cannula



MC INTYRE  
TS.11.764.40



MC INTYRE  
TS.11.765.21



ATKINSON  
TS.11.766.40



TROUTMAN  
TS.11.767.01

Cyclodialysis cannula

Cyclodialysis cannula

Cyclodialysis cannula

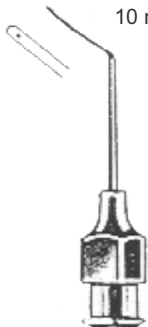

10 mm

TS.11.768.10



15 mm

TS.11.769.15



Right side opening

TS.11.770.11



Left side opening

TS.11.771.12



TS.11.772.31

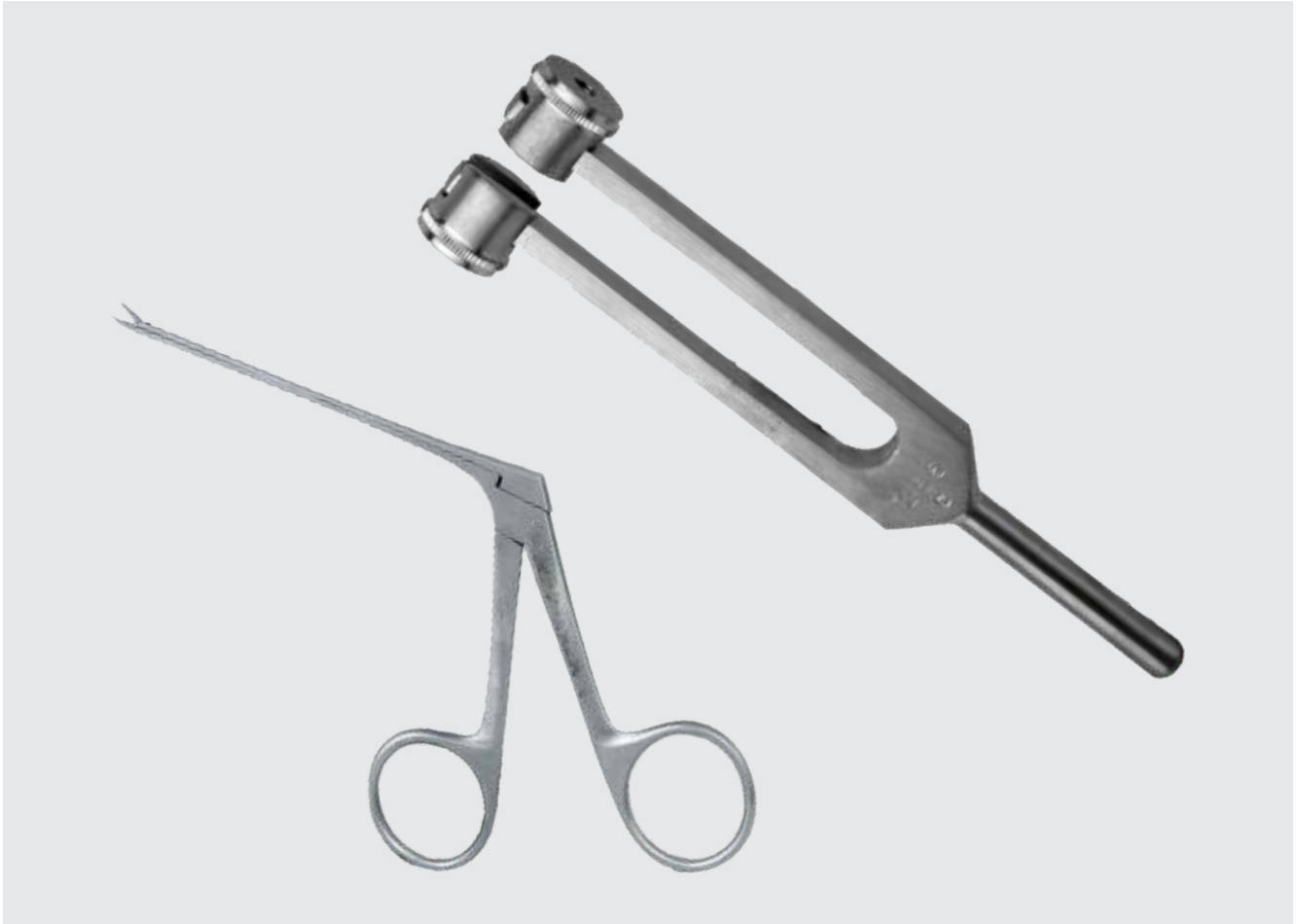

Otology

# Otology Instruments



**KRAUSE**  
 TS.11.07.16  
 16 cm/ 6¼"



**WILDE**  
 TS.11.07.26  
 16 cm/ 6¼"



**EVE**  
 TS.11.07.28  
 28 cm/ 11"



**EVE**  
 TS.11.08.28  
 28 cm/ 11"



TS.11.07.42    Ø 0.2 mm  
 TS.11.07.43    Ø 0.3 mm



TS.11.07.47    Ø 0.2 mm  
 TS.11.07.48    Ø 0.3 mm  
 TS.11.07.49    Ø 0.35 mm

Snare wire, coli/10 meters (33.3.ft.)

Snare loops,pre-shaped, bundle/100 pieces

# Otology Instruments



TS.11.11.10  
C-128



TS.11.11.11  
C<sup>1</sup>-256



TS.11.11.12  
C<sup>2</sup>-512



TS.11.11.13  
C<sup>3</sup>-1024



TS.11.11.14  
C<sup>4</sup>-2048



TS.11.11.15  
C<sup>5</sup>-4096

HARTMANN

ALU Tuning Forks, made of special aluminium alloy

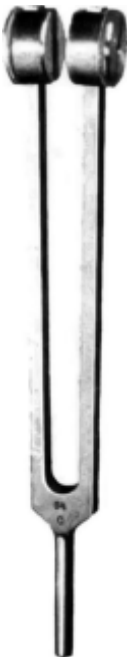

TS.11.12.64  
C-64



TS.11.13.28  
C-128



TS.11.14.56  
C<sup>1</sup>-256



TS.11.15.12  
C<sup>2</sup>-512



TS.11.16.24  
C<sup>3</sup>-1024



TS.11.17.48  
C<sup>4</sup>-2048



TS.11.18.96  
C<sup>5</sup>-4096

ALU

# Otology Instruments



TS.11.18.10  
C-128



TS.11.18.11  
C¹-256



TS.11.18.12  
C²-512



TS.11.18.13  
C³-1024



TS.11.18.14  
C⁴-2048



TS.11.18.15  
C⁵-4096

LUCAE

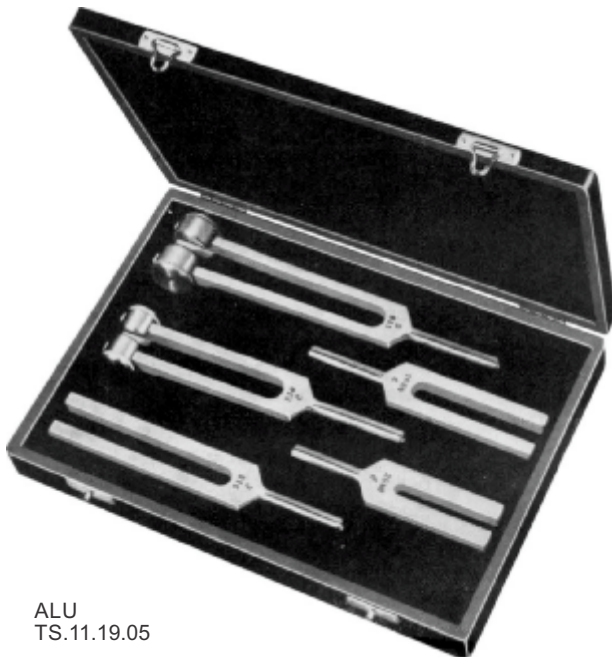

ALU  
TS.11.19.05

ALU Set of 5 Tuning Forks,  
in case, consisting of:



# Otology Instruments



GARDINER BROWN  
TS.11.19.20  
C-128



GARDINER BROWN  
TS.11.19.21  
C-256



GARDINER BROWN  
TS.11.19.22  
C-512



GARDINER BROWN  
TS.11.19.23  
C-1024

# Otology Instruments

For children



HARTMANN  
(For Children)  
TS.11.28.07  
Set of 3 (Fig

○  
TS.11.28.30  
#0 - Ø 3 mm

○  
TS.11.28.40  
#1 - Ø 4 mm

○  
TS.11.28.50  
#2 - Ø 5 mm

For adults



HARTMANN (For Adults)  
TS.11.28.03 Set of 3 (Fig 2,3,4)  
TS.11.28.04 Set of 4 (Fig 1,2,3,4)

○  
TS.11.28.40  
#1 - Ø 4 mm

○  
TS.11.28.50  
#2 - Ø 5 mm

○  
TS.11.28.60  
#3 - Ø 6 mm

○  
TS.11.28.75  
#4 - Ø 7.5 mm

For adults



HARTMANN  
(For Adults)

○  
TS.11.28.55  
#1 - Ø 5 mm

○  
TS.11.28.65  
#2 - Ø 6 mm

○  
TS.11.28.75  
#3 - Ø 7.5 mm

For adults



TS.11.28.10  
BOUCHERON

Set/4 sizes (# 1 – 4)

○  
TS.11.28.84  
#1 - Ø 4.5 mm

○  
TS.11.28.85  
#2 - Ø 5.5 mm

○  
TS.11.28.86  
#3 - Ø 6.5 mm

○  
TS.11.28.87  
#4 - Ø 7.5 mm

○  
TS.11.30.45  
#1 - Ø 4.5 mm

○  
TS.11.30.55  
#2 - Ø 5.5 mm

○  
TS.11.30.65  
#3 - Ø 6.5 mm

○  
TS.11.30.75  
#4 - Ø 7.5 mm



GRUBER  
TS.11.30.20

Set/4 sizes (# 1 – 4)

# Otology Instruments

For adults



TOYNBEE  
TS.11.32.03

Set/3 sizes (# 2 – 4)



TS.11.32.45  
#1 - Ø 4.5 mm



TS.11.32.55  
#2 - Ø 5.5 mm



TS.11.32.65  
#3 - Ø 6.5 mm



TS.11.32.75  
#4 - Ø 7.5 mm

For adults



TOYNBEE  
TS.11.32.04

Set/4 sizes (# 1 – 4)



FARRIOR  
(BLACK)  
TS.11.34.55-PAC.34.97



TS.11.34.55  
Ø 5.5 mm



TS.11.34.65  
Ø 6.5 mm



TS.11.34.75  
Ø 7.5 mm



TS.11.34.85  
Ø 8.5 mm



TS.11.34.95  
Ø 9.5 mm



TS.11.34.96  
Ø 10.5 mm



TS.11.34.97  
Ø 11.5 mm



Ø 3.0 mm  
TS.11.35.30  
Fig. 1



Ø 4.5 mm  
TS.11.35.45  
Fig. 2



Ø 5.5 mm  
TS.11.35.55  
Fig. 3



Ø 6.5 mm  
TS.11.35.65  
Fig. 4



POLITZER  
TS.11.35.51  
Set of 3 (Fig. 1,2,3)

TS.11.35.52  
Set of 4 (Fig. 1,2,3),4



TS.11.35.70  
ZOELLNER

Set / 6 sizes (# 1 - 6)



TS.11.35.71  
#1 - 5.5 x 6.5 mm



TS.11.35.72  
#2 - 6.5 x 7.5 mm



TS.11.35.73  
#3 - 7.5 x 8.5 mm



TS.11.35.74  
#4 - 8.5 x 9.5 mm



TS.11.35.75  
#5 - 9.5 x 10.5 mm



TS.11.35.76  
#6 - 10.5 x 11.5 mm



PAPARELLA  
TS.11.35.93  
13 cm / 5 1/4"

# Otology Instruments

Length of shaft 80 mm (3 1/8")

Length of shaft 60 mm (2 1/8")



Chisel-edged punch



Atticus punch

TS.11.38.04  
4 mm

TS.11.38.06  
6 mm



# Otology Instruments



WULLSTEIN  
 TS.11.54.17  
 17 cm / 6¾"

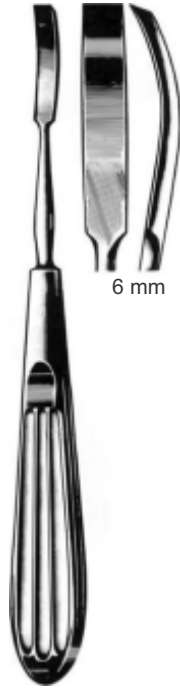

LEMPERT  
 TS.11.55.17  
 18 cm / 7¼"



LEMPERT  
 TS.11.54.20  
 20 cm / 8"

12mm



JANSEN  
 TS.11.55.27  
 17 cm / 6¾"

13mm



VOSS  
 TS.11.55.33  
 15 cm / 6"

# Otology Instruments

Periosteal Knife



MUCK  
TS.11.55.43  
13 cm - 5 1/8"

Mastoid Knife



POLITZER  
TS.11.55.53  
13 cm / 5 1/8"



LEMPERT  
18 cm - 7 1/8"



TS.11.55.62  
2 mm



TS.11.55.63  
3 mm



TS.11.55.64  
4 mm

# Otology Instruments



**HARTMANN**  
 14 cm / 5½"



TS.11.63.07  
 # 1 - Ø 2.5 mm



TS.11.63.09  
 # 2 - Ø 3 mm



TS.11.63.11  
 # 3 - Ø 3.5 mm



TS.11.63.12  
 # 4 - Ø 4 mm



TS.11.63.15  
 # 5 - Ø 5 mm



Graduated

**TROELTSCH**  
 14 cm / 5½"



TS.11.63.21  
 # 1 - Ø 2.5 mm



TS.11.63.22  
 # 2 - Ø 3 mm



TS.11.63.23  
 # 3 - Ø 3.5 mm



TS.11.63.24  
 # 4 - Ø 4 mm



TS.11.63.25  
 # 5 - Ø 5 mm



TS.11.63.30

Olive-shaped tube connector for Hartmann and troeltsch ear catheters



# Otology Instruments

WULLSTEIN irrigating suction  
Handle, with Luer cone,  
For WULLSTEIN irrigating or suction tubes



WULLSTEIN  
TS.11.63.46

#1 ●  
#2 ●

Working length 110mm-4 $\frac{3}{8}$ "



FRAZIER (FERGUSSON)  
PAC-63.51 #1-Ø 1.00 mm X 190 mm  
TS.11.63.52 #2-Ø 2.00 mm X 190 mm

ZÖLLNER suction tube with finger  
Plate, complete with  
1 slip-on cannula, 0.7mm diameter



With LUER cone

Aspirating tube only  
(Without cannula)

ZÖLLNER  
TS.11.63.61



ZÖLLNER  
TS.11.63.65 Ø 0.5mm  
TS.11.63.67 Ø 0.7mm

Micro Suction Cannula only  
for Suction Tube, working length 30 mm

# Otology Instruments



HOUSE  
 TS.11.63.71 # 1 - Ø 0.9 + 0.7 mm  
 TS.11.63.72 # 2 - Ø 1.2 + 0.9 mm  
 TS.11.63.73 # 3 - Ø 1.5 + 1.2 mm

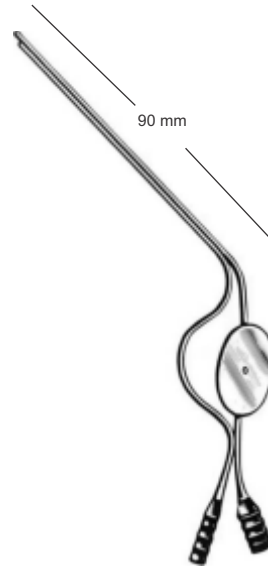

TS.11.63.81 # 1 - Ø 1.8 + 1.8 mm  
 TS.11.63.82 # 2 - Ø 2.5 + 2.0 mm  
 TS.11.63.83 # 3 - Ø 3.0 + 2.0 mm  
 TS.11.63.84 # 4 - Ø 4.5 + 2.0 mm

For the right ear

For the left ear



HARTMANN  
 TS.11.63.91  
 #1



HARTMANN  
 TS.11.63.92  
 #2

# Otology Instruments

with LUER-LOCK attachment



**ROSEN**  
TS.11.64.01 Ø 0.70 x 80 mm  
TS.11.64.02 Ø 0.90 x 80 mm  
TS.11.64.03 Ø 1.20 x 80 mm

with LUER-LOCK attachment



**ROSEN**  
TS.11.64.11 Ø 0.70 x 65 mm  
TS.11.64.12 Ø 0.90 x 65 mm  
TS.11.64.13 Ø 1.20 x 65 mm  
TS.11.64.14 Ø 1.50 x 65 mm  
TS.11.64.15 Ø 2.00 x 65 mm

with finger cut-off

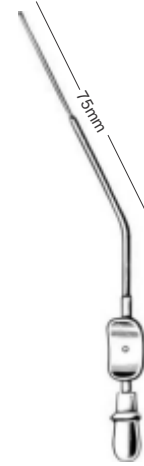

**BARON (SCHUKNECHT)**  
TS.11.64.20 Ø 1.0 x 75 mm  
TS.11.64.25 Ø 1.5 x 75 mm  
TS.11.64.30 Ø 2.0 x 75 mm



**WULLSTEIN**  
TS.11.64.41 Ø 1.5 mm  
TS.11.64.42 Ø 2.0 mm  
16 cm/ 6¼"

Flexible

With luer cone

Sterling silver



**WULLSTEIN**  
TS.11.64.43  
16 cm/ 6¼"  
Ø 1.5 mm



TS.11.64.48

Tube connector with luer cone and cut-off plate, for WULLSTEIN and ROSEN suction tubes

# Otology Instruments

TS.11.66.11

TS.11.66.10



TS.11.66.12

All metal ear syringe, complete with 2 attachments and 1 protecting plate, with LUER LOCK attachment

LUER-LOCK  
 TS.11.66.02 50 ml  
 TS.11.66.03 75 ml  
 TS.11.66.04 100 ml

TS.11.66.11

Conical attachment only,  
 With luer-lock cone

TS.11.66.12

Olive-shaped attachment only,  
 With luer-lock cone

TS.11.66.10

Protective plate only, Ø 58 mm,  
 With luer-lock cone

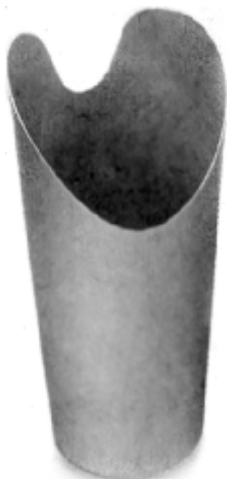















TS.11.66.50  
 EAR NOOTS TANK  
 Aluminium

# Otology Instruments

















BUCK  
15 cm/ 6"

sharp		blunt	
			
TS.11.70.09 # 00 - Ø 1.5 mm	TS.11.70.02 # 2 - Ø 2.7 mm	TS.11.70.29 # 00 - Ø 1.5 mm	TS.11.70.22 # 2 - Ø 2.7 mm
			
TS.11.70.00 # 0 - Ø 1.9 mm	TS.11.70.03 # 3 - Ø 3.4 mm	TS.11.70.20 # 0 - Ø 1.9 mm	TS.11.70.23 # 3 - Ø 3.4 mm
			
TS.11.70.01 # 1 - Ø 2.5 mm	TS.11.70.04 # 4 - Ø 4.0 mm	TS.11.70.21 # 1 - Ø 2.5 mm	TS.11.70.24 # 4 - Ø 4.0 mm
			
	TS.11.70.05 # 5 - Ø 4.5 mm		TS.11.70.25 # 5 - Ø 4.5 mm

Ø = Inside diameter



BUCK  
15 cm-6"

sharp		blunt	
			
TS.11.70.39 # 00 - Ø 1.5 mm	TS.11.70.42 # 2 - Ø 2.7 mm	TS.11.70.59 # 00 - Ø 1.5 mm	TS.11.70.62 # 2 - Ø 2.7 mm
			
TS.11.70.40 # 0 - Ø 1.9 mm	TS.11.70.43 # 3 - Ø 3.4 mm	TS.11.70.60 # 0 - Ø 1.9 mm	TS.11.70.63 # 3 - Ø 3.4 mm
			
TS.11.70.41 # 1 - Ø 2.5 mm	TS.11.70.44 # 4 - Ø 4.0 mm	TS.11.70.61 # 1 - Ø 2.5 mm	TS.11.70.64 # 4 - Ø 4.0 mm
			
	TS.11.70.45 # 5 - Ø 4.5 mm		TS.11.70.65 # 5 - Ø 4.5 mm

# Otology Instruments



**BUCK-WULLSTEIN  
 MICRO**  
 16 cm/ 6¼"

sharp

blunt

sharp		blunt	
○ TS.11.70.69 # 0000 Ø 0.9 mm	○ TS.11.70.72 # 0 Ø 1.8 mm	○ TS.11.70.79 # 0000 Ø 0.9 mm	○ TS.11.70.82 # 0 Ø 1.8 mm
○ TS.11.70.70 # 000 Ø 1.1 mm	○ TS.11.70.73 # 1 Ø 2.1 mm	○ TS.11.70.80 # 000 Ø 1.1 mm	○ TS.11.70.83 # 1 Ø 2.1 mm
○ TS.11.70.71 # 00 Ø 1.3 mm		○ TS.11.70.81 # 00 Ø 1.3 mm	

∅ = Inside diameter



**BILLEAU**  
 15.5 cm-6¼"

- TS.11.71.10  
# 1
- TS.11.71.20  
# 2
- TS.11.71.30  
# 3



**BILLEAU MICRO**  
 16 cm-6¼"

- TS.11.71.42  
# 00 - 2.0 mm
- TS.11.71.45  
# 0 - 2.5 mm
- TS.11.71.47  
# 1 - 3.0 mm

# Otology Instruments

Ear curette and hook



GROSS  
TS.11.72.35  
12 cm/ 4¾"



JANSEN  
15 cm/ 6"

Ear spoon and hook



GROSS  
TS.11.72.45  
12 cm/ 4¾"



ALLPORT  
TS.11.62.16  
16 cm/ 6¼"

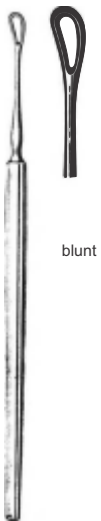

LANGENBECK  
TS.11.75.13  
13.5 cm/ 5¾"

blunt

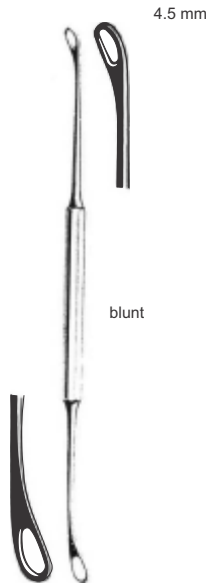

COXETER  
TS.11.75.15  
14.5 cm/ 5¾"



WEBER-LOCH  
15 cm/ 6"

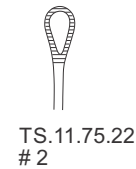
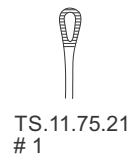
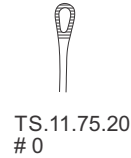

Serrated

# Otology Instruments



**SHAPLEIGH**  
 14 cm/ 5½"



TS.11.76.01  
 # 1



TS.11.76.02  
 # 2



TS.11.76.03  
 # 3



TS.11.76.04  
 # 4

serrated



**MOLDENHAUER**  
 TS.11.77.16  
 16 cm/ 6¼"



**ZAUFAL**  
 TS.11.78.16  
 16 cm/ 6¼"



**WAGENER**  
 14 cm/ 5½"



TS.11.79.05  
 2.0 mm



TS.11.79.04  
 2.5 mm



TS.11.79.03  
 3.0 mm



TS.11.79.02  
 3.5 mm



TS.11.79.01  
 4.0 mm



# Otology Instruments



TS.11.79.06

sharp

WAGNER  
14 cm/ 5½"



TS.11.79.07

blunt



YANKAUER-JANSEN  
TS.11.79.15  
45°, 15 cm/ 6"



HARTMANN  
16 cm/ 6¼"



TS.11.79.21  
#1



TS.11.79.22  
#2



TS.11.80.01  
fig.1

LUCAS  
14 cm/ 5½"



TS.11.80.02  
fig.2

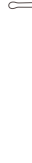

TS.11.80.03  
fig.3



DAY  
16 cm/ 6¼"



TS.11.81.01



TS.11.81.02

# Otology Instruments

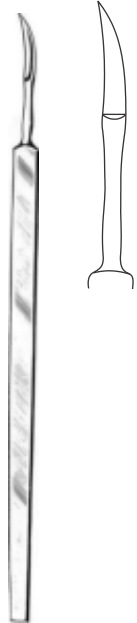

LEMPERT  
 TS.11.82.16  
 16cm/ 6¼"

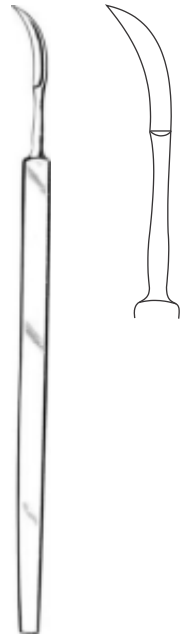

LEMPERT  
 TS.11.82.17  
 17cm/ 6¾"

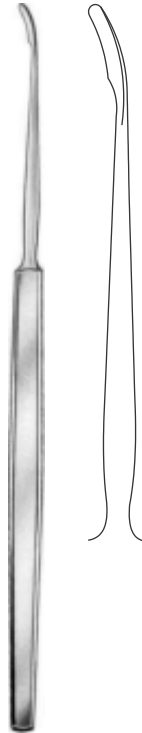

TS.11.82.19  
 19cm/ 7½"

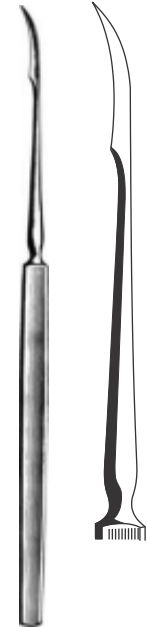

POLITZER  
 TS.11.82.26  
 16cm/ 6¼"

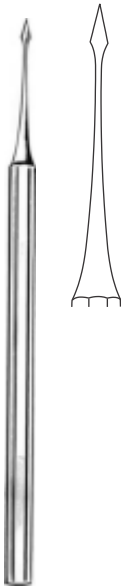

LEMPERT  
 TS.11.82.35  
 15cm/ 6"

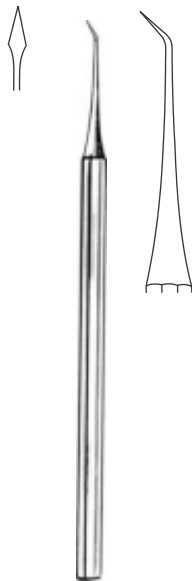

LEMPERT  
 TS.11.82.45  
 45°, 15cm/ 6"

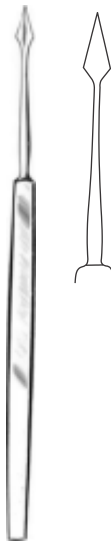

LEMPERT  
 TS.11.82.54  
 14cm/ 5½"

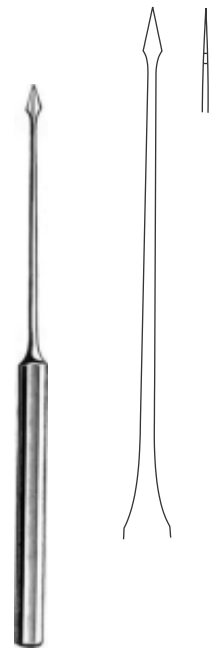

BUCK  
 TS.11.82.55  
 15cm/ 6"

# Otology Instruments



SEXTON  
TS.11.82.58  
18cm/ 7¼"



SEXTON  
TS.11.82.59  
18cm/ 7¼"



SEXTON  
TS.11.82.60  
18cm/ 7¼"



SEXTON  
TS.11.82.61  
18cm/ 7¼"



SEXTON  
TS.11.82.62  
18cm/ 7¼"



with screw-locking handle

SEXTON  
TS.11.82.63  
16cm/ 6¼"

# Otology Instruments



for children

**LUCAE (ROYCE)**  
 TS.11.83.07  
 18cm/ 7¼"



for adults

**LUCAE (ROYCE)**  
 TS.11.83.06  
 18cm/ 7¼"



**POLITZER (ROYCE)**  
 TS.11.84.04  
 16cm/ 6¼"



**POLITZER**  
 TS.11.85.16  
 16cm/ 6¼"



with screw-locking handle

**POLITZER**  
 TS.11.89.20  
 15cm/ 6"



**LUCAE**  
 TS.11.89.21  
 19cm/ 7½"

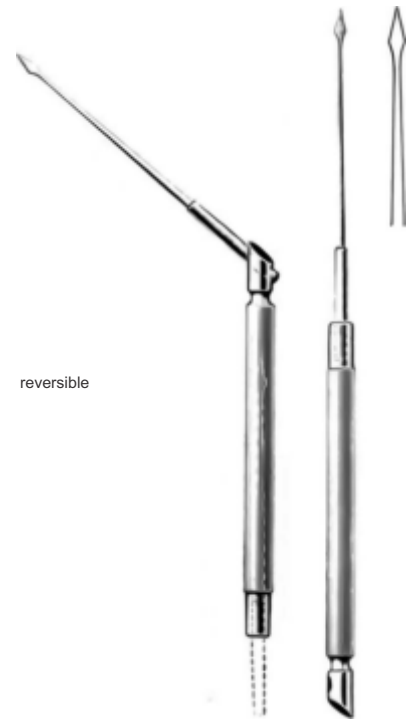

reversible

**POLITZER**  
 TS.11.89.29  
 19cm/ 7½"

# Otology Instruments



TS.12.90.61



TS.12.90.62



TS.12.90.63



TS.12.90.64



TS.12.90.65



TS.12.90.66

TS.12.90.60  
SPRAGUE

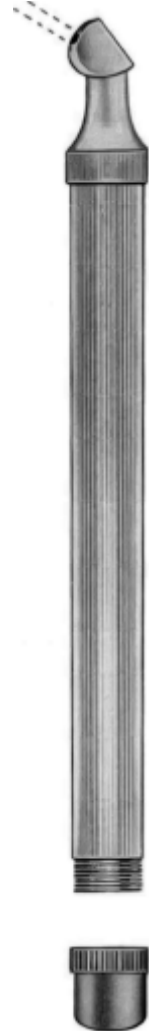

SPRAGUE Ear Instrument set, complete, composed of: 1 Tubular handle with 6 interchangeable Attachments: 1 sickle-shaped knife 1 blunt-tipped hook, no.TS.12.90.62: 1 button-tipped probe no. TS.12.90.63: 1 Tympanum perforating lancet no.TS.12.90.64: 1 ear curette no. TS.12.90.65: 1 ear spoon no.TS.12.90.66.

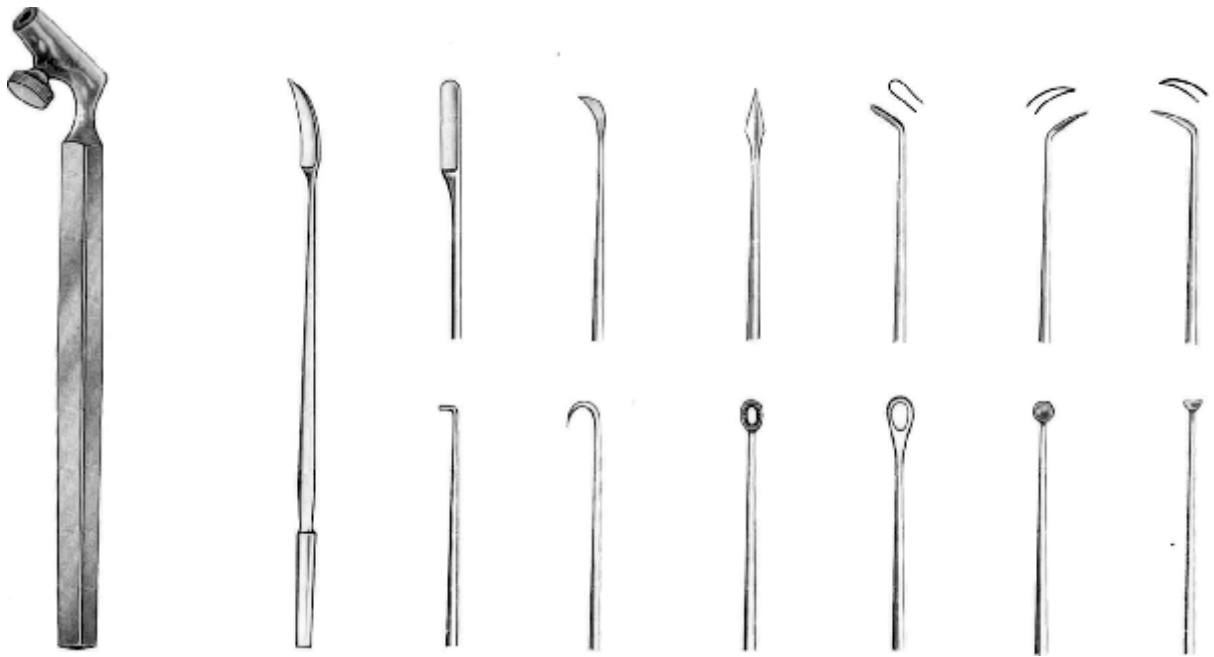

HARTMANN  
TS.12.90.76

HARTMANN ear instrument set, complete, consisting of: 1 handle and 13 interchangeable attachments, in metal case

# Otology Instruments

Foreign body forceps



**BUCK**  
TS.12.96.30  
13 cm/ 5¼"

Foreign body leaver

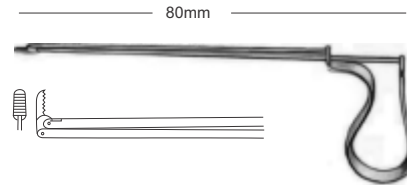

**QUIRE**  
TS.12.97.32  
10 cm/ 4"

Ear Dressing Forceps

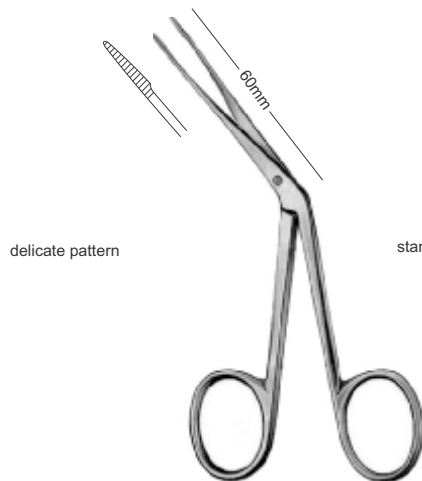

**HARTMANN**  
TS.12.105.45  
13.5 cm/ 5¼"

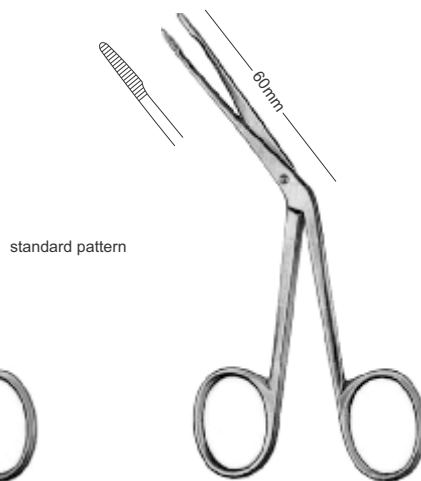

**HARTMANN**  
TS.12.105.50  
13.5 cm/ 5¼"

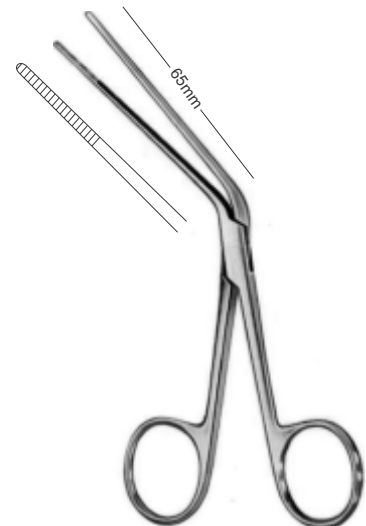

**TILLEY**  
TS.12.105.64  
14 cm/ 5½"

# Otology Instruments

medium fine  
modelo médio fino  
demi fine



HARTMANN  
TS.12.100.01  
14 cm/ 5½"  
serrated jaws



HARTMANN  
TS.12.100.02  
14 cm/ 5½"  
serrated jaws



HARTMANN  
TS.12.100.03  
14 cm/ 5½"  
smooth jaws



HARTMANN  
TS.12.100.04  
14 cm/ 5½"  
smooth jaws, 1 x 2 teeth

heavy pattern



BELLUCCI  
TS.12.101.05

Grasping Forceps, may also be used as  
Prosthesis applying forceps or as wire bending forceps.



# Otology Instruments



HARTMANN  
TS.12.103.35  
14 cm / 5½"

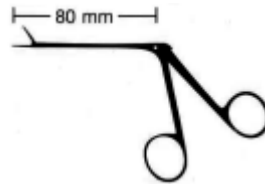

HARTMANN  
TS.12.103.37  
20 cm / 8"

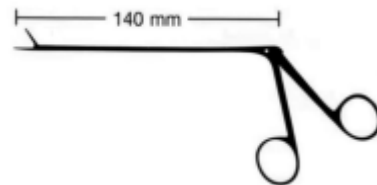

HARTMANN  
TS.12.103.38  
22 cm / 8¾"

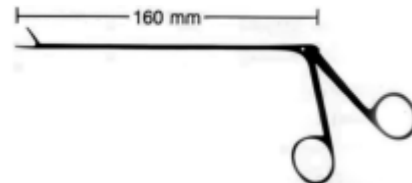

# Otology Instruments



**HARTMANN-NOYES**  
 TS.12.110.09  
 14 cm/ 5½"



**TS.12.111.14**  
 14 cm/ 5½"  
 "Duckbill"



**HARTMANN**  
 TS.12.104.40  
 14 cm/ 5½"  
 1 x 2 teeth



**WEINGÄRTNER**  
 TS.12.112.85  
 14 cm/ 5½"



**HARTMANN-HERZFELD**  
 TS.12.115.01 Ø 2 mm  
 TS.12.115.02 Ø 2.2 mm  
 TS.12.115.03 Ø 2.5 mm  
 TS.12.115.04 Ø 3 mm  
 14 cm/ 5½"



**HARTMANN-HERZFELD**  
 TS.12.117.01 Ø 2 mm  
 TS.12.117.02 Ø 2.2 mm  
 TS.12.117.03 Ø 2.5 mm  
 TS.12.117.04 Ø 3 mm  
 14 cm/ 5½"

# Otology Instruments



**HARTMANN**  
TS.12.113.08  
14 cm/ 5½"



**STRUEMPEL**  
TS.12.120.08  
14 cm/ 5½"



**STRUEMPEL-BABY**  
TS.12.120.09  
14 cm/ 5½"

Ø 2.0 mm



**HARTMANN**  
TS.12.125.08

Ø 2.0 mm



**HARTMANN**  
TS.12.125.09

1 X 0.9 mm



**TS.12.150.01**  
With oval cup jaws

1 X 0.9 mm



**TS.12.150.02**  
With oval cup jaws

1 X 0.9 mm



**TS.12.150.03**  
With oval cup jaws

1 X 0.9 mm



**TS.12.150.04**  
With oval cup jaws

# Otology Instruments

extremely delicate



dismantable shaft

4 X 0.5 mm



TS.12.131.10  
smooth jaws

4 X 0.5 mm



TS.12.132.16  
serrated jaws

3 X 0.5 mm



TS.12.132.17  
serrated jaws

3 X 0.5 mm



TS.12.132.18  
serrated jaws

3 X 0.5 mm



TS.12.132.19  
serrated jaws

7 X 0.5 mm



TS.12.132.22  
serrated jaws

4 X 0.4 mm



TS.12.133.12  
serrated jaws

4 X 0.4 mm



TS.12.133.14  
serrated jaws

0.6 X 0.5 mm



TS.12.134.32  
with oval cup jaws

0.6 X 0.5 mm



TS.12.134.34  
with oval cup jaws

0.6 X 0.5 mm



TS.12.134.36  
with oval cup jaws

0.6 X 0.5 mm



TS.12.134.37  
with oval cup jaws

# Otology Instruments

delicate



dismantable shaft

5 X 0.5 mm



TS.12.135.12  
serrated jaws

4 X 0.5 mm



TS.12.135.14  
serrated jaws

7 X 0.5 mm



TS.12.135.33  
serrated jaws

Ø 0.9 mm



TS.12.135.40  
with oval cup jaws

1.2 X 0.9 mm



TS.12.135.25  
with oval cup jaws

5 X 2 mm



TS.12.135.30  
jaws fenestrated

# Otology Instruments

delicate



BELLUCCI  
 PAG140.00  
 Sharp/blunt tip, straight



BELLUCCI  
 PAG140.01  
 sharp-tipped blades, straight



BELLUCCI  
 PAG140.02  
 sharp tips, angled up

cutting blades 4 mm long



BELLUCCI  
 PAG140.03  
 Sharp tips, curved right



BELLUCCI  
 PAG140.04  
 sharp tips, curved left

# Otology Instruments

delicate pattern



cutting blades 8 mm long



SHEA-BELLUCCI  
PAG140.10  
blunt-tipped blades, straight



SHEA-BELLUCCI  
PAG140.12  
Sharp-tipped blades, straight



SHEA-BELLUCCI  
PAG140.16  
semisharp tips, curved right



SHEA-BELLUCCI  
PAG140.17  
semisharp tips, curved left

# Otology Instruments

delicate

with tubular shaft



Cutting blades 4mm long



TS.12.152.01  
sharp-tipped blades, straight



TS.12.152.02  
sharp tips, angled up



TS.12.152.03  
sharp tips, curved right



TS.12.152.02  
sharp tips, curved left



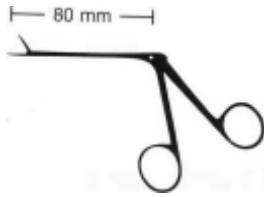

SCHUKNECHT  
TS.12.161.11

Wire crimper for closing wire loop of prostheses  
After attachment to incus or malleus.  
A groove In the rear part of the crimper jaws  
Prevents the wire loop from crushing when closing  
The forceps. Jaws slightly curved downwards

3.5 x 0.8 mm



PAG160.01

4.5 x 0.8 mm



TS.12.160.02



Dismantable shaft

MCGEE

Wire bending forceps, for application of Teflon-wire prostheses.  
Jaws slightly curved downwards.

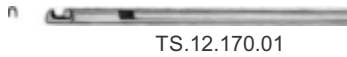
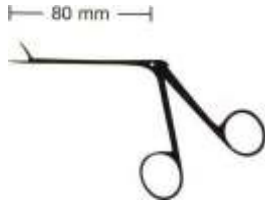

TS.12.170.01

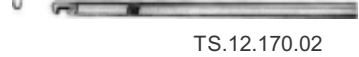

TS.12.170.02



TS.12.170.03



TS.12.170.04

3 x 2 mm



DAVOL  
TS.12.171.05



DIETER

Rongeur forceps for removing the bony Posterior canal wall for better access to incus and stapes.

Malleus punch, chisel-edge, 1.3mm wide

TS.12.170.01  
nach oben schneidend, up cutting,

TS.12.170.02  
nach unten schneidend, down cut

TS.12.170.03  
nach rechts schneidend, right cutting,

TS.12.170.04  
nach links schneidend, left cutting,

# Otology Instruments



LEMPERT  
TS.12.172.11  
11.5 cm/ 4½"

Malleus forceps



WULLSTEIN  
TS.12.172.35  
15 cm/ 6"

Malleus nipper,  
Chisel edge 3 mm long,  
Length of shaft 80mm (3½")

# Otology Instruments



FULLER  
 TS.12.173.19

Forceps for holding and inserting stapedial prostheses of Teflon, Plain jaws 6 x 0.8mm, length of shaft 75mm (3")



GREVEN  
 TS.12.173.30

Grasping forceps for the removal of otosclerotic proliferations (also, suitable for inserting Prostheses into the inner ear and for setting Drainage buttons), front part of jaws serrated, 3 x 1 mm, length of shaft 70 mm ( 2 ¾)



TABB  
 TS.12.173.22

Tabb crura nipper alligator type, for crurotomy And removal of footplate fragments in the oval Window area, width of shaft 1.5mm, usable length of shaft 65 mm

# Otology Instruments



**ANTOLI-CANDELA**  
 TS.12.200.10 Ø 1.0 mm  
 TS.12.200.15 Ø 1.5 mm  
 TS.12.200.20 Ø 2.0 mm  
 TS.12.200.23 Ø 2.3 mm  
 TS.12.200.25 Ø 2.5 mm

Incision Knife

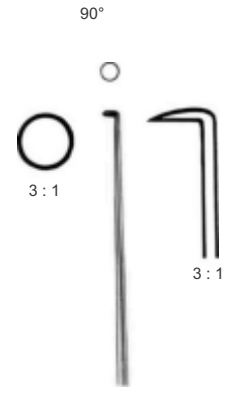

TS.12.200.30 Ø 1.0 mm  
 TS.12.200.35 Ø 1.5 mm  
 TS.12.200.40 Ø 2.0 mm  
 TS.12.200.43 Ø 2.3 mm  
 TS.12.200.45 Ø 2.5 mm

Circular cutting knife

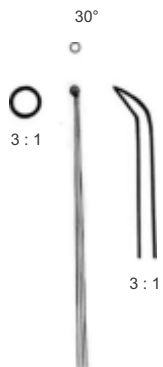

**HOUSE**  
 TS.12.201.01  
 Ø 1.0 mm

Round knife for incudo-stapedial joint

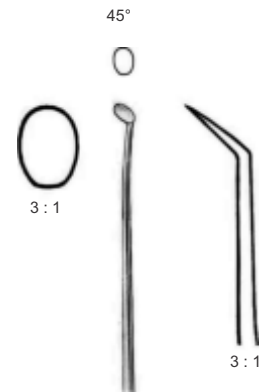

**GOLDMANN**  
 TS.12.201.03  
 Ø 3.0 mm

Knife-elevator for meatal wall

# Otology Instruments



# Otology Instruments

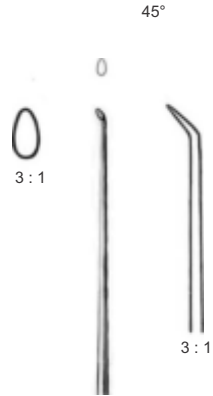

SHEA  
TS.12.210.35  
1.5 X 1 mm

Knife for anterior crurotomy

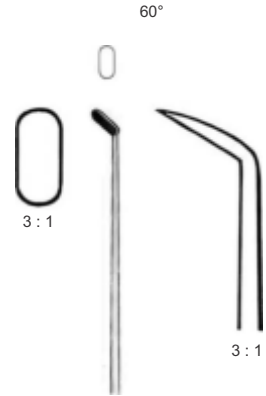

TS.12.210.38  
4.0 X 2.5 mm

Knife for incising skin of external

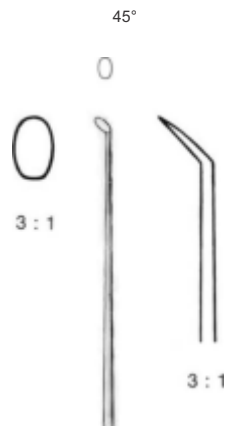

HARRISON  
TS.12.210.39

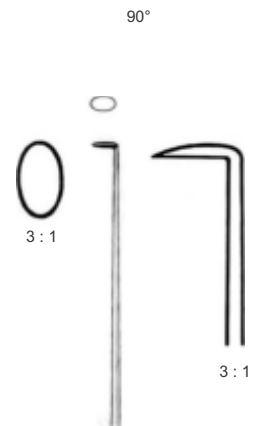

HARRISON  
TS.12.210.47

Knife for the tympanic membrane

# Otology Instruments

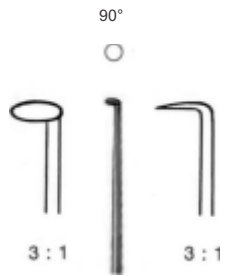

AUSTIN  
TS.12.211.22  
Ø 2.0 mm



GERLACH  
TS.12.211.25  
Ø 3.0 mm



Round knife for incising skin



# Otology Instruments

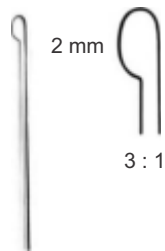

GUILFORD-WRIGHT  
TS.12.212.03

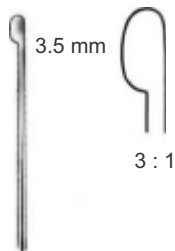

PLESTER  
TS.12.212.05

Flap knife



TS.12.212.17  
2.5 mm

Incision Knife



AUSTIN  
TS.12.212.32  
3.0 X 1.0 mm

Sickle Knife



TS.12.212.35

Discision knife for the footplate

# Otology Instruments

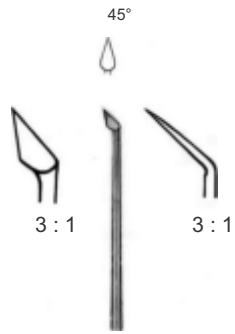

ROSEN  
 TS.12.213.53

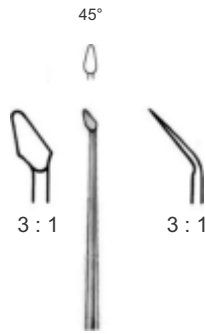

HOUGH  
 TS.12.213.55  
 2.0 x 1 - 2 mm



HOUSE  
 TS.12.213.58  
 2.0 X 1.0 mm

Incision knife

Lancet knife no. 2



SHEA  
 TS.12.213.65  
 2.0 X 1.5 mm

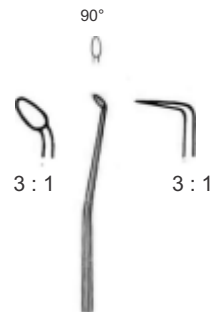

AUSTIN  
 TS.12.213.67  
 1.8 X 1.2 mm

Incision knife

# Otology Instruments

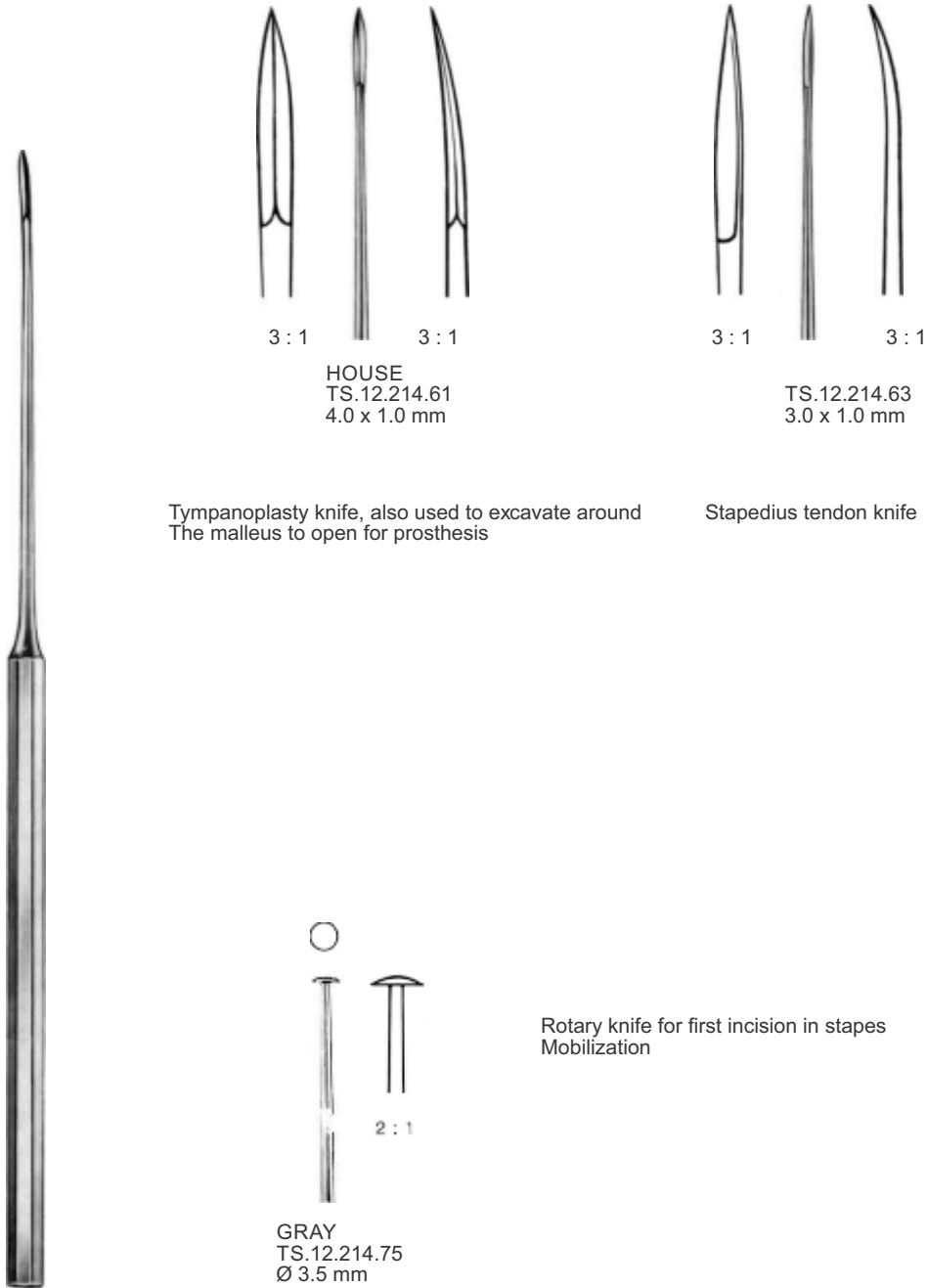

# Otology Instruments



TABB  
TS.12.215.40  
1.5 X 1 - 1.5 mm

Knife for the mucosa and tympanoplasty



SCHUKNECHT  
TS.12.215.46  
5.0 X 1.0 mm

Sickle knife



HOUSE  
TS.12.215.41  
6.0 x 1.5 mm

Sickle knife no.1

# Otology Instruments

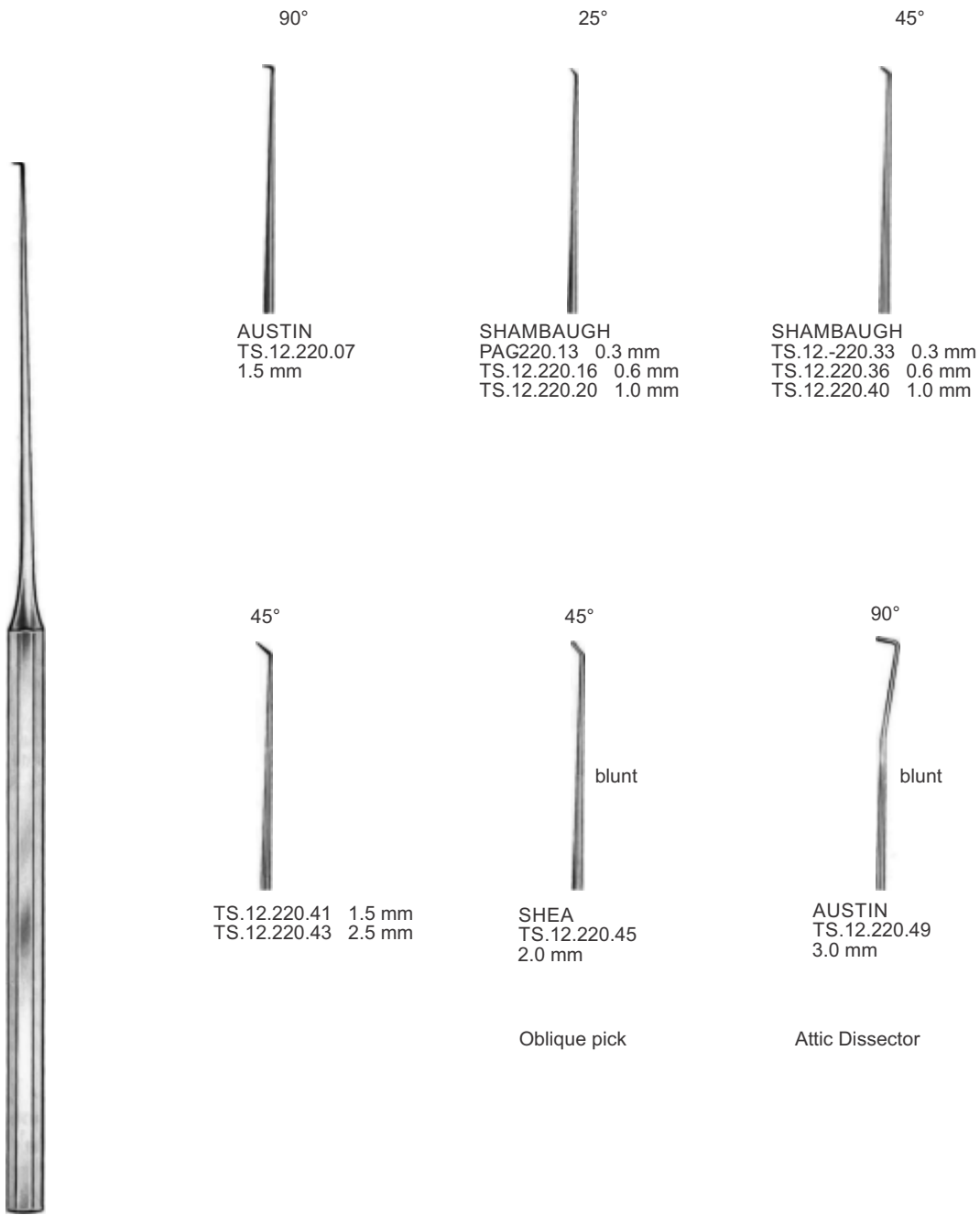



sharp

BARBARA  
TS.12.221.01



sharp

TS.12.221.03



sharp

ROSEN  
TS.12.221.04



blunt

TS.12.221.05



blunt

TS.12.221.06

# Otology Instruments

Angled up

Angled down



25°



TS.12.222.13 0.3 mm  
TS.12.222.14 0.6 mm  
TS.12.222.20 1.0 mm

TS.12.222.23 0.3 mm  
TS.12.222.26 0.6 mm  
TS.12.222.30 1.0 mm



45°



TS.12.222.33 0.3 mm  
TS.12.222.36 0.6 mm  
TS.12.222.40 1.0 mm

TS.12.222.43 0.3 mm  
TS.12.222.46 0.6 mm  
TS.12.222.50 1.0 mm



90°



TS.12.222.53 0.3 mm  
TS.12.222.56 0.6 mm  
TS.12.222.60 1.0 mm

TS.12.222.63 0.3 mm  
TS.12.222.66 0.6 mm  
TS.12.222.70 1.0 mm

# Otology Instruments

90°



SHAMBAUGH  
 PAG223.53 0.3 mm  
 TS.12.223.56 0.6 mm  
 TS.12.223.58 0.8 mm  
 TS.12.223.60 1.0 mm



SHAMBAUGH  
 PAG223.62 1.2 mm  
 TS.12.223.65 1.5 mm  
 TS.12.223.74 2.5 mm



TS.12.223.75 0.5 mm  
 TS.12.223.80 1.0 mm



GOLDMANN  
 TS.12.223.85

Retractor for malleus



PLESTER  
 TS.12.223.90

For roughening the back of the  
 Tympanic membrane



sharp

ROSEN  
 TS.12.223.95

Oval window fenestración



# Otology Instruments

curved up

curved down



MCGEE  
TS.12.225.75 0.5 mm  
TS.12.225.80 1.0 mm



MCGEE  
TS.12.225.85 0.5 mm  
TS.12.225.90 1.0 mm



FISCH  
TS.12.225.92 0.2 mm  
PLESTER  
TS.12.225.96 0.6 mm

Footplate hook

# Otology Instruments

angled right

angled left



ANTOLI-CANDELA  
TS.12.226.72  
0.6 mm



ANTOLI-CANDELA  
TS.12.226.73  
0.6 mm

90°



TS.12.226.92  
1.0 mm



TS.12.226.93  
1.0 mm

90°

# Otology Instruments



AUSTIN  
TS.12.230.22

Raspatory (Round knife),  
Ø 2 mm, angled up 90°



ANTOLI-CANDELA  
TS.12.230.23

Elevator (Raspatory) for  
Dissection of soft tissue,  
1.8 mm wide, curved



ROSEN  
TS.12.230.25



ROSEN  
TS.12.230.31



ROSEN  
TS.12.230.32

# Otology Instruments



GOLDMANN  
 TS.12.231.03

Elevator and dissecting knife for soft  
 Tissues, oval shape, 2.5 mm wide,  
 Light curve



HOUSE  
 TS.12.231.11

Stapes-elevator, blade 12 mm long,  
 1 mm wide, slightly angled up



SHEA  
 TS.12.231.31

Right  
 Direito  
 Droit

1.2 mm



SHEA  
 TS.12.231.32

Left  
 Esquerdo  
 Gauche



1.5 mm

blunt



SHAMBAUGH-DERLACKI  
 TS.12.231.71  
 14 cm/ 5½"

# Otology Instruments



SHAMBAUGH-DERLACKI  
TS.12.232.75  
14.5 cm/ 5¾"

Elevator (Raspatory), 2, 0 mm wide,  
Angled tip



SHAMBAUGH-DERLACKI  
TS.12.232.76  
14.5 cm/ 5¾"

Duckbill Elevator (Raspatory)  
3 mm wide, slightly curved

# Otology Instruments



SCHUKNECHT  
TS.12.233.43

Mucosa Elevator, flat, 1 mm wide,  
tip slightly curved up



HOUGH  
TS.12.233.50



HOUGH  
TS.12.233.51

Excavator for oval window, heavy pattern

# Otology Instruments

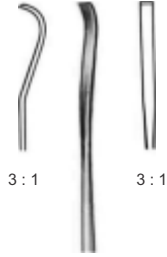

ROSEN  
TS.12.235.61

Mobilizer, 1.8mm wide



GOLDMANN  
TS.12.235.65

Mobilizer with ball tip, Ø 0.8 mm,  
Angled up 25°



GOLDMANN  
TS.12.235.68

Plugger with ball tip, Ø 1.0 mm,  
For placing implant material

# Otology Instruments



ANTOLI-CANDELA  
 TS.12.236.05

Measuring rod, markers at 4.0 mm, 4.5 mm and 5 mm



HOUGH  
 TS.12.236.10

Measuring rod, markers at 3.5 mm, 4 mm and 4.5 mm



AUSTIN  
 TS.12.236.15

Measuring and introduction probe for incudo  
 Stapedial prostheses, marking at 3.5 4 and 4.5 mm



TS.12.236.33

Wire guide and applicator for prosthesis,  
 V-notch , light curve



# Otology Instruments

Ø 1.0 mm

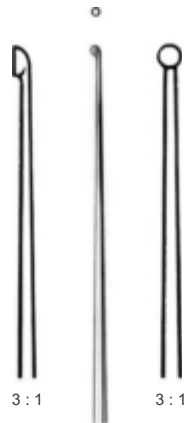

GUILFORD-WRIGHT  
TS.12.238.10

Ø 1.5 mm



GUILFORD-WRIGHT  
TS.12.238.15

2 mm

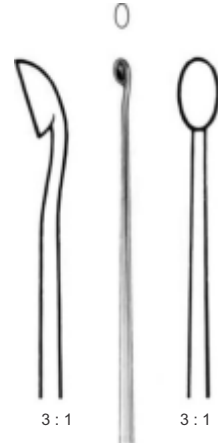

ROSEN  
TS.12.238.27



Curette, for tympanoplasty and myringoplasty

1.3 mm



GUILFORD-WRIGHT  
TS.12.238.31

1.3 mm



GUILFORD-WRIGHT  
TS.12.238.33

Curette, for tympanoplasty and myringoplasty

# Otology Instruments



AUSTIN  
 TS.12.239.40  
 45°, 0.8 X 0.5 mm



HOUSE  
 TS.12.239.41  
 90°, 0.8 mm

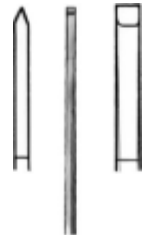

AUSTIN  
 TS.12.239.65  
 1 mm



right

HOUGH  
 TS.12.239.52  
 # 3



left

HOUGH  
 TS.12.239.53  
 # 4



right

AUSTIN  
 TS.12.239.54



left

AUSTIN  
 TS.12.239.55



# Otology Instruments

Ø 1.0 mm

Ø 1.5 mm

Ø 1.0 mm

Ø 1.5 mm



3:1

HOUSE  
TS.12.240.70



3:1

HOUSE  
TS.12.240.75



3:1

HOUSE  
TS.12.240.80



3:1

HOUSE  
TS.12.240.85



Ø 1.2 mm

Double-ended Curette for Stapedectomy,  
Cups slightly angled forwards



Ø 1.8mm



Ø 1.2 mm

Double-ended curette for stapedectomy,  
Cups strongly angled forwards

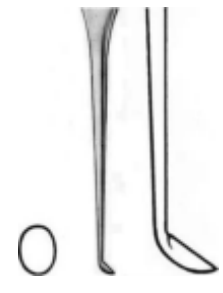

Ø 1.8 mm



# Otology Instruments

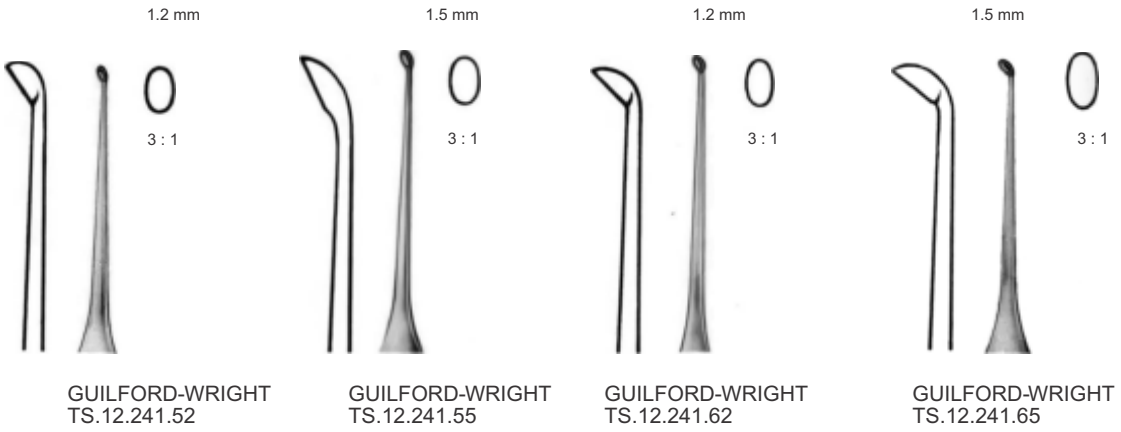

Curette for stapedectomy, cups slightly  
Angled forwards

Curette for stapedectomy, cups strongly  
Angled forwards

# Otology Instruments

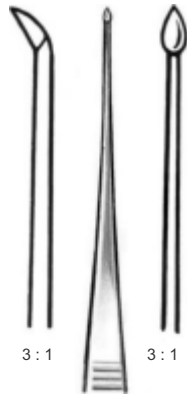

TS.12.242.90  
17 cm/ 6¾"

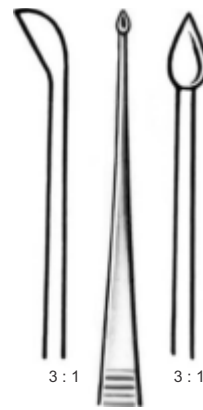

TS.12.242.92  
17 cm/ 6¾"

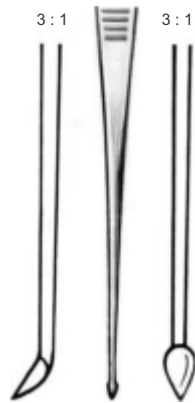

Double-ended curette for  
Stapedectomy, pointed, small

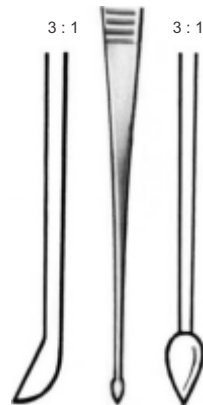

Double-ended curette for  
Stapedectomy, pointed, large



Laryngoscopes

## McIntosh Set, with Fiber Optic illumination With Interchangeable, Fiberoptic Channels

- TS.12.42.00 Set of 3 blades No. 2,3,4
- TS.12.42.02 Set of 5 blades No. 00,0,1,2,3 (pediatric)
- TS.12.42.03 Set of 4 blades No. 0,1,2,3 (pediatric)
- TS.12.43.04 Set of 4 blades No. 1,2,3,4
- TS.12.43.05 Set of 5 blades No. 0,1,2,3,4

All sets include 1 standard F.O. battery handle.  
Spare lamps can be ordered separately.

Supplied in hard plastic case.



## McIntosh Set, with Standard illumination

- TS.12.22.00 Set of 3 blades No. 2,3,4
- TS.12.22.02 Set of 5 blades No. 00, 0,1,2,3 (pediatric)
- TS.12.22.03 Set of 4 blades No. 0,1,2,3 (pediatric)
- TS.12.23.04 Set of 4 blades No. 1,2,3,4
- TS.12.23.05 Set of 5 blades No. 0,1,2,3,4
- TS.12.23.06 Set of 5 blades No. 1,2,3,4,5

All sets include 1 standard battery handle.  
Spare lamps can be ordered separately.

Supplied in hard plastic case.



## McIntosh Set, with Standard illumination Economy Model

- TS.12.22.50 Set of 3 blades No. 2,3,4
- TS.12.23.64 Set of 4 blades No. 1,2,3,4

All sets include 1 standard battery handle.  
Spare lamps can be ordered separately.

Supplied in hard, round artificial leather bag with  
pockets to hold blades.



## McIntosh Set, with Fiber Optic illumination With Integrated, Fiberoptic Channel

- TS.12.42.20 Set of 3 blades No. 2,3,4
- TS.12.42.23 Set of 4 blades No. 0,1,2,3 (pediatric)
- TS.12.43.24 Set of 4 blades No. 1,2,3,4
- TS.12.43.25 Set of 5 blades No. 0,1,2,3,4

All sets include 1 standard F.O. battery handle.  
Spare lamps can be ordered separately.

Supplied in hard plastic case.



## McIntosh Set, with Fiber Optic illumination With Intechangeable, Fiberoptic Channel

Set with new type of battery handle with double barrell  
(inside) for better autoclaving & safety to the bulb.

- TS.12.42.50 Set of 3 blades No. 2,3,4
- TS.12.43.94 Set of 4 blades No. 1,2,3,4

All sets include 1 standard F.O. battery handle.  
Spare lamps can be ordered separately.

Supplied in hard plastic case.





## Miller Set, with Standard Illumination

- TS.12.28.00 Set of 3 blades No. 1,2,3
- TS.12.28.03 Set of 5 blades No. 00,0,1,2,3 (pediatric)
- TS.12.28.04 Set of 4 blades No. 0,1,2,3 (pediatric)
- TS.12.28.05 Set of 4 blades No. 1,2,3,4
- TS.12.28.06 Set of 5 blades No. 0,1,2,3,4

All sets include 1 standard battery handle.  
Spare lamps can be ordered separately.

Supplied in hard plastic case.



## Miller Set, with Fiber Optic Illumination With Interchangeable, Fiberoptic Channels

- TS.12.48.00 Set of 3 blades No. 1,2,3
- TS.12.48.03 Set of 5 blades No. 00,0,1,2,3 (pediatric)
- TS.12.48.04 Set of 4 blades No. 0,1,2,3 (pediatric)
- TS.12.48.05 Set of 4 blades No. 1,2,3,4
- TS.12.48.06 Set of 5 blades No. 1,2,3,4,5

All sets include 1 F.O. battery handle.  
Spare lamps can be ordered separately.

Supplied in hard plastic case.



## Wis-Foregger Set, with Standard Illumination

- TS.12.26.00 Set of 3 blades No. 2,3,4
- TS.12.26.03 Set of 5 blades No. 00,0,1,2,3 (pediatric)
- TS.12.26.04 Set of 4 blades No. 0,1,2,3 (pediatric)
- TS.12.26.05 Set of 4 blades No. 1,2,3,4
- TS.12.26.06 Set of 5 blades No. 0,1,2,3,4

All sets include 1 standard battery handle.  
Spare lamps can be ordered separately.

Supplied in hard plastic case.



## Wis-Foregger Set, with Fiber Optic Illumination With Interchangeable, Fiberoptic Channels

- TS.12.46.00 Set of 3 blades No. 2,3,4
- TS.12.46.04 Set of 4 blades No. 0,1,2,3 (pediatric)
- Set of 4 blades No. 1,2,3,4
- TS.12.46.06 Set of 5 blades No. 0,1,2,3,4

All sets include 1 F.O. battery handle.  
Spare lamps can be ordered separately.

Supplied in hard plastic case.



## Wis-Foregger Set, with Fiber Optic Illumination With Interchangeable, Fiberoptic Channels

Set with new type of Battery handle with double  
barrell (inside) for better autoclaving and safety to  
the bulb.

- TS.12.46.90 Set of 3 blades No. 2,3,4
- TS.12.46.94 Set of 4 blades No. 1,2,3,4

Supplied in hard plastic case.



# Otology Instruments

## McIntosh Blades, with Standard Illumination

Item No	Fig	Size	For
TS.12.24.09	00	45 mm	Premature babies
TS.12.24.10	0	55 mm	Premature babies
TS.12.24.11	1	70 mm	Infants
TS.12.24.12	2	90 mm	Children
TS.12.24.13	3	110 mm	Adults, Medium
TS.12.24.14	4	130 mm	Adults, Large
TS.12.24.15	5	155 mm	Adults, Extra Large

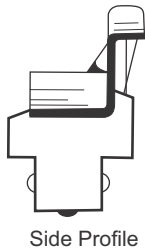

Side Profile

- Smooth Shape
- Bright Light
- Secure connections
- Matt Finish
- Standard Specifications



TS.12.24.11



TS.12.24.12



TS.12.24.13



TS.12.24.14



TS.12.24.15



TS.12.24.09



TS.12.24.10

# Otology Instruments

McIntosh Blades, with Fiber Optic Illumination  
Interchangeable Fiber Optic Channels.

Item No	Fig	Size	For
TS.12.44.09	00	45 mm	Premature babies
TS.12.44.10	0	55 mm	Premature babies
TS.12.44.11	1	70 mm	Infants
TS.12.44.12	2	90 mm	Children
TS.12.44.13	3	110 mm	Adults, Medium
TS.12.44.14	4	130 mm	Adults, Large
TS.12.44.15	5	155 mm	Adults, Extra Large

Fiberoptic channels can be taken apart by simple unscrewing. They can be ordered separately.

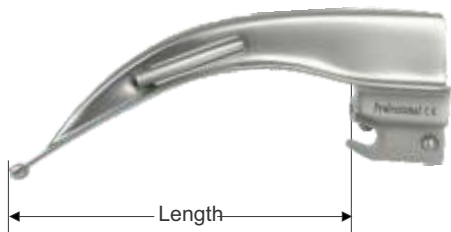

- Replaceable F.O. Channels
- Big Fiber Optic bundle.
- Both ends well protected
- Smooth Shape
- Bright Light
- Secure connections
- Matt Finish
- Standard Specifications



# Otology Instruments

McIntosh Blades, with Fiber Optic Illumination  
Integrated Fiber Optic Channels.

Item No	Fig	Size	For
TS.12.44.21	1	70 mm	Infants
TS.12.44.22	2	90 mm	Children
TS.12.44.23	3	110 mm	Adults, Medium
TS.12.44.24	4	130 mm	Adults, Large

Fiber Optic Channels are completely integrated into the body of blades.



TS.12.44.21



TS.12.44.23

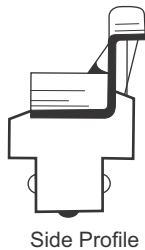

TS.12.44.23



TS.12.44.24

- Completely Sealed Design
- Big Fiber Optic bundle.
- Both ends well protected
- Smooth Shape
- Bright Light
- Secure connections
- Matt Finish
- Standard Specifications

## Wis-Foregger Blades, with Standard Illumination

Item No	Fig	Size	For
TS.12.26.10	0	55 mm	Premature babies.
TS.12.26.11	1	70 mm	Infants
TS.12.26.12	2	90 mm	Children
TS.12.26.13	3	110 mm	Adults, Medium
TS.12.26.14	4	135 mm	Adults, Large



- Smooth Shape
- Bright Light
- Secure connections
- Matt Finish
- Standard Specifications



## Wis-Foregger Blades, with Fiber Optic Illumination Interchangeable, Fiber Optic Channel

Item No	Fig	Size	For
TS.13.46.09	00	45 mm	Premature babies
TS.13.46.10	0	55 mm	Premature babies
TS.13.46.11	1	70 mm	Infants
TS.13.46.12	2	90 mm	Children
TS.13.46.13	3	110 mm	Adults, Medium
TS.13.46.14	4	135 mm	Adults, Large

Fiberoptic channels can be taken apart by simple unscrewing. They can be ordered separately.

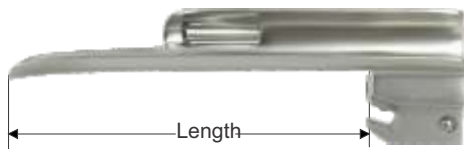

TS.13.46.09



TS.13.46.10



TS.13.46.11



TS.13.46.12



TS.13.46.13



TS.13.46.14

- Replaceable F.O. Channels
- Big Fiber Optic bundle.
- Both ends well protected
- Smooth Shape
- Bright Light
- Secure connections
- Matt Finish
- Standard Specifications

## Miller Blades, with Standard Illumination

Item No	Fig	Size	For
TS.13.28.29	00	45 mm	Premature babies.
TS.13.28.30	0	55 mm	Infants
TS.13.28.31	1	80 mm	Children
TS.13.28.32	2	130 mm	Adults, Medium
TS.13.28.33	3	170 mm	Adults, Large
TS.13.28.34	4	180 mm	Adults, Extra Large



TS.13.28.29



TS.13.28.30



TS.13.28.31



Side Profile



TS.13.28.32

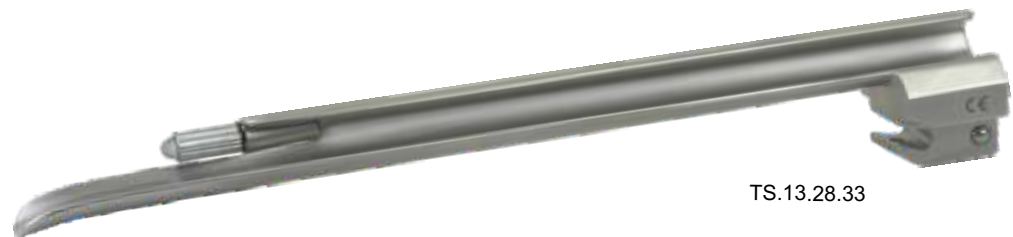

TS.13.28.33



TS.13.28.34

- Smooth Shape
- Bright Light
- Secure connections
- Matt Finish
- Standard Specifications



# Otology Instruments

## Miller Blades, with Fiber Optic Illumination Interchangeable, Fiber Optic Channel

Item No	Fig	Size	For
TS.13.48.29	00	45 mm	Premature babies.
TS.13.48.30	0	55 mm	Infants
TS.13.48.31	1	80 mm	Children
TS.13.48.32	2	130 mm	Adults, Medium
TS.13.48.33	3	170 mm	Adults, Large
TS.13.48.34	4	180 mm	Adults, Extra Large

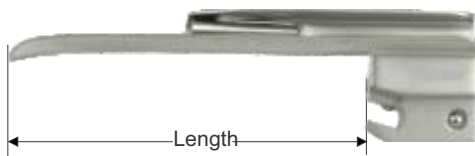

TS.13.48.29



TS.13.48.30



TS.13.48.31



TS.13.48.32



TS.13.48.33



TS.13.48.34

- Replaceable F.O. Channels
- Big Fiber Optic bundle.
- Both ends well protected
- Smooth Shape
- Bright Light
- Secure connections
- Matt Finish
- Standard Specifications

McIntosh Blades, with Standard Illumination, **Economy Model**

Item No	Fig	Size	For
TS.13.25.11	1	70 mm	Infants
TS.13.25.12	2	90 mm	Children
TS.13.25.13	3	110 mm	Adults, Medium
TS.13.25.14	4	130 mm	Adults, Large



TS.13.25.11



TS.13.25.12

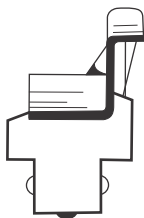

Side Profile



TS.13.25.13

- Smooth Shape
- Bright Light
- Secure connections
- Matt Finish
- Standard Specifications



TS.13.25.14

# Otology Instruments

## Miller Blades, with Standard Illumination, Economy Model

Item No	Fig	Size	For
TS.13.29.31	1	80 mm	Children
TS.13.29.32	2	130 mm	Adults, Medium
TS.13.29.33	3	170 mm	Adults, Large
TS.13.29.34	4	180 mm	Adults, Extra Large

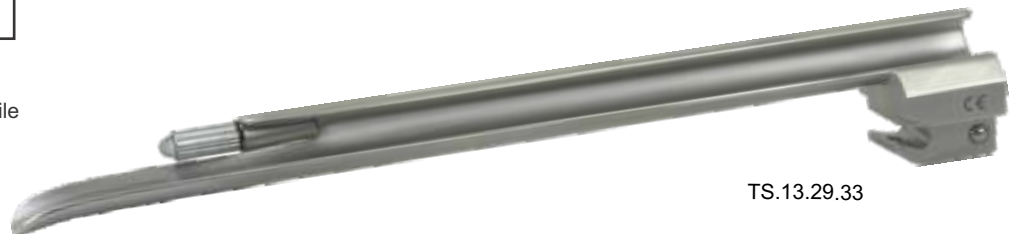
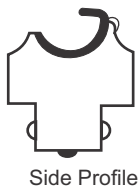

- Smooth Shape
- Bright Light
- Secure connections
- Matt Finish
- Standard Specifications



**Fimz TeleTip**  
Laryngoscope For Difficult Intubation

Item No	Fig	Size	For
TS.13.49.62	2	100 mm	Infants
TS.13.49.63	3	130 mm	Children
TS.13.49.64	4	155 mm	Adults, Medium



Fimz TeleTip is a MacIntosh Laryngoscope blade with an adjustable distal tip, which is controlled by a lever to lift epiglottis during intubation.

It gives a clear view of vocal chords. Un-necessary pressure on tongue and contact with upper teeth is thus avoided.

- Completely autoclavable
- High quality steel construction
- Supplied in hard or soft case.

Battery handles, Fiber Optic  
For blades with Fiberoptic Illumination

Item No	Dia	Size	For
TS.13.30.40	24mm	11cm	
TS.13.31.20	19mm	13cm	Children
TS.13.32.62	28mm	14cm	Adults



TS.13.30.40



TS.13.32.62



TS.13.31.20

Battery Handles, Fiber Optic  
Double Barrel (inside) for better  
cleaning and safety to lamp

Item No	Dia	Size	For
TS.13.35.50	28 mm	14 cm	



TS.13.35.50

**Battery Handles, with Standard Illumination**

Item No	Dia	Size	For
TS.13.30.10	24mm	11cm	Children
TS.13.31.11	19mm	13cm	Pediatric intubation
TS.13.32.12	28mm	14cm	Adults.
TS.13.32.20	28mm	14cm	Adults. (Economy)



TS.13.30.10

TS.13.31.11

TS.13.32.12

TS.13.32.20

# Otology Instruments



COLLIN  
TS.13.16.16  
16 cm / 6¼"

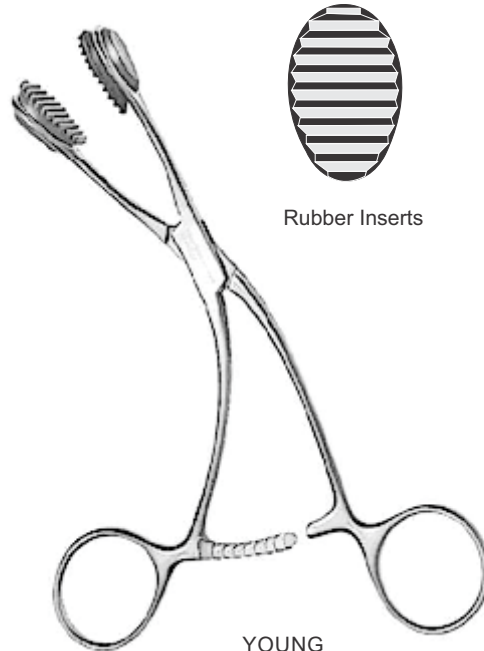

YOUNG  
TS.13.17.16  
16 cm / 6¼"



TS.13.05.16  
16 cm / 6¼"  
Fig # 1



TS.13.05.19  
19 cm / 7½"  
Fig # 2

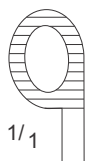

1/1  
TS.13.05.24  
24 cm / 9½"  
Fig # 3

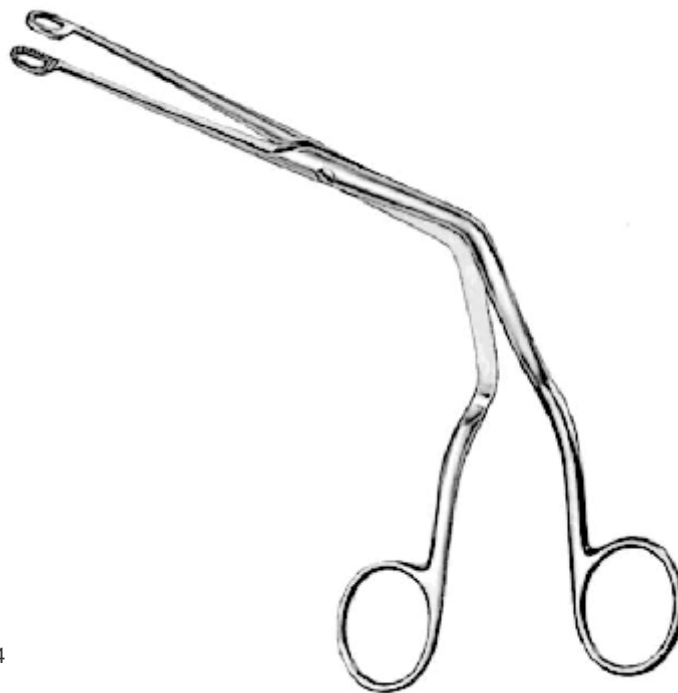

MAGILL

# Otology Instruments



TS.13.03.03  
 (Frame)



DAVIS BOYLE  
 TS.13.02.02  
 Complete  
 (1 Frame, 5 Tongue Depressors)

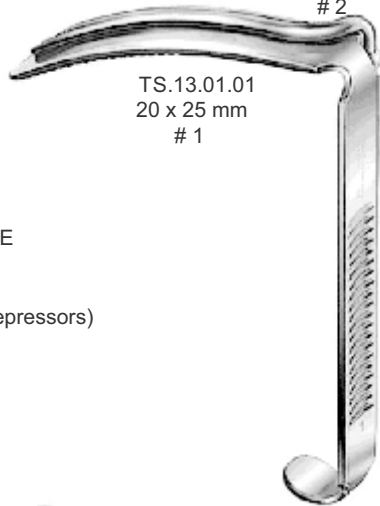

TS.13.01.01  
 20 x 25 mm  
 # 1

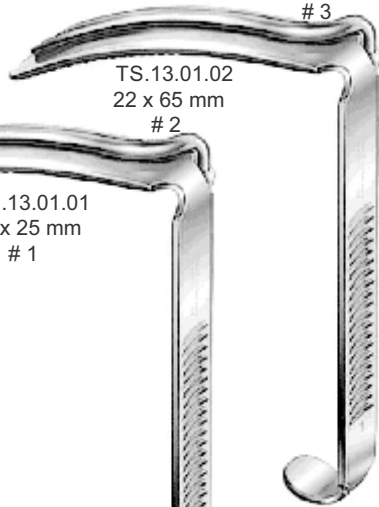

TS.13.01.02  
 22 x 65 mm  
 # 2

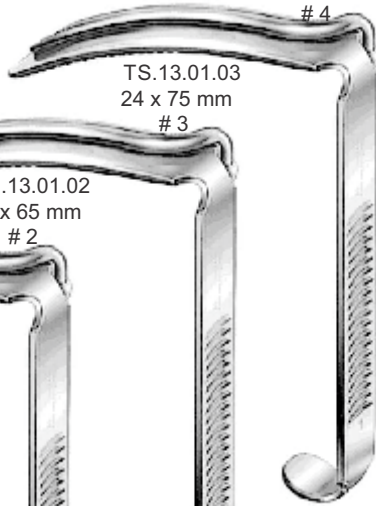

TS.13.01.03  
 24 x 75 mm  
 # 3

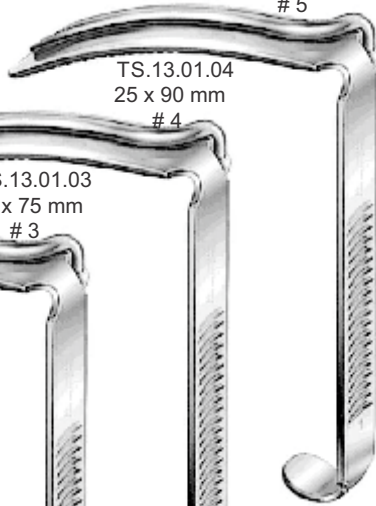

TS.13.01.04  
 25 x 90 mm  
 # 4

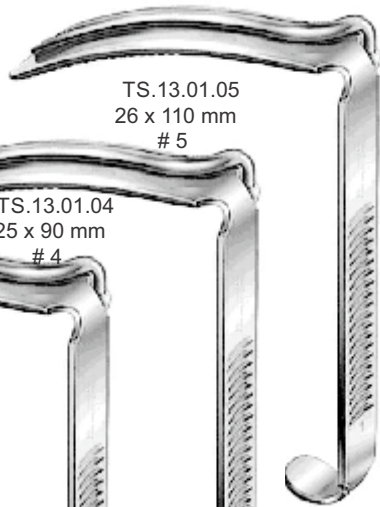

TS.13.01.05  
 26 x 110 mm  
 # 5

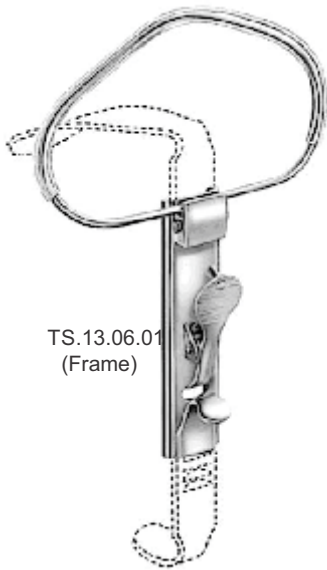

TS.13.06.01  
 (Frame)

MCIVOR  
 TS.13.07.00  
 Complete  
 (1 Frame, 3 Tongue Depressors)

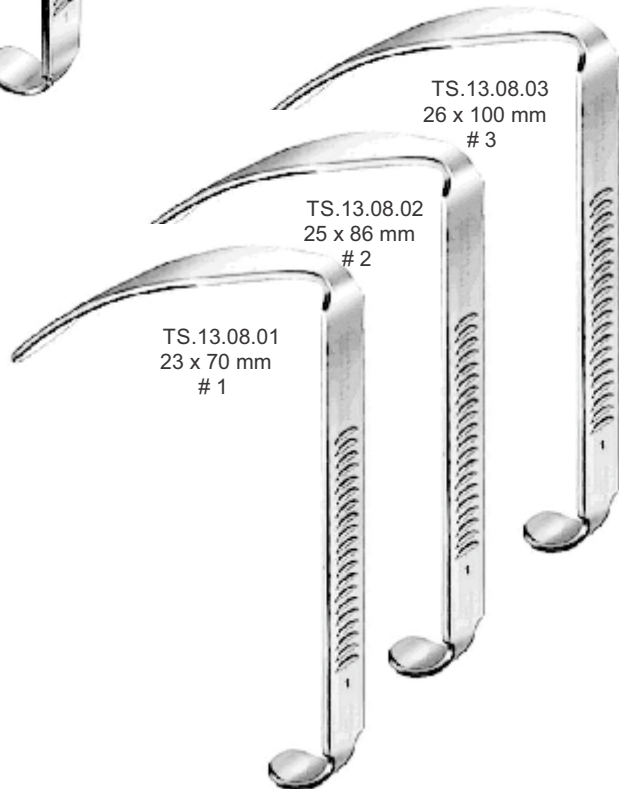

TS.13.08.01  
 23 x 70 mm  
 # 1

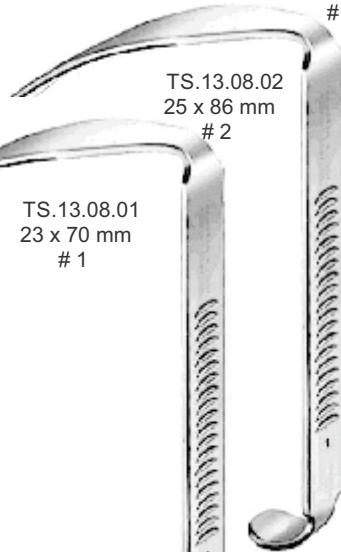

TS.13.08.02  
 25 x 86 mm  
 # 2

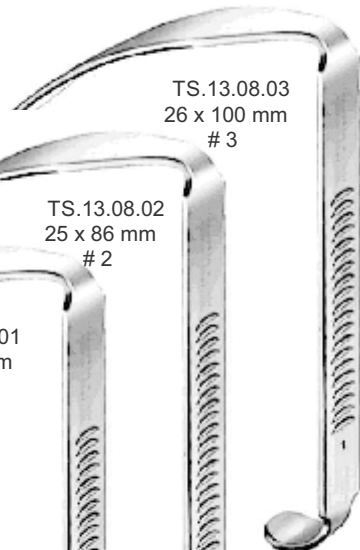

TS.13.08.03  
 26 x 100 mm  
 # 3





Dermatology

Fing Ring Cutters, Comedo Extractors

TS.13.03.01  
Spare Saw  
Blade Only



TS.13.03.00  
16 cm / 6 1/4"

TS.13.05.01  
Spare Saw  
Blade Only



TS.13.04.00  
16 cm / 6 1/4"



SAALFELD  
TS.13.06.11  
11 cm / 4 1/2"



SAALFELD  
TS.13.07.85  
15 cm / 6"



UNNA  
TS.13.08.14  
14 cm / 5 1/2"



UNNA  
TS.13.09.14  
14 cm / 5 1/2"

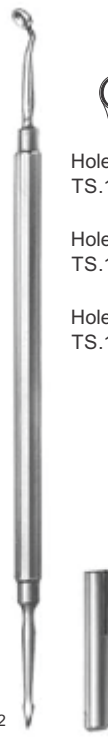

UNNA  
TS.13.08.31 – TS.13.08.42

Hole ø 1 mm  
TS.13.08.31

Hole ø 1.5 mm  
TS.13.08.34

Hole ø 2 mm  
TS.13.08.42



UNNA VIDAL  
TS.13.10.52

## Skin punches, Hooklets, Curettes, Nail Pulling Forceps

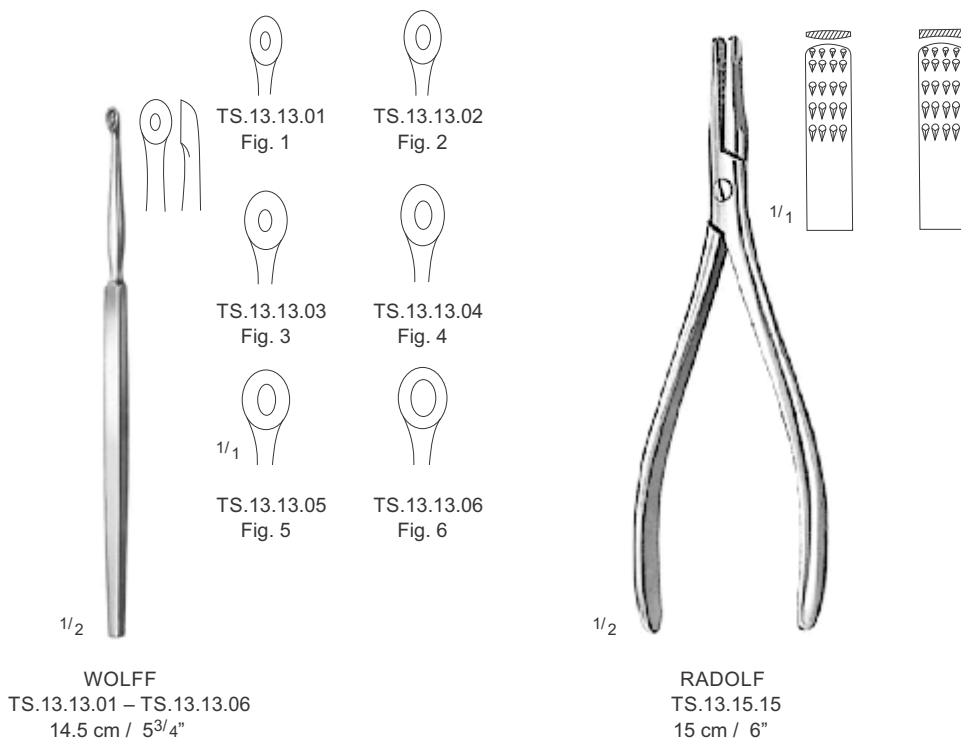
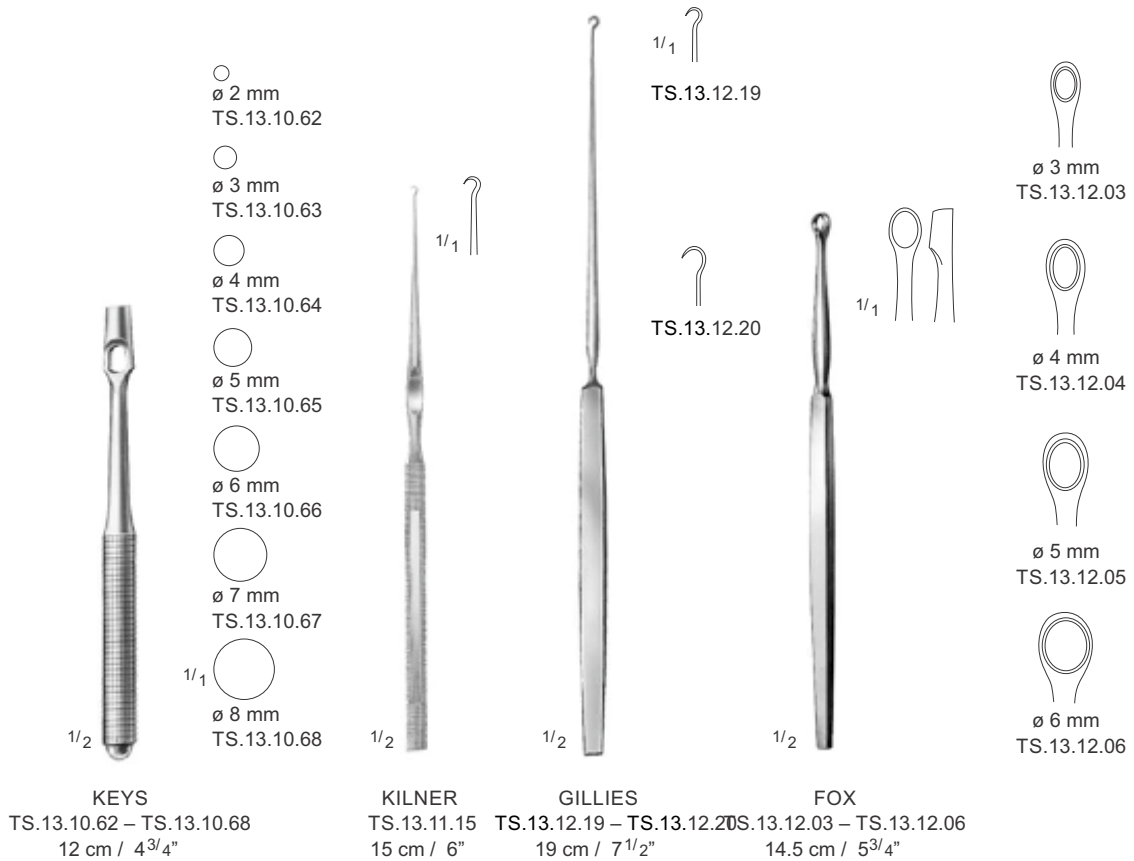



Holloware Instruments

# Holloware Instruments



Horizontal Ventilation

**SCHIMMELBUSCH**

	∅	h
TS.13.25.1414	x 14 cm	
TS.13.25.1616	x 15 cm	
TS.13.25.1919	x 16 cm	
TS.13.25.2019	x 19 cm	
TS.13.25.2424	x 12 cm	
TS.13.25.2524	x 16 cm	
TS.13.25.2724	x 24 cm	
TS.13.25.2929	x 16 cm	
TS.13.25.3029	x 24 cm	
TS.13.25.3434	x 16 cm	
TS.13.25.3534	x 24 cm	
TS.13.25.3939	x 14 cm	
TS.13.25.4039	x 19 cm	
TS.13.25.4139	x 29 cm	



Vertical Ventilation

**KONRICH**

	∅	h
TS.13.26.1414	x 14 cm	
TS.13.26.1616	x 15 cm	
TS.13.26.1919	x 16 cm	
TS.13.26.2019	x 19 cm	
TS.13.26.2424	x 12 cm	
TS.13.26.2524	x 16 cm	
TS.13.26.2724	x 24 cm	
TS.13.26.2929	x 16 cm	
TS.13.26.3029	x 24 cm	
TS.13.26.3434	x 16 cm	
TS.13.26.3534	x 24 cm	
TS.13.26.3939	x 14 cm	
TS.13.26.4039	x 19 cm	
TS.13.26.4139	x 29 cm	



Cather and Instruments Trays (with strap handle)

	L	W	D
TS.13.01.38	217	x 80	x 38 mm
TS.13.01.50	360	x 80	x 50 mm
TS.13.01.51	445	x 120	x 50 mm



with flat cover

	L	W	D
TS.13.02.50	313	x 203	x 50 mm

# Holloware Instruments



Without cover

	L	W	D
TS.13.03.50	227	130	50 mm
TS.13.03.51	306	194	50 mm

	L	W	D
TS.13.04.15	150	100	25 mm
TS.13.04.20	200	150	38 mm
TS.13.04.25	250	200	50 mm
TS.13.04.30	300	250	50 mm
TS.13.04.35	355	305	50 mm
TS.13.04.40	405	305	50 mm
TS.13.04.45	455	355	50 mm



	L	W	D
TS.13.05.21	210	160	10 mm
TS.13.05.24	240	180	10 mm
TS.13.05.31	310	150	10 mm
TS.13.05.32	310	210	10 mm
TS.13.05.35	350	240	10 mm
TS.13.05.40	400	270	10 mm
TS.13.05.42	420	280	10 mm



TS.13.05.82  
ø 200 x 70 mm



TS.13.05.63  
235 x 190 x 40 mm

L = Length    W = Width    D = Depth    ø = Diameter

# Holloware Instruments



	∅	x	Height
TS.13.08.07	75	x	60 mm
TS.13.08.08	75	x	75 mm
TS.13.08.10	100	x	60 mm
TS.13.08.11	100	x	100 mm
TS.13.08.12	125	x	80 mm
TS.13.08.13	125	x	125 mm
TS.13.08.15	150	x	150 mm

KIDNEY BOWL (With Cover)

	Length	Width	Depth
TS.13.11.17	170	x 100	x 35 mm
TS.13.11.25	250	x 140	x 40 mm
TS.13.11.27	275	x 150	x 45 mm
TS.13.11.30	305	x 140	x 50 mm



	∅	x	D	Capacity
TS.13.12.07	165	x	60 mm	0.75 L
TS.13.12.10	175	x	70 mm	1.0 L
TS.13.12.20	220	x	80 mm	2.0 L
TS.13.12.25	225	x	90 mm	2.5 L
TS.13.12.30	240	x	110 mm	3.0 L
TS.13.12.45	275	x	115 mm	4.5 L
TS.13.12.60	290	x	125 mm	6.0 L
TS.13.12.61	310	x	120 mm	6.0 L
TS.13.12.85	345	x	125 mm	8.5 L
TS.13.12.91	380	x	125 mm	11 L



	L	W	D
TS.13.10.17	170	x 100	x 35 mm
TS.13.10.20	200	x 120	x 35 mm
TS.13.10.25	250	x 140	x 40 mm
TS.13.10.27	275	x 150	x 45 mm
TS.13.10.30	305	x 140	x 50 mm



	∅	x	D	Capacity
TS.13.13.16	167	x	62 mm	0.9 L
TS.13.13.20	200	x	75 mm	1.4 L
TS.13.13.23	230	x	82 mm	2.2 L
TS.13.13.26	261	x	94 mm	3.0 L
TS.13.13.29	292	x	103 mm	4.0 L
TS.13.13.32	328	x	111 mm	5.7 L

Sponge Bowls  
(Straight Sided Wall)

	Diameter	Depth	Capacity
TS.13.14.04	108 x 50 mm	0.4 liter	
TS.13.14.06	132 x 58 mm	0.6 liter	
TS.13.14.09	149 x 67 mm	0.9 liter	
TS.13.14.13	169 x 74 mm	1.3 liter	
TS.13.14.18	188 x 75 mm	1.8 liter	



	∅	x	Height
TS.13.15.30	30	x	90 mm
TS.13.15.50	50	x	100 mm
TS.13.15.51	50	x	130 mm
TS.13.15.52	50	x	175 mm
TS.13.15.75	75	x	100 mm
TS.13.15.76	75	x	130 mm
TS.13.15.77	75	x	175 mm
TS.13.15.98	100	x	175 mm
TS.13.15.99	100	x	200 mm



NEEDLE JAR  
Diameter Height Capacity  
TS.13.16.80 80 x 63 mm 0.3 liter



SPUTUM CUP  
With Hinged lid and handle  
Height Diameter  
TS.13.20.80 90 x 80 mm



APPLICATOR JAR WITH COVER  
Height Depth  
TS.13.17.79 79 mm x 185 mm



# Holloware Instruments



TS.13.22.25  
25 cc



TS.13.22.50  
50 cc



TS.13.23.90  
ø 90 x 90 mm, height



TS.13.20.80  
ø 80 x 90 mm

## IODINE CUPS

	Diameter	Depth	Capacity
TS.13.18.52	52	x 34 mm	2 oz
TS.13.18.58	56	x 40 mm	3 oz
TS.13.18.64	64	x 44 mm	4 oz
TS.13.18.71	71	x 45 mm	6 oz
TS.13.18.83	83	x 55 mm	10 oz
TS.13.18.88	88	x 65 mm	14 oz



## WASH BASIN

	Diameter	Depth	Capacity
TS.13.19.80	312	x 80 mm	3.7 liter
TS.13.19.92	336	x 92 mm	4.7 liter



L = Length      W = Width      D = Depth

Style A



	L	W	D
TS.13.21.46	165 x	90 x	35 mm
TS.13.21.50	200 x	100 x	35 mm
TS.13.21.51	200 x	100 x	50 mm
TS.13.21.53	230 x	130 x	50 mm
TS.13.21.56	260 x	150 x	50 mm
TS.13.21.58	280 x	140 x	60 mm
TS.13.21.60	300 x	200 x	50 mm

Style B



	L	W	D
TS.13.23.46	165 x	90 x	35 mm
TS.13.23.50	200 x	100 x	35 mm
TS.13.23.51	200 x	100 x	50 mm
TS.13.23.53	230 x	130 x	50 mm
TS.13.23.55	280 x	140 x	60 mm
TS.13.23.56	260 x	150 x	50 mm
TS.13.23.60	300 x	200 x	50 mm

Style C



	L	W	D
TS.13.22.46	165 x	90 x	35 mm
TS.13.22.48	180 x	80 x	50 mm
TS.13.22.50	200 x	100 x	35 mm
TS.13.22.51	200 x	100 x	50 mm
TS.13.22.53	230 x	130 x	50 mm
TS.13.22.55	250 x	120 x	60 mm
TS.13.22.56	260 x	180 x	50 mm
TS.13.22.58	280 x	140 x	60 mm
TS.13.22.60	300 x	200 x	50 mm
TS.13.22.62	320 x	150 x	60 mm
TS.13.22.66	360 x	160 x	70 mm

# Holloware Instruments

	∅	x	D	Capacity
TS.13.24.10	108	x	131 mm	1.0 L
TS.13.24.19	125	x	188 mm	1.9 L



### Bed Pans

	L	W	H
TS.13.25.10	356 x	289 x	104 mm
TS.13.25.14	311 x	241 x	91 mm



### Fractured Bed Pans

	L	W	H	
TS.13.26.30	302 x	241 x	81 mm	without cover
TS.13.27.30	320 x	241 x	81 mm	with cover



### Urinals

	∅	L	C
TS.13.28.15	113 x	235 x	1.5 L Male Horizontal Type
TS.13.29.17	113 x	220 x	1.7 L Male. Upright Type



### Female Urinals

	L	W	H	Capacity
TS.13.30.11	220 x	115 x	148 mm	1.1 L





Thoracic Instruments

# Thoracic Instruments



1/2  
GLUCK  
TS.13.02.19  
19 cm / 7½"



1/2  
TS.13.03.22  
22 cm / 8¾"

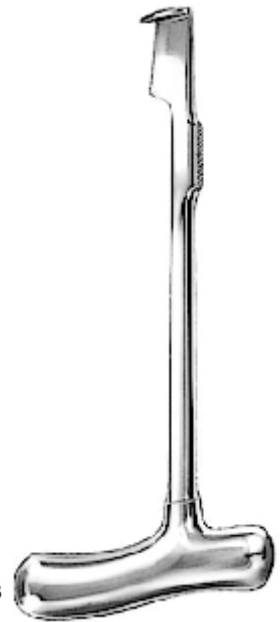

1/3  
LEBSCHE  
TS.13.19.90  
25 cm / 10"

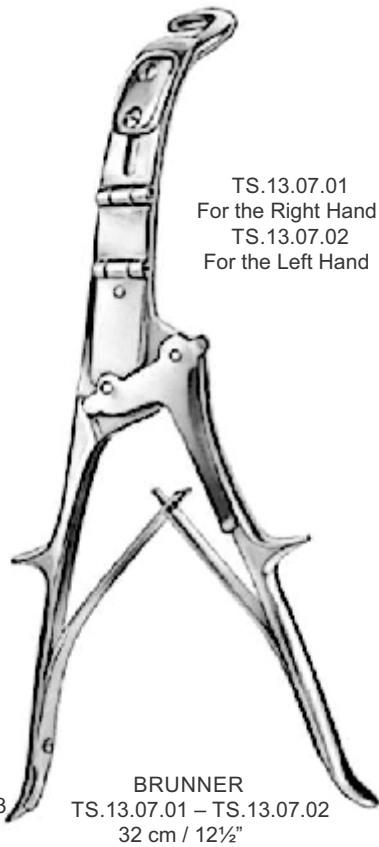

1/3  
BRUNNER  
TS.13.07.01 – TS.13.07.02  
32 cm / 12½"

TS.13.07.01  
For the Right Hand  
TS.13.07.02  
For the Left Hand



1/3  
GIERTZ  
TS.13.14.25  
25 cm / 10"

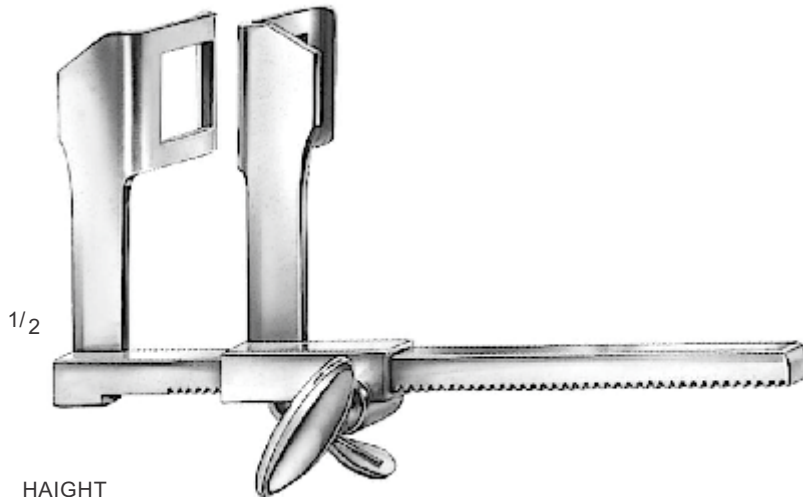

HAIGHT

	a	b	c
TS.13.23.20	30 mm	30 mm	90 m / 3½"

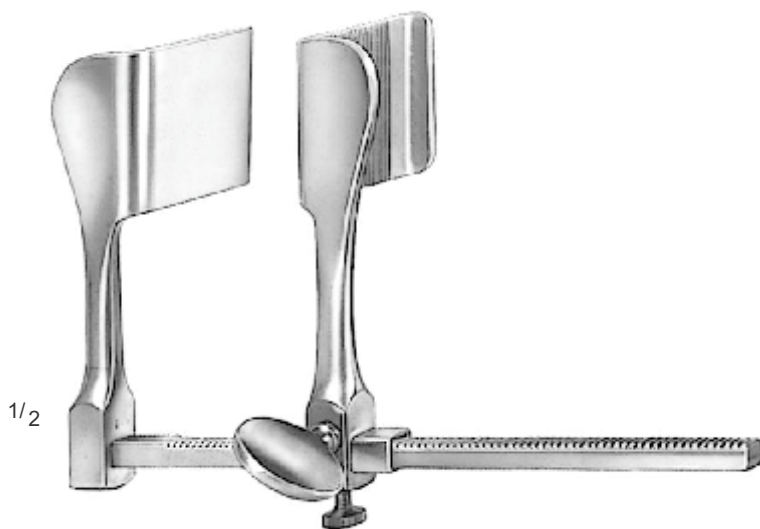
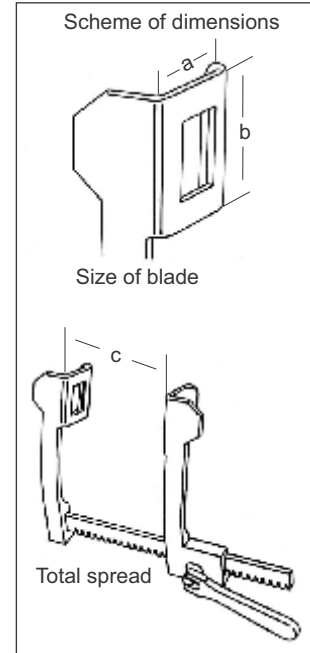

TUFFIER

	a	b	c
TS.13.22.41	45 mm	45 mm	160 mm / 6¼"

# Thoracic Instruments

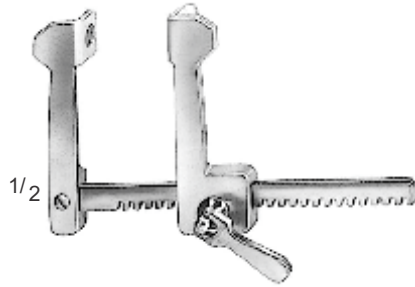

FINOCHIETTO-BABY

	a	b	c
TS.13.21.61	15 mm	15 mm	75 mm / 2"

Scheme of dimensions

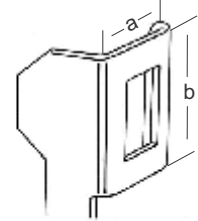

Size of blade

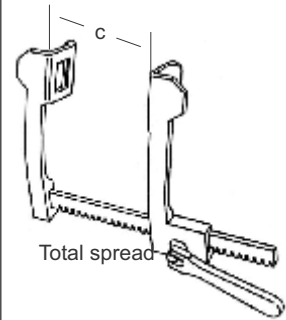

Total spread

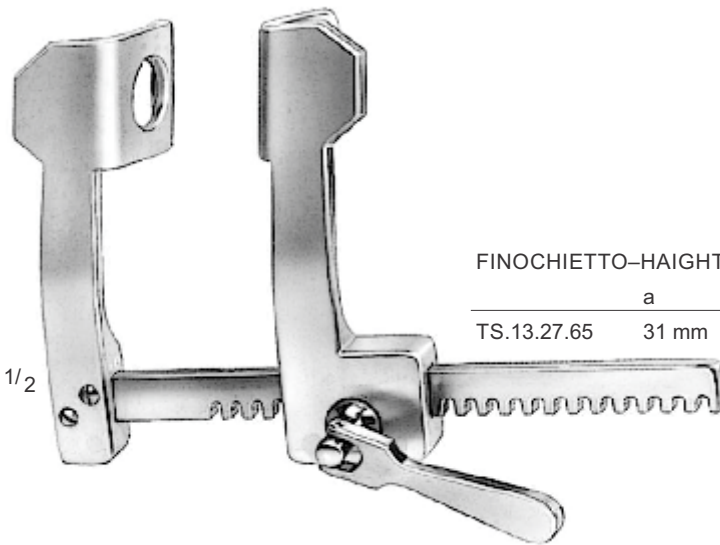

FINOCHIETTO-HAIGHT-BABY

	a	b	c
TS.13.27.65	31 mm	31 mm	100 mm / 4"

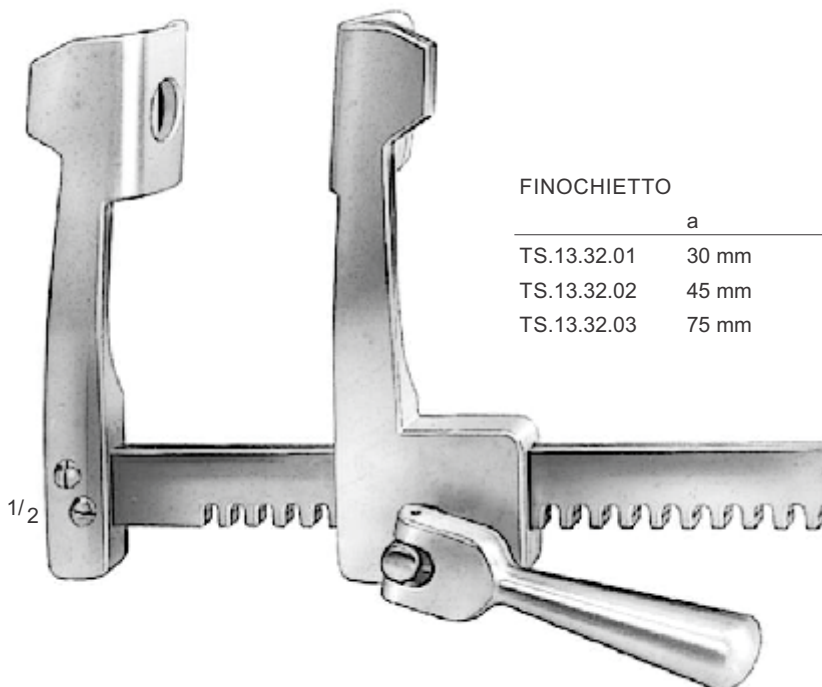

FINOCHIETTO

	a	b	c
TS.13.32.01	30 mm	40 mm	150 mm / 6"
TS.13.32.02	45 mm	65 mm	200 mm / 8"
TS.13.32.03	75 mm	65 mm	250 mm / 10"

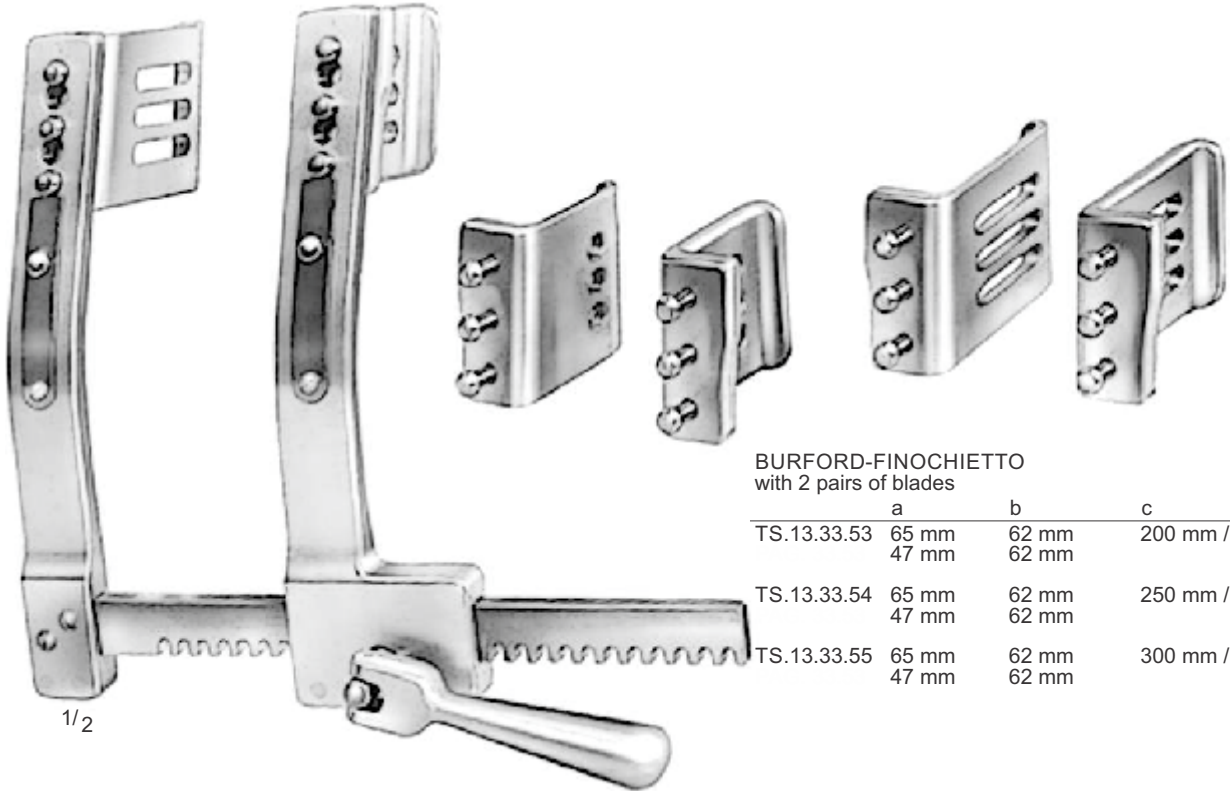

BURFORD-FINOCHIETTO  
with 2 pairs of blades

	a	b	c
TS.13.33.53	65 mm 47 mm	62 mm 62 mm	200 mm / 8"
TS.13.33.54	65 mm 47 mm	62 mm 62 mm	250 mm / 10"
TS.13.33.55	65 mm 47 mm	62 mm 62 mm	300 mm / 12"

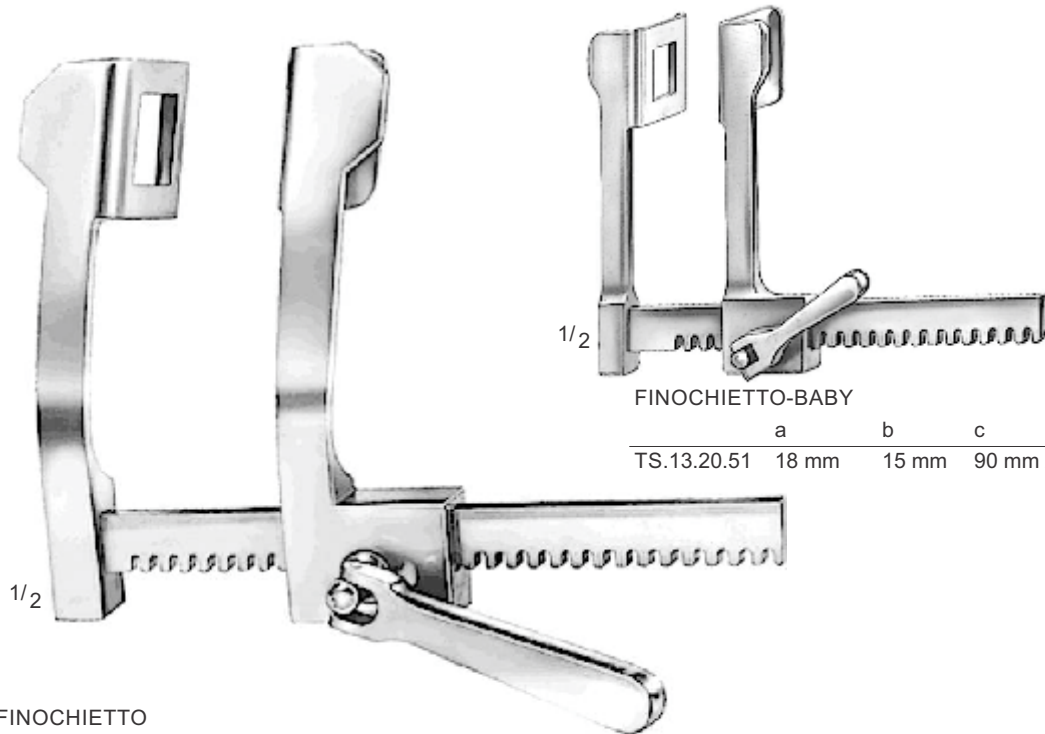

FINOCHIETTO-BABY

	a	b	c
TS.13.20.51	18 mm	15 mm	90 mm / 3½"

FINOCHIETTO

	a	b	c
TS.13.34.01	30 mm	45 mm	150 mm / 6"
TS.13.34.02	46 mm	62 mm	190 mm / 7½"
TS.13.34.03	80 mm	65 mm	190 mm / 7½"

L = Length    W = Width    D = Depth    ø = Diameter



# Thoracic Instruments

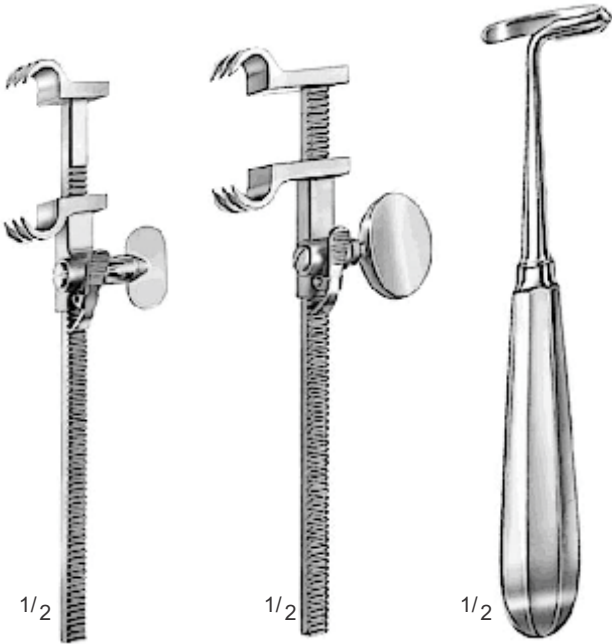

1/2

1/2

1/2

BAILEY  
TS.13.36.40  
16 cm / 6¼"

BAILEY-GIBBON  
TS.13.37.50  
16 cm / 6¼"

DOYEN  
TS.13.45.01 TS.13.46.12  
17 cm / 6¼"

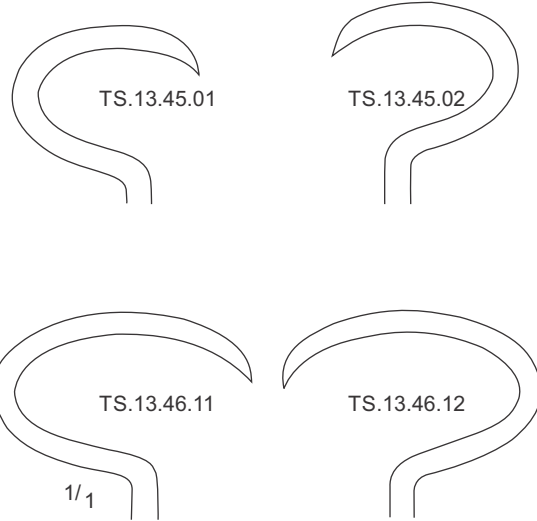

TS.13.45.01

TS.13.45.02

TS.13.46.11

TS.13.46.12

1/1



ALLISON  
TS.13.50.05  
27 cm / 10¼"

TS.13.50.10  
32 cm / 12½"

50 x 75 mm



DAVIDSON  
TS.13.51.50



90 x 75 mm

DAVIDSON  
TS.13.52.90

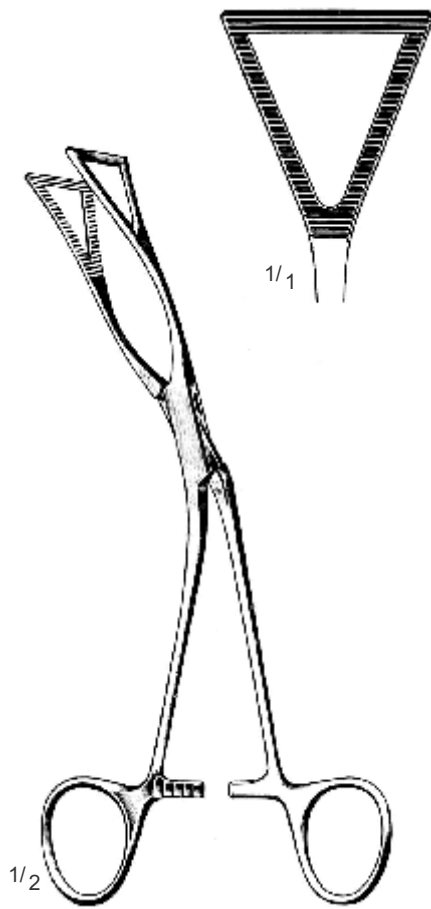

LOVELACE  
TS.13.56.19  
19 cm / 7½"

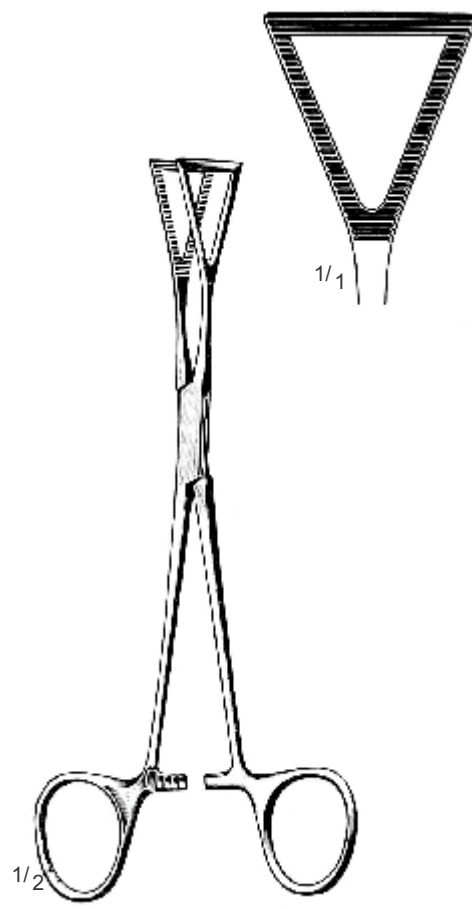

LOVELACE  
TS.13.56.39  
19 cm / 7½"

# Thoracic Instruments

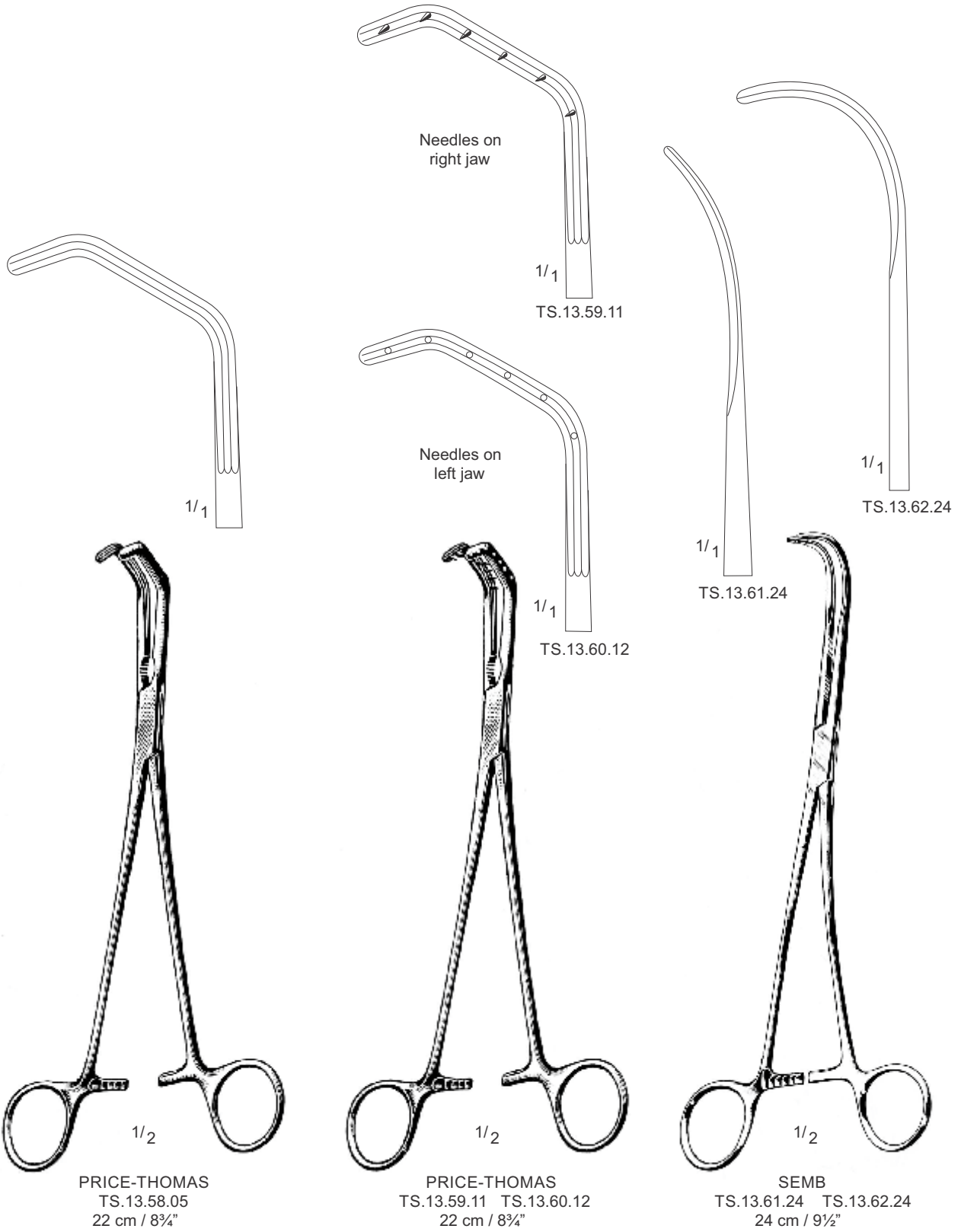

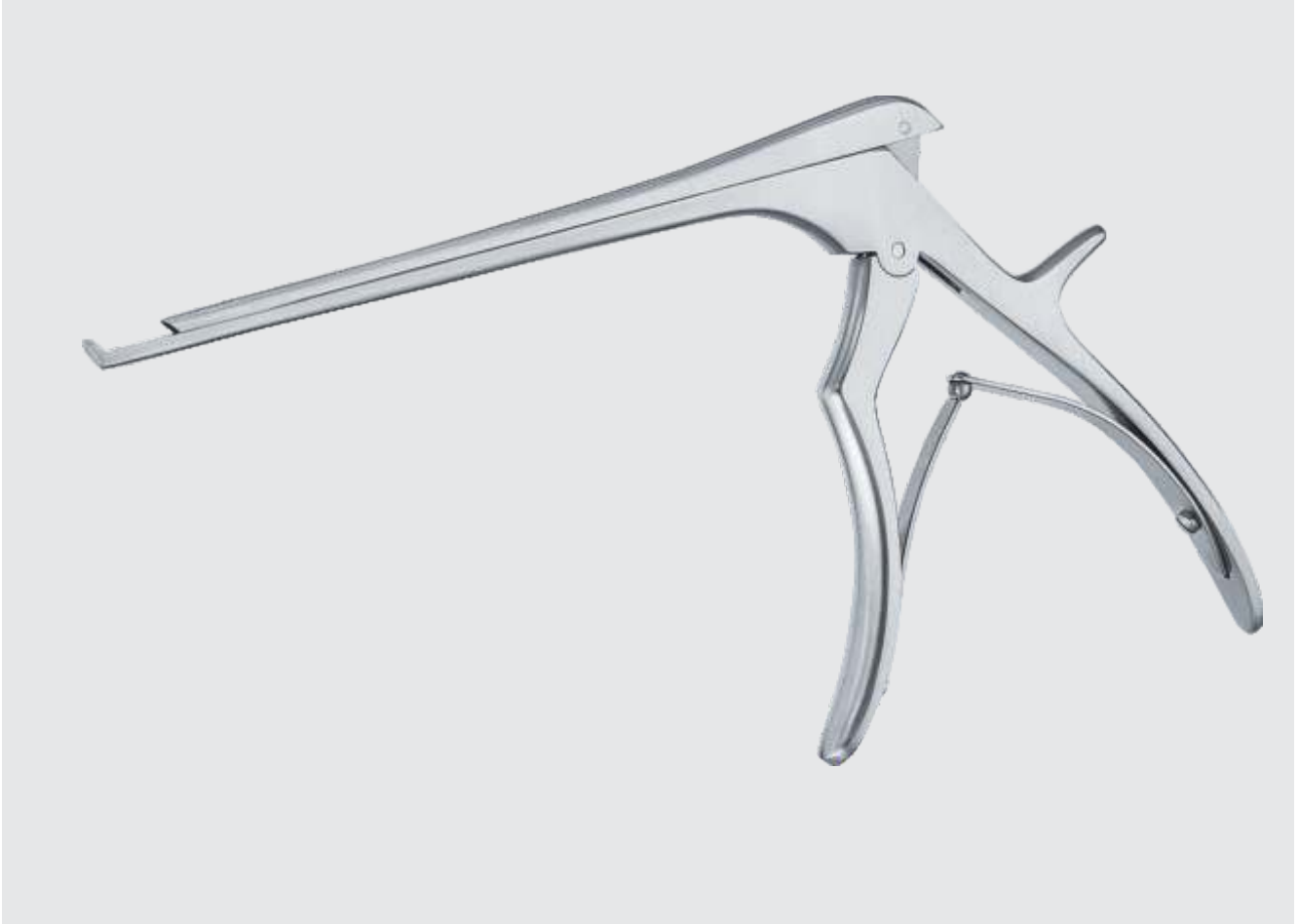

Neurosurgery

# Neurosurgery

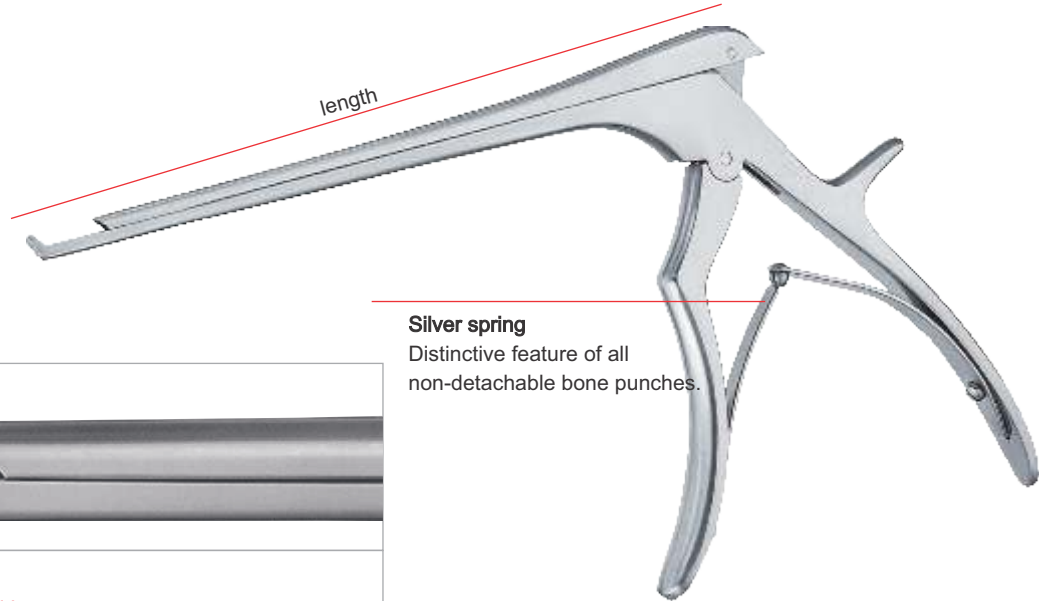

**Silver spring**  
Distinctive feature of all non-detachable bone punches.

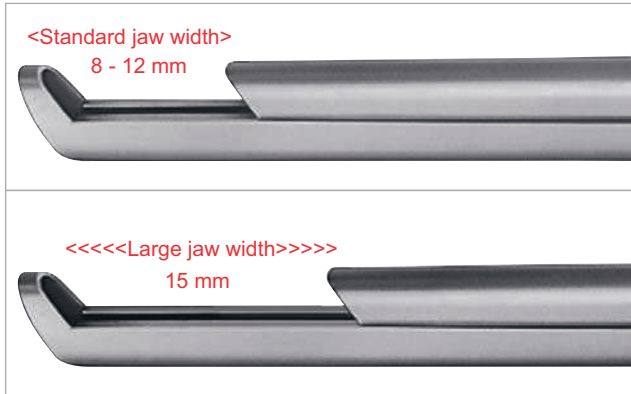







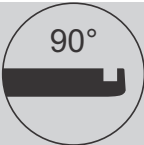
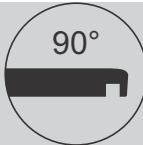
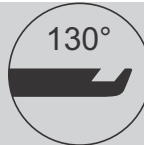
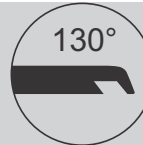

Standard

Lengths - 180 mm









Width (mm)		upward	downward	130° upward	130° downward	Jaw Width
		90°	90°	130°	130°	
1.0	□	TS.13.03.01	TS.13.03.11	TS.13.03.21	TS.13.03.31	8 mm
1.5	□			TS.13.101.03		15 mm
2.0	□	TS.13.03.02	TS.13.03.12	TS.13.03.22	TS.13.03.32	9 mm
				TS.13.101.05		15 mm
2.5	□			TS.13.101.06		10 mm
				TS.13.101.07		15 mm
3.0	□	TS.13.03.03	TS.13.03.13	TS.13.03.23	TS.13.03.33	10 mm
				TS.13.101.09		15 mm
4.0	□	TS.13.03.04	TS.13.03.14	TS.13.03.24	TS.13.03.34	12 mm
				TS.13.101.11		15 mm
5.0	□	TS.13.03.05	TS.13.03.15	TS.13.03.25	TS.13.03.35	12 mm
				TS.13.101.13		15 mm
6.0	□	TS.13.03.06	TS.13.03.16	TS.13.03.26	TS.13.03.36	12 mm
				TS.13.101.15		15 mm

## Standard

### Lengths - 200 mm

Width (mm)	upward	downward	130° upward	130° downward	Jaw Width
					
1.0			-		-
1.5			TS.13.102.02		9 mm
2.0			TS.13.102.04		9 mm
			TS.13.102.05		15 mm
2.5			TS.13.102.06		10 mm
3.0			TS.13.102.08		10 mm
			TS.13.102.09		15 mm
4.0			TS.13.102.10		12 mm
			TS.13.102.11		15 mm
5.0			TS.13.102.12		12 mm
			TS.13.102.13		15 mm
6.0			TS.13.102.14		12 mm
			TS.13.102.15		15 mm

### Lengths - 230 mm

1.0			-	-	-
1.5			-	-	-
2.0			TS.13.103.02	TS.13.103.42	9 mm
2.5			-	-	-
3.0			TS.13.103.08	TS.13.103.48	10 mm
4.0			TS.13.103.10	TS.13.103.50	12 mm
5.0			TS.13.103.12	TS.13.103.52	12 mm
6.0			-	-	-

## Delicate

### Thin footplate

These Kerrison punches feature a distinctive golden distal end.



### Large jaw punches

offer a 65% wider jaw opening compared to standard punches.

### Silver spring

Distinctive feature of all non-detachable bone punches.

<Standard jaw width>  
8 - 12 mm



Thin

### Lengths - 180 mm









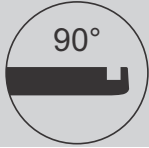

Width (mm)	upward	downward	130° upward	130° downward	Jaw Width
	90°	90°	130°	130°	
1.0	□		TS.13.111.01	TS.13.111.41	8 mm
1.5	□		TS.13.111.02		9 mm
2.0	□		TS.13.111.04	TS.13.111.44	9 mm
2.5	□		TS.13.111.06		10 mm
3.0	□		TS.13.111.08	TS.13.111.48	10 mm
4.0	□		TS.13.111.10	TS.13.111.50	12 mm
5.0	□		TS.13.111.12	TS.13.111.52	12 mm

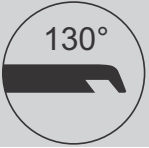
### Lengths - 200 mm

1.0	□		TS.13.112.01		8 mm
1.5	□		TS.13.112.02		9 mm
2.0	□		TS.13.112.04		9 mm
2.5	□		TS.13.112.06		10 mm
3.0	□		TS.13.112.08		10 mm
4.0	□		TS.13.112.10		12 mm
5.0	□		TS.13.112.12		12 mm

## Thin

### Lengths - 230 mm

Width (mm)	upward	downward	130° upward	130° downward	Jaw Width
					
2.0 			TS.13.113.02	TS.13.113.42	9 mm
3.0 			TS.13.113.08	TS.13.113.48	10 mm
4.0 			TS.13.113.10	TS.13.113.50	12 mm
5.0 			TS.13.113.12	TS.13.113.52	12 mm
Lengths - 280 mm					
2.0 			TS.13.114.02		9 mm
3.0 			TS.13.114.08		10 mm
4.0 			TS.13.114.10		12 mm
5.0 			TS.13.114.12		12 mm



## Detachable

- Easy disassembly and assembly
- Efficient cleaning and sterilization
- Nothing can be lost

**for delicate use only** Punches with a thin footplate are used exclusively for removing small portions of bone and soft tissue



## Ejector

for easy removal of punched-out material.

The detachable bone punches are identified by their **golden spring**

## Disassembly in 3 steps:

1. Unhook the spring from the rear handle.



2. Close the handle completely and pull the inner handle downwards.

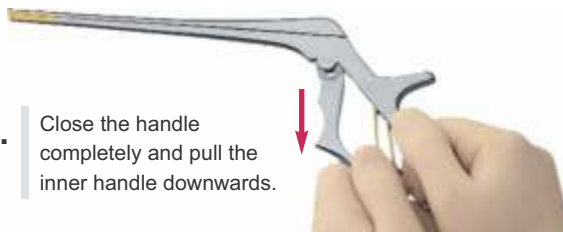

3. Pull back the slider to remove.















**Detachable KERRISON** punches with thin footplate clearly recognizable by the golden distal end.











## Standard

### Lengths - 180 mm

Width (mm)	upward	downward	130° upward	130° downward	Jaw Width	Ejector	
							
1.0		TS.13.03.231	TS.13.03.241	TS.13.101.101	TS.13.101.141	8 mm	
1.5				TS.13.101.102		9 mm	
				TS.13.101.103		15 mm	
2.0		TS.13.03.232	TS.13.03.242	TS.13.101.104	TS.13.101.144	9 mm	
				TS.13.101.105		15 mm	
2.5				TS.13.101.106		10 mm	
				TS.13.101.107		15 mm	
3.0		TS.13.03.233	TS.13.03.243	TS.13.101.108	TS.13.101.148	10 mm	✓
				TS.13.101.109		15 mm	✓
4.0		TS.13.03.234	TS.13.03.244	TS.13.101.110	TS.13.101.150	12 mm	✓
				TS.13.101.111		15 mm	✓
5.0		TS.13.03.235	TS.13.03.245	TS.13.101.112	TS.13.101.152	12 mm	✓
				TS.13.101.113		15 mm	✓
6.0		TS.13.03.236	TS.13.03.246	TS.13.101.114		12 mm	✓
				TS.13.101.115		15 mm	✓







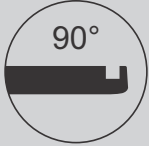
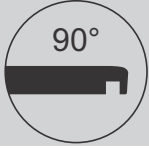
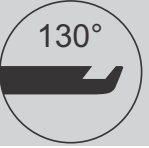
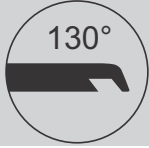

### Lengths - 200 mm

1.0				-		-	
1.5				TS.13.102.102		9 mm	
2.0				TS.13.102.104		9 mm	
				TS.13.102.105		15 mm	
2.5				TS.13.102.106		10 mm	
3.0				TS.13.102.108		10 mm	✓
				TS.13.102.109		15 mm	✓
4.0				TS.13.102.110		12 mm	✓
				TS.13.102.111		15 mm	✓
5.0				TS.13.102.112		12 mm	✓
				TS.13.102.113		15 mm	✓
6.0				TS.13.102.114		12 mm	✓
				TS.13.102.115		15 mm	✓

# Neurosurgery







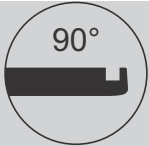
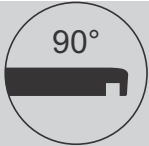
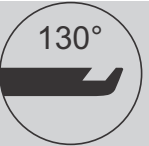

## Standard

### Length - 230 mm







Width (mm)	upward	downward	130° upward	130° downward	Jaw Width	Ejector
						
1.0			-	-	-	
1.5			-	-	-	
2.0			TS.13.103.102	TS.13.103.142	9 mm	
2.5			-	-	-	
3.0			TS.13.103.108	TS.13.103.148	10 mm	✓
4.0			TS.13.103.110	TS.13.103.150	12 mm	✓
5.0			TS.13.103.112	TS.13.103.152	12 mm	✓
6.0			-	-	-	

## Thin

### Length - 180 mm













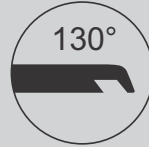



Width (mm)	upward	downward	130° upward	130° downward	Jaw Width	Ejector
						
1.0			TS.13.111.101	TS.13.111.141	8 mm	
1.5			TS.13.111.102		9 mm	
2.0			TS.13.111.104	TS.13.111.144	9 mm	
2.5			TS.13.111.106		10 mm	
3.0			TS.13.111.108	TS.13.111.148	10 mm	✓
4.0			TS.13.111.110	TS.13.111.150	12 mm	✓
5.0			TS.13.111.112	TS.13.111.152	12 mm	✓

### Length - 200 mm

1.0			TS.13.112.101		8 mm	
1.5			TS.13.112.102		9 mm	
2.0			TS.13.112.104		9 mm	
2.5			TS.13.112.106		10 mm	
3.0			TS.13.112.108		10 mm	✓
4.0			TS.13.112.110		12 mm	✓
5.0			TS.13.112.112		12 mm	✓

## Thin

### Lengths - 230 mm

Width (mm)	upward	downward	130° upward	130° downward	Jaw Width	Ejector
						
1.0			-	-	-	
1.5			-	-	-	
2.0			TS.13.113.102	TS.13.113.142	9 mm	
2.5			-	-	-	
3.0			TS.13.113.108	TS.13.113.148	10 mm	✓
4.0			TS.13.113.110	TS.13.113.150	12 mm	✓
5.0			TS.13.113.112	TS.13.113.152	12 mm	✓
<b>Lengths - 280 mm</b>						
1.0			-	-	-	
1.5			-	-	-	
2.0			TS.13.114.102		9 mm	
2.5			-	-	-	
3.0			TS.13.114.108		10 mm	✓
4.0			TS.13.114.110		12 mm	✓
5.0			TS.13.114.112		12 mm	✓

## Non Glare

- Easy disassembly and assembly
- Coating

Coated KERRISON punches

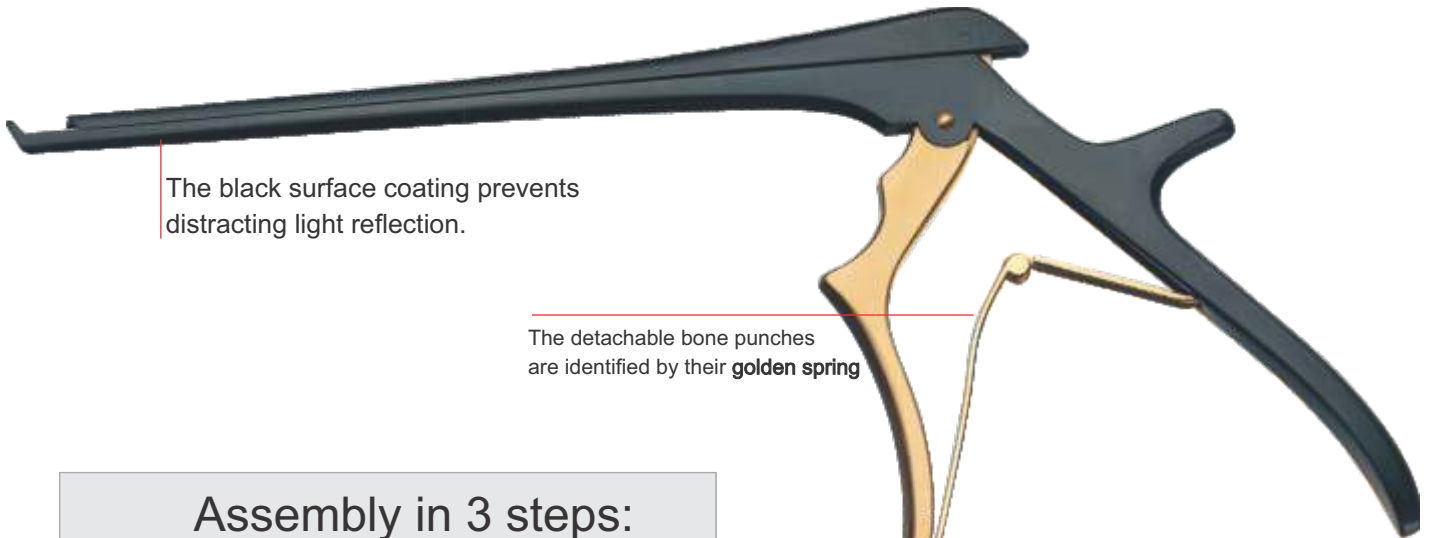

The black surface coating prevents distracting light reflection.

The detachable bone punches are identified by their **golden spring**

## Assembly in 3 steps:

1. Attach the slider and push it forwards.

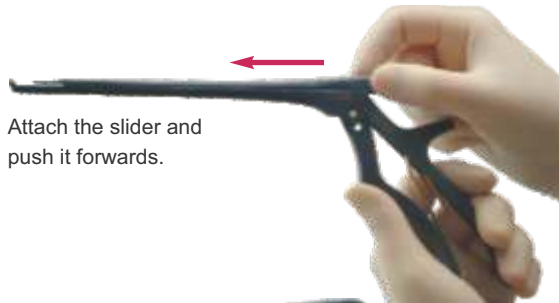

2. Push the inner handle upwards and open the handle.

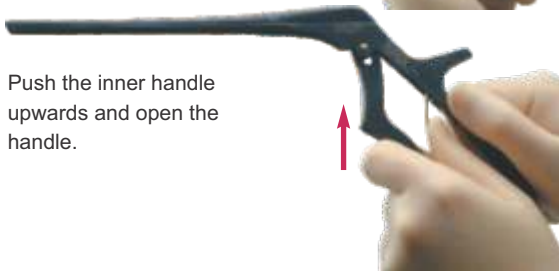

3. Insert the spring in the rear handle.















Kerrison punches with a thin footplate are identified by their golden inner handle.

**Ejector** for easy removal of punched-out material.











Standard      Coated KERRISON punches

Lengths - 180 mm

Width (mm)	upward	downward	130° upward	130° downward	Jaw Width	Ejector
						
1.0		TS.13.101.241		TS.13.101.201	8 mm	
1.5				TS.13.101.202	9 mm	
				TS.13.101.203	15 mm	
2.0		TS.13.101.244		TS.13.101.204	9 mm	
				TS.13.101.205	15 mm	
2.5				TS.13.101.206	10 mm	
				TS.13.101.207	15 mm	
3.0		TS.13.101.248		TS.13.101.208	10 mm	✓
				TS.13.101.209	15 mm	✓
4.0		TS.13.101.250		TS.13.101.210	12 mm	✓
				TS.13.101.211	15 mm	✓
5.0		TS.13.101.252		TS.13.101.212	12 mm	✓
				TS.13.101.213	15 mm	✓
6.0		TS.13.101.254		TS.13.101.214	12 mm	✓
				TS.13.101.215	15 mm	✓

Lengths - 200 mm

1.0			-		-	
1.5				TS.13.102.202	9 mm	
2.0				TS.13.102.204	9 mm	
				TS.13.102.205	15 mm	
2.5				TS.13.102.206	10 mm	
3.0				TS.13.102.208	10 mm	✓
				TS.13.102.209	15 mm	✓
4.0				TS.13.102.210	12 mm	✓
				TS.13.102.211	15 mm	✓
5.0				TS.13.102.212	12 mm	✓
				TS.13.102.213	15 mm	✓
6.0				TS.13.102.214	12 mm	✓
				TS.13.102.215	15 mm	✓

# Neurosurgery

## Thin Coated KERRISON punches

### Lengths - 180 mm

Width (mm)    upward    downward    130° upward    130° downward    Jaw Width    Ejector

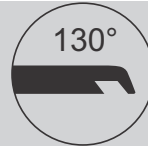
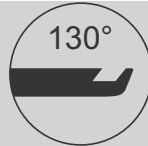
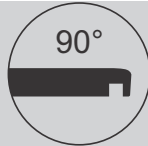
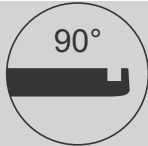

1.0	□				TS.13.111.201	8 mm	
1.5	□				TS.13.111.202	9 mm	
2.0	□				TS.13.111.204	9 mm	
2.5	□				TS.13.111.206	10 mm	
3.0	□				TS.13.111.208	10 mm	✓
4.0	□				TS.13.111.210	12 mm	✓
5.0	□				TS.13.111.212	12 mm	✓
6.0	□				TS.13.101.254	12 mm	✓

### Lengths - 200 mm

1.0	□				TS.13.112.201	8 mm	
1.5	□				TS.13.112.202	9 mm	
2.0	□				TS.13.112.204	9 mm	
2.5	□				TS.13.112.206	10 mm	
3.0	□				TS.13.112.208	10 mm	✓
4.0	□				TS.13.112.210	12 mm	✓
5.0	□				TS.13.112.212	12 mm	✓

### Lengths - 230 mm

2.0	□				TS.13.113.202	9 mm	
3.0	□				TS.13.113.208	10 mm	✓
4.0	□				TS.13.113.210	12 mm	✓
5.0	□				TS.13.113.212	12 mm	✓

### Lengths - 280 mm

2.0	□				TS.13.114.202	9 mm	
3.0	□				TS.13.114.208	10 mm	✓
4.0	□				TS.13.114.210	12 mm	✓
5.0	□				TS.13.114.212	12 mm	✓

## Special KERRISON punches

### Curved KERRISON punch, upbiting

Classic non-detachable bone punch with an upbiting curved jaw for easy removal of bone material, especially from between the vertebral arches.



#### Lengths - 200 mm

Width (mm)	Art. No.	Jaw Width
2.0 □	TS.13.151.02	10 mm
3.0 □	TS.13.151.03	10 mm
4.0 □	TS.13.151.04	10 mm
5.0 □	TS.13.151.05	10 mm







## Bayonet-shaped KERRISON punch, 130° upbiting

Classic non-detachable bayonet-shaped bone punch for optimal vision over the shaft of the instrument in the operating area.

## Special KERRISON punches



Lengths - 240 mm





Width (mm)	Art. No.	Jaw Width
2.0 	TS.13.152.02	10 mm
3.0 	TS.13.152.03	10 mm
4.0 	TS.13.152.04	10 mm
5.0 	TS.13.152.05	10 mm

## Bayonet-shaped KERRISON punch, 130° upbiting

Classic non-detachable bayonet-shaped bone punch for optimal vision over the shaft of the instrument in the operating area.



### Lengths - 240 mm

Width (mm)	Art. No.	Jaw Width
2.0 	TS.13.153.02	10 mm
3.0 	TS.13.153.03	10 mm
4.0 	TS.13.153.04	10 mm
5.0 	TS.13.153.05	10 mm

For removal of intervertebral disc tissue we offer an extensive assortment of rongeurs. Your advantages are:

1. All rongeurs are also available as detachable models enabling an effective cleaning. Connections and joints are freely accessible which avoids unwashed areas. By effected easily and quickly. The detached rongeurs stay stay one part and can be assembled again without any problems.
2. The black coating guarantees a reflexion free working as well as hard surface.



The detached rongeur remains one part.

The black coating aids reflections.

The diameter is marked on the rongeurs twice.

The golden handle refers to the detachability.

## Disassembly



Hold the rongeur with both hands and pull the release button.



For cleaning purposes please move the sliding part upwards.

## Assembly



Please insert the sliding part so that the release button is over the loop of the handle part.



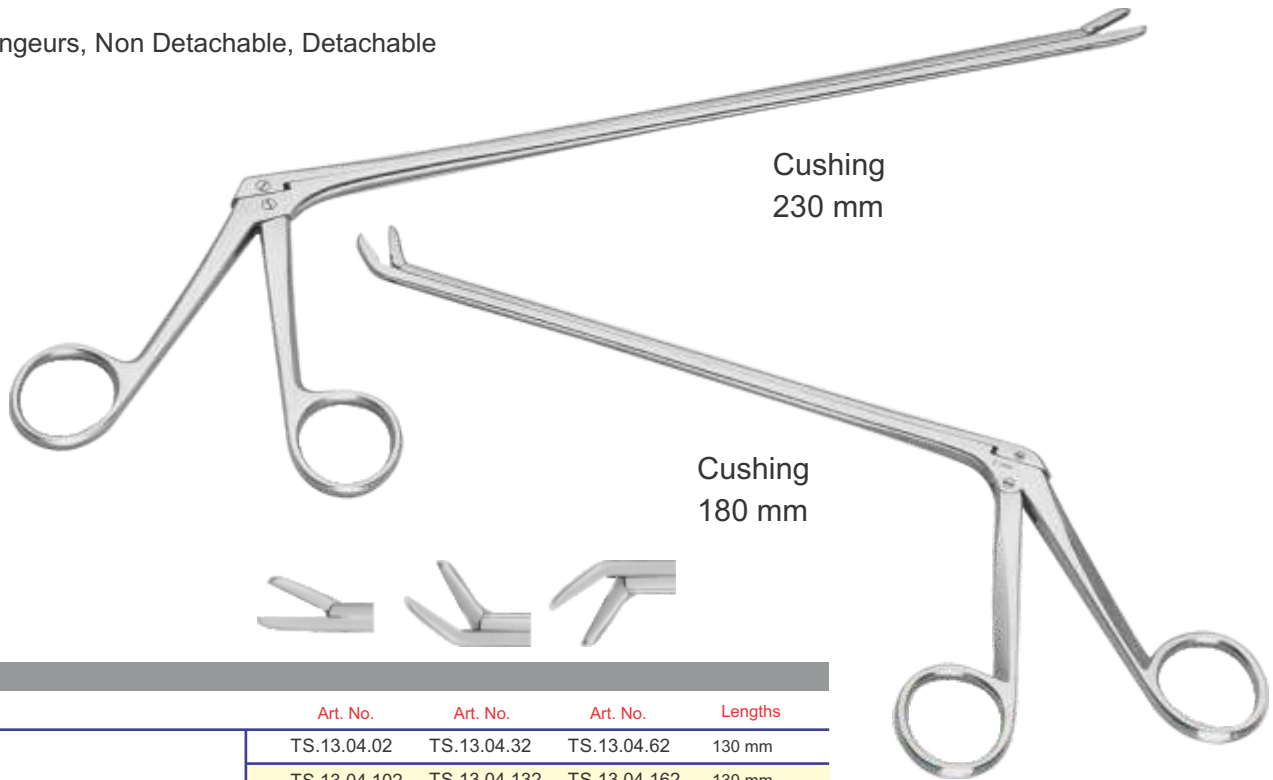

Please keep the release button pulled and push the sliding part down.

Rongeurs, Non Detachable, Detachable



Cushing  
230 mm

Cushing  
180 mm



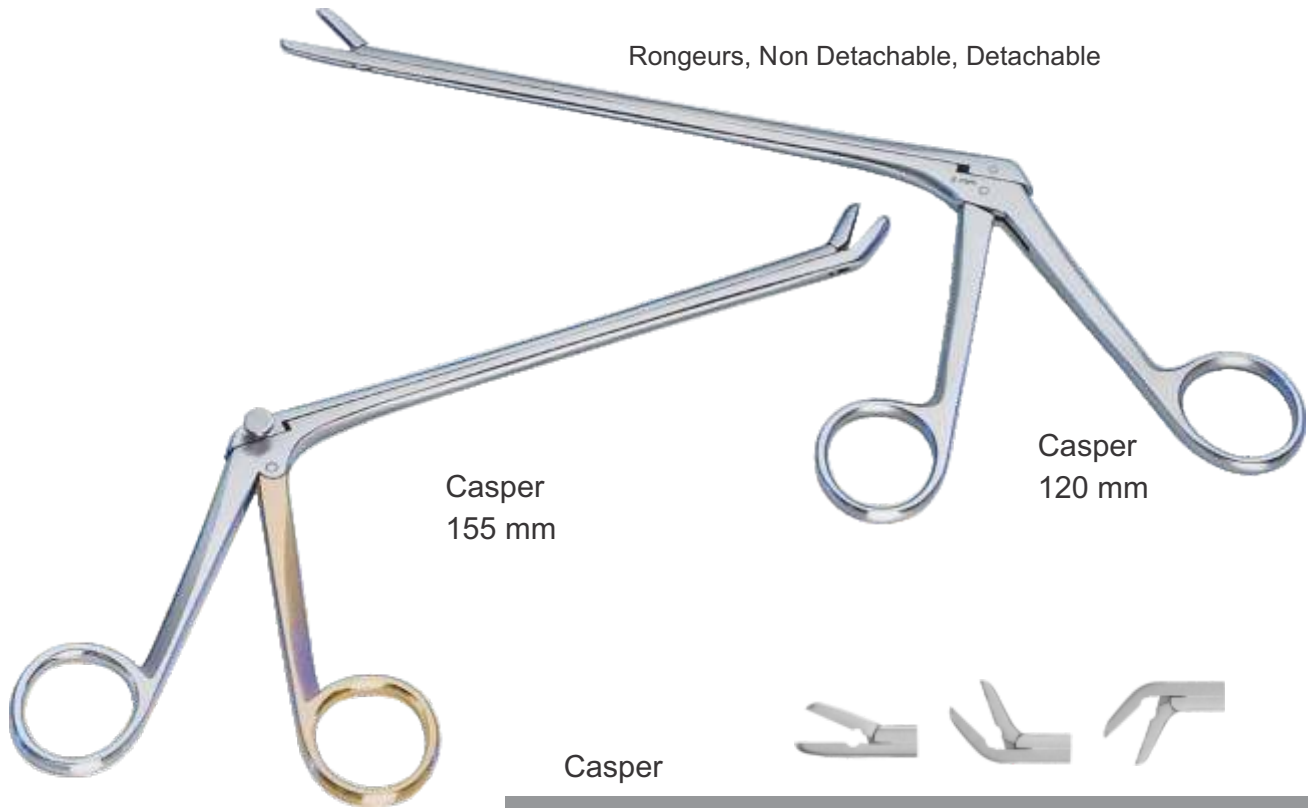

	Art. No.	Art. No.	Art. No.	Lengths
<b>CUSHING</b> 2 x 10 mm 	TS.13.04.02	TS.13.04.32	TS.13.04.62	130 mm
	TS.13.04.102	TS.13.04.132	TS.13.04.162	130 mm
	TS.13.04.15	TS.13.04.45	TS.13.04.75	150 mm
	TS.13.04.115	TS.13.04.145	TS.13.04.175	150 mm
	TS.13.04.22	TS.13.04.52	TS.13.04.82	180 mm
	TS.13.04.122	TS.13.04.152	TS.13.04.182	180 mm
	TS.13.04.23	TS.13.04.53	TS.13.04.83	230 mm
	TS.13.04.123	TS.13.04.153	TS.13.04.183	230 mm
	TS.13.04.28	TS.13.04.58	TS.13.04.88	280 mm
	TS.13.128	TS.13.04.158	TS.13.04.188	280 mm
<b>LOVE-GRUENWALD</b> 3 x 10 mm 	TS.13.08.03	TS.13.08.33	TS.13.08.63	130 mm
	TS.13.08.103	TS.13.08.133	TS.13.08.163	130 mm
	TS.13.08.15	TS.13.08.45	TS.13.08.75	150 mm
	TS.13.08.115	TS.13.08.145	TS.13.08.175	150 mm
	TS.13.08.23	TS.13.08.53	TS.13.08.83	180 mm
	TS.13.08.123	TS.13.08.153	TS.13.08.183	180 mm
	TS.13.08.24	TS.13.08.54	TS.13.08.84	230 mm
	TS.13.08.124	TS.13.08.154	TS.13.08.184	230 mm
	TS.13.08.28	TS.13.08.58	TS.13.08.88	280 mm
	TS.13.08.128	TS.13.08.158	TS.13.08.188	280 mm
<b>SPURLING</b> 4 x 10 mm 	TS.13.11.83	TS.13.11.93	TS.13.11.94	130 mm
	TS.13.11.183	TS.13.11.193	TS.13.11.194	130 mm
	TS.13.11.85	TS.13.11.95	TS.13.11.96	150 mm
	TS.13.11.185	TS.13.11.195	TS.13.11.196	150 mm
	TS.13.11.88	TS.13.11.98	TS.13.11.99	180 mm
	TS.13.11.188	TS.13.11.198	TS.13.11.199	180 mm
	TS.13.11.89	TS.13.11.99	TS.13.11.100	230 mm
	TS.13.11.189	TS.13.11.199	TS.13.11.201	230 mm
	TS.13.11.90	TS.13.11.101	TS.13.11.102	280 mm
	TS.13.11.190	TS.13.11.201	TS.13.11.202	280 mm

non detachable  
 detachable

Rongeurs, Non Detachable, Detachable



Casper





	Art. No.	Art. No.	Art. No.	Lengths
2 mm 	TS.13.05.54	TS.13.05.64	TS.13.05.74	120 mm
	TS.13.05.154	TS.13.05.164	TS.13.05.174	120 mm
	TS.13.05.56	TS.13.05.66	TS.13.05.76	155 mm
	TS.13.05.156	TS.13.05.166	TS.13.05.176	155 mm
	TS.13.05.58	TS.13.05.68	TS.13.05.78	180 mm
	TS.13.05.158	TS.13.05.168	TS.13.05.178	180 mm
3 mm 	TS.13.06.54	TS.13.06.64	TS.13.06.74	120 mm
	TS.13.06.154	TS.13.06.164	TS.13.06.174	120 mm
	TS.13.06.56	TS.13.06.66	TS.13.06.76	155 mm
	TS.13.06.156	TS.13.06.166	TS.13.06.176	155 mm
	TS.13.06.58	TS.13.06.68	TS.13.06.78	180 mm
	TS.13.06.158	TS.13.06.168	TS.13.06.178	180 mm
4 mm 	TS.13.07.54	TS.13.07.64	TS.13.07.74	120 mm
	TS.13.07.154	TS.13.07.164	TS.13.07.174	120 mm
	TS.13.07.56	TS.13.07.66	TS.13.07.76	155 mm
	TS.13.07.156	TS.13.07.166	TS.13.07.176	155 mm
	TS.13.07.58	TS.13.07.68	TS.13.07.78	180 mm
	TS.13.07.158	TS.13.07.168	TS.13.07.178	180 mm
5 mm 	TS.13.09.54	TS.13.09.64	TS.13.09.74	120 mm
	TS.13.09.154	TS.13.09.164	TS.13.09.174	120 mm
	TS.13.09.56	TS.13.09.66	TS.13.09.76	155 mm
	TS.13.09.156	TS.13.09.166	TS.13.09.176	155 mm
	TS.13.09.58	TS.13.09.68	TS.13.09.78	180 mm
	TS.13.09.158	TS.13.09.168	TS.13.09.178	180 mm

non detachable

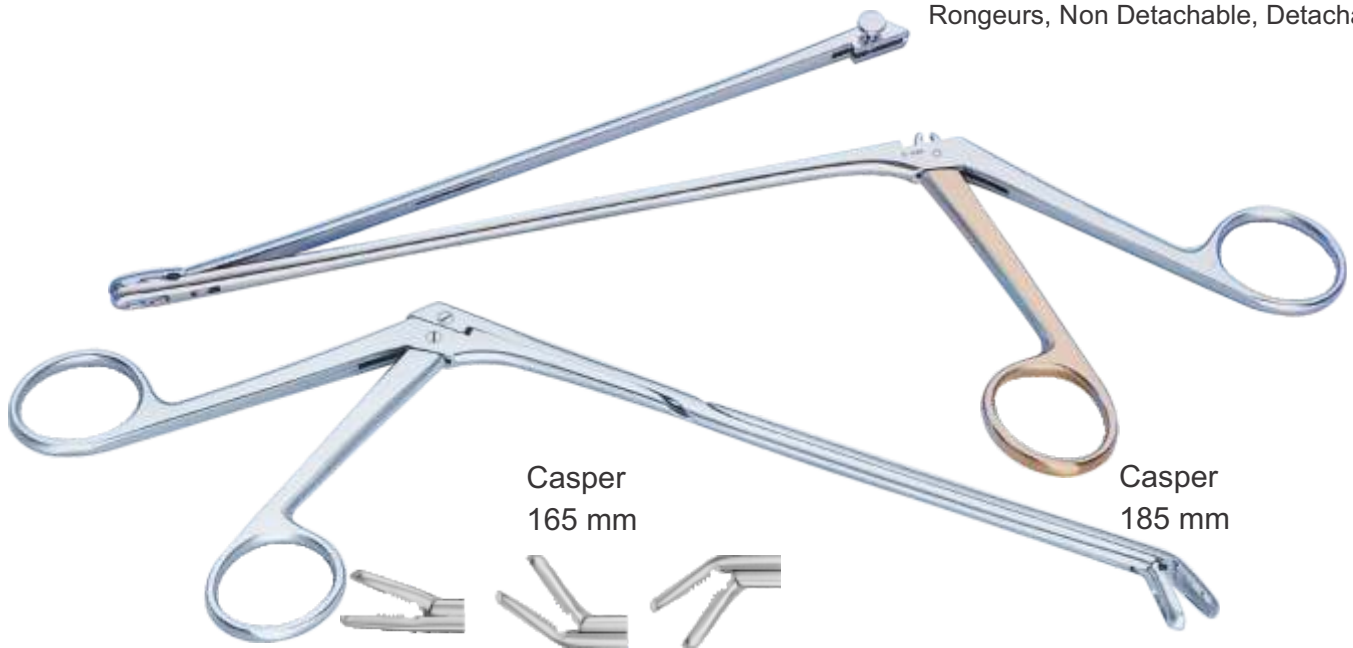
detachable

Rongeurs, Non Detachable, Detachable



	Art. No.	Art. No.	Art. No.	Lengths
2 x 12 mm 	TS.13.05.04	TS.13.05.34	TS.13.05.44	140 mm
	TS.13.05.104	TS.13.05.134	TS.13.05.144	140 mm
	TS.13.05.06	TS.13.05.36	TS.13.05.46	160 mm
	TS.13.05.106	TS.13.05.136	TS.13.05.146	160 mm
	TS.13.05.08	TS.13.05.38	TS.13.05.48	185 mm
	TS.13.05.108	TS.13.05.138	TS.13.05.148	185 mm
3 x 12 mm 	TS.13.06.04	TS.13.06.34	TS.13.06.44	140 mm
	TS.13.06.104	TS.13.06.134	TS.13.06.144	140 mm
	TS.13.06.06	TS.13.06.36	TS.13.06.46	160 mm
	TS.13.06.106	TS.13.06.136	TS.13.06.146	160 mm
	TS.13.06.08	TS.13.06.38	TS.13.06.48	185 mm
	TS.13.06.108	TS.13.06.138	TS.13.06.148	185 mm
4 x 14 mm 	TS.13.07.04	TS.13.07.34	TS.13.07.44	140 mm
	TS.13.07.104	TS.13.07.134	TS.13.07.144	140 mm
	TS.13.07.06	TS.13.07.36	TS.13.07.46	160 mm
	TS.13.07.106	TS.13.07.136	TS.13.07.146	160 mm
	TS.13.07.08	TS.13.07.38	TS.13.07.48	185 mm
	TS.13.07.108	TS.13.07.138	TS.13.07.148	185 mm
5 x 14 mm 	TS.13.09.04	TS.13.09.34	TS.13.09.44	140 mm
	TS.13.09.104	TS.13.09.134	TS.13.09.144	140 mm
	TS.13.09.06	TS.13.09.36	TS.13.09.46	160 mm
	TS.13.09.106	TS.13.09.136	TS.13.09.146	160 mm
	TS.13.09.08	TS.13.09.38	TS.13.09.48	185 mm
	TS.13.09.108	TS.13.09.138	TS.13.09.148	185 mm
6 x 16 mm 	TS.13.10.04	TS.13.10.34	TS.13.10.44	140 mm
	TS.13.10.104	TS.13.10.134	TS.13.10.144	140 mm
	TS.13.10.06	TS.13.10.36	TS.13.10.46	160 mm
	TS.13.10.106	TS.13.10.136	TS.13.10.146	160 mm
	TS.13.10.08	TS.13.10.38	TS.13.10.48	185 mm
	TS.13.10.108	TS.13.10.138	TS.13.10.148	185 mm



Mouth fenestrated and serrated

non detachable  
 detachable

## Laminectomy Rongeurs

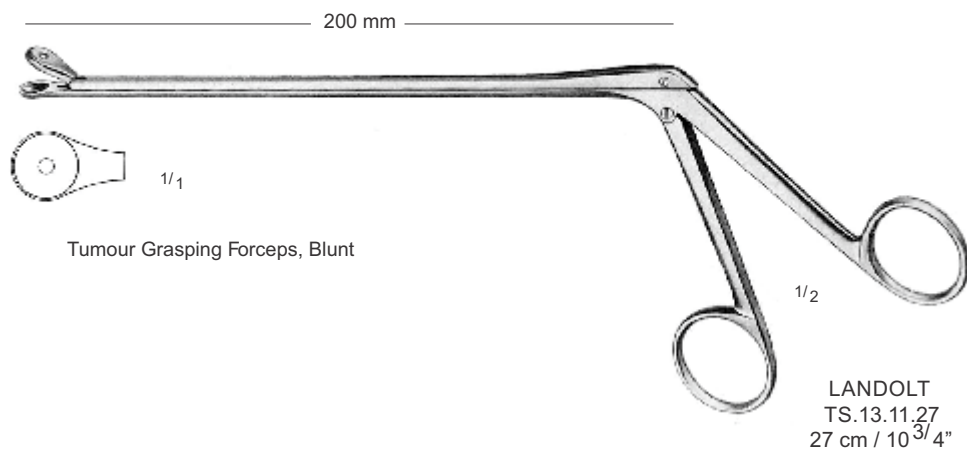
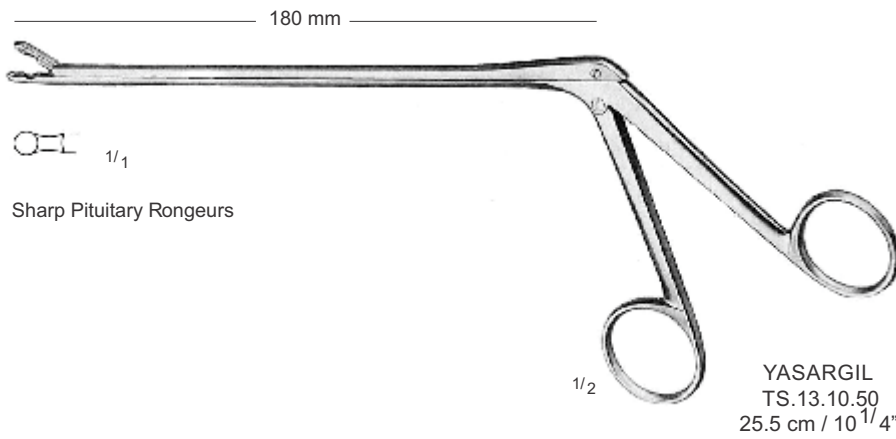
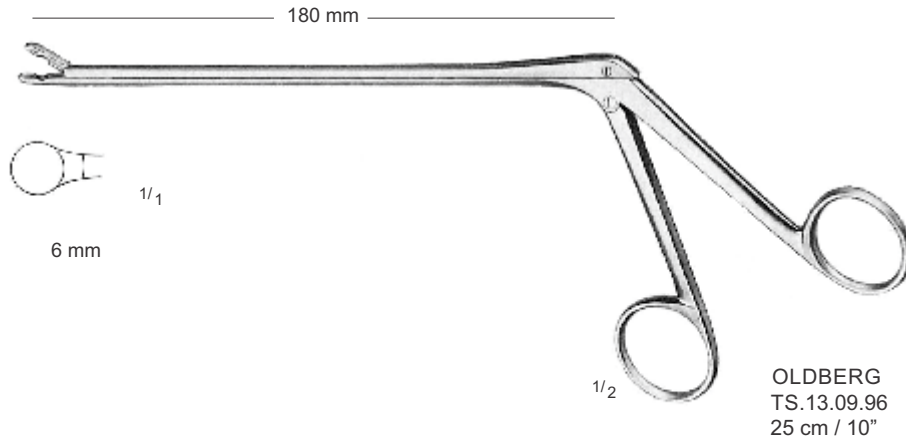

## Brain Spatulas, Dura Dissectors

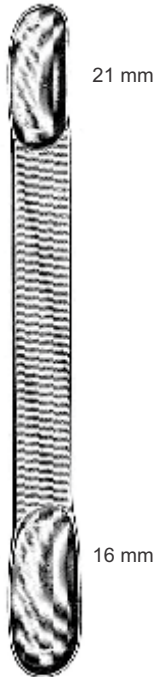

**CUSHING**  
TS.13.15.17 – 17 cm / 6<sup>3</sup>/<sub>4</sub>"  
TS.13.15.20 – 20 cm / 8"

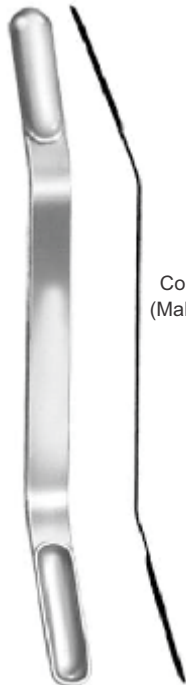

Concave  
(Malleable)

**OILVECRONA**  
18 cm (7<sup>1</sup>/<sub>8</sub>")  
TS.13.16.09 – 7 + 9 mm  
TS.13.16.13 – 11 + 13 mm  
TS.13.16.18 – 15 + 18 mm  
TS.13.16.22 – 18 + 22 mm

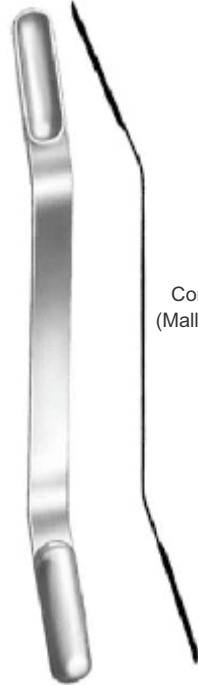

Convex  
(Malleable)

**OILVECRONA**  
18 cm (7<sup>1</sup>/<sub>8</sub>")  
TS.13.17.39 – 7 + 9 mm  
TS.13.17.43 – 11 + 13 mm  
TS.13.17.48 – 15 + 18 mm  
TS.13.17.52 – 18 + 22 mm



1/1



**FRAZIER**  
TS.13.18.01  
15 cm / 6"



1/2



**HOEN**  
TS.13.18.02  
15 cm / 6"



1/2



**HOEN**  
TS.13.18.03  
15 cm / 6"

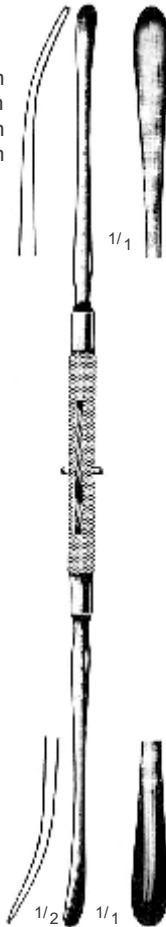

1/2

1/1

**DAVIS**  
TS.13.41.24  
24.5 cm / 9<sup>3</sup>/<sub>4</sub>"



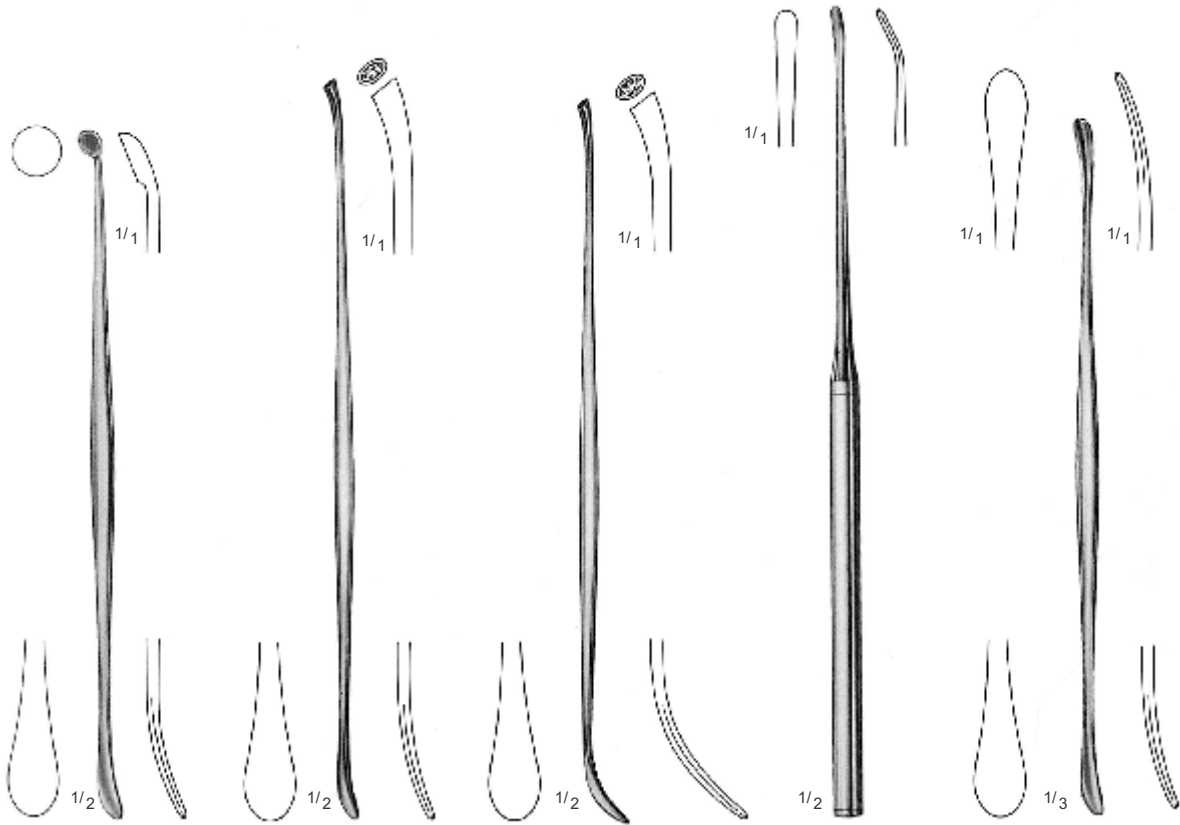

PENFIELD  
TS.14.37.51  
Fig. 1  
17.5 cm / 7"

PENFIELD  
TS.14.37.52  
Fig. 2  
19.5 cm / 7<sup>3</sup>/<sub>4</sub>"

PENFIELD  
TS.14.37.53  
Fig. 3  
19.5 cm / 7<sup>3</sup>/<sub>4</sub>"

PENFIELD  
TS.14.38.54  
Fig. 4  
21.5 cm / 8<sup>1</sup>/<sub>2</sub>"

PENFIELD  
TS.14.39.55  
Fig. 5  
29 cm / 11<sup>1</sup>/<sub>2</sub>"

# Neurosurgery

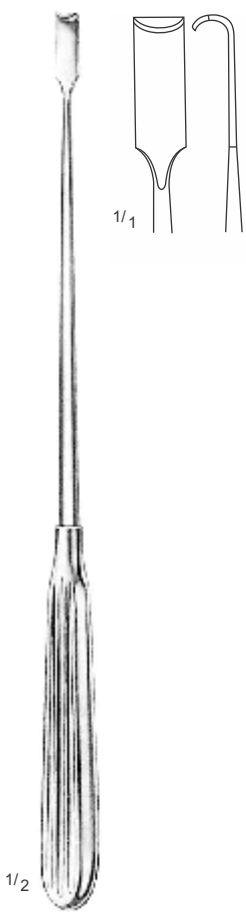

SCOVILLE  
 TS.14.42.50  
 23 cm / 9"

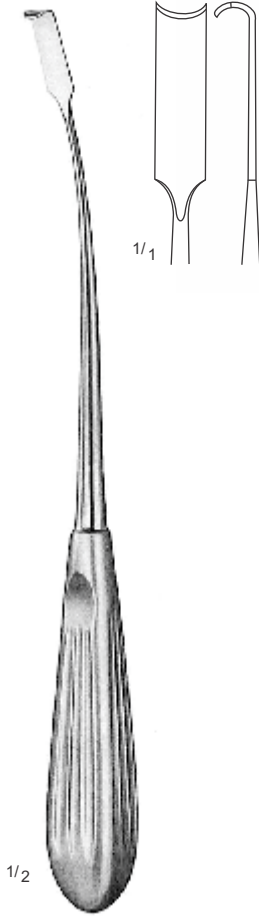

HOLSHER  
 TS.14.42.51  
 24 cm / 9 1/2"

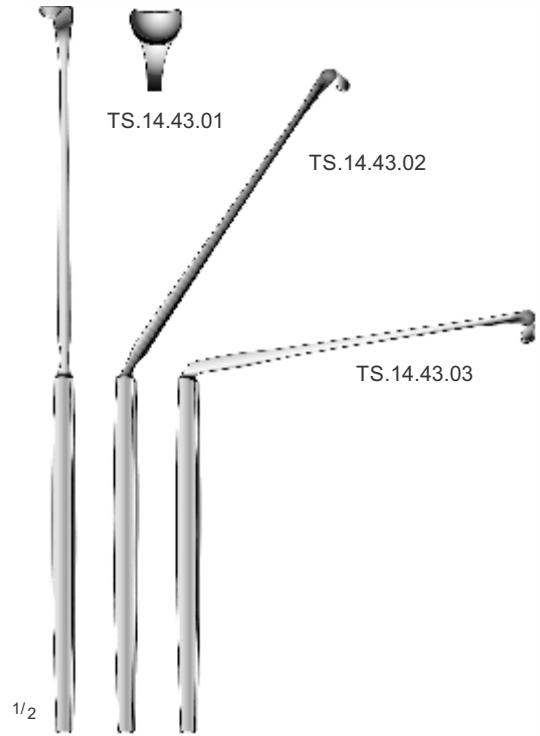

LOVE  
 TS.14.43.01 – TS.14.43.03

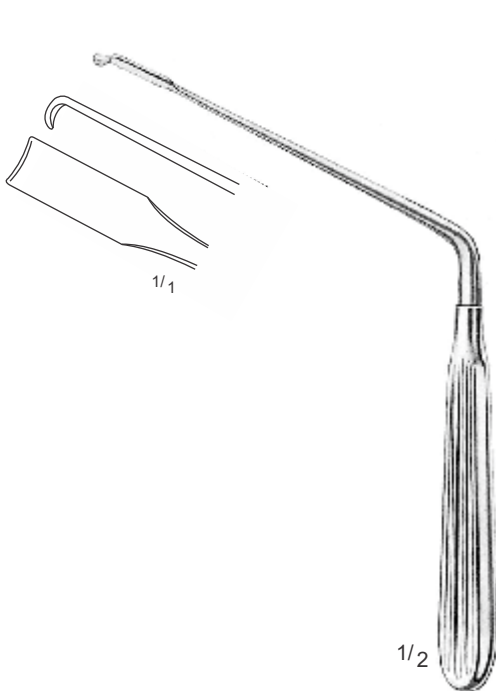

SCOVILLE  
 TS.14.43.51  
 23 cm / 9"

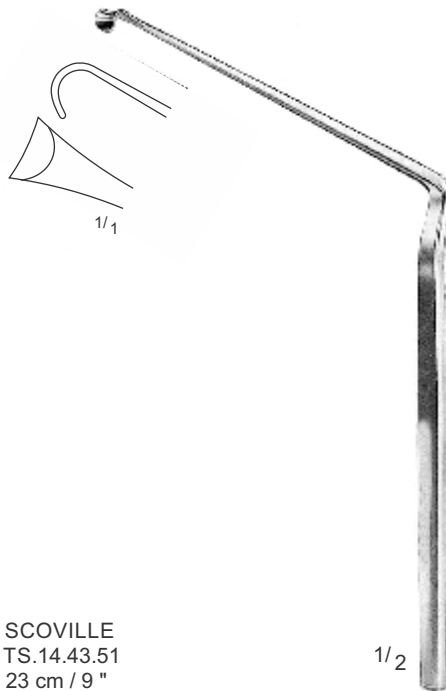

PROFESSIONAL  
 TS.14.44.52  
 21 cm / 8 1/4"

# Neurosurgery

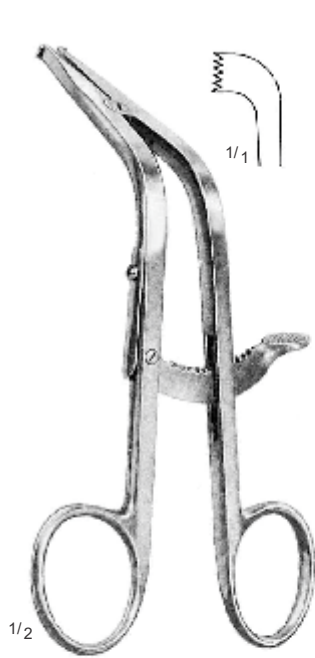

1/2

CLOWARD  
TS.14.49.75  
16 cm / 6 1/4"

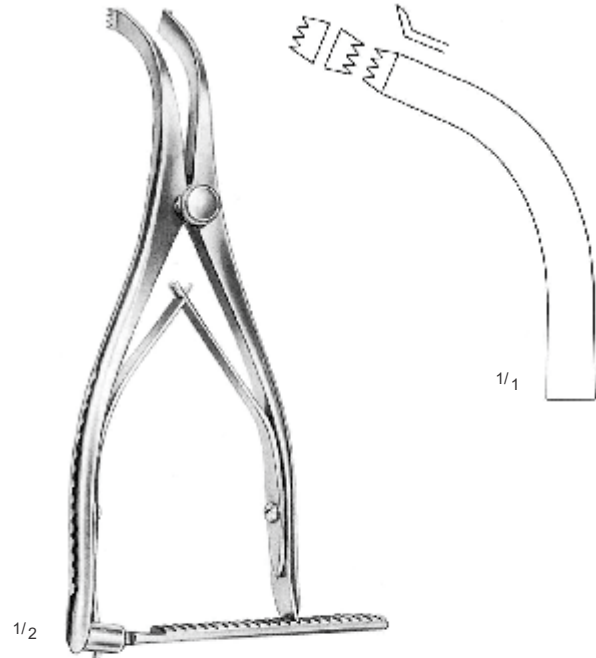

1/2

INGE  
TS.14.50.05  
16 cm / 6 1/4"

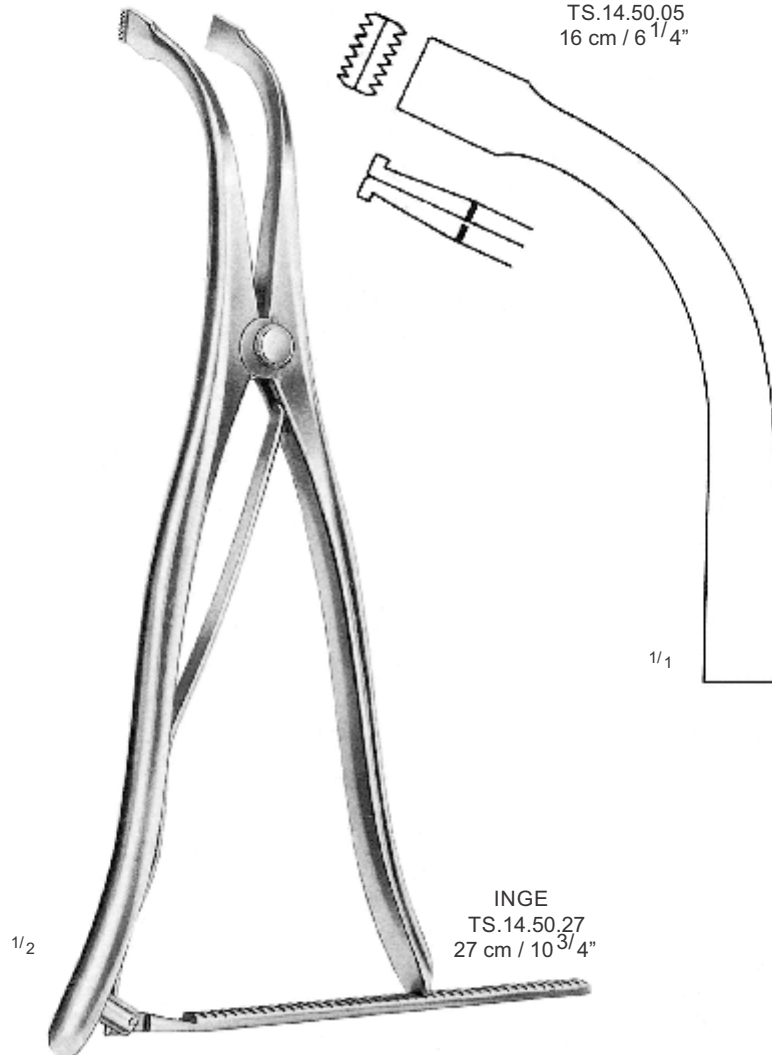

1/2

INGE  
TS.14.50.27  
27 cm / 10 3/4"

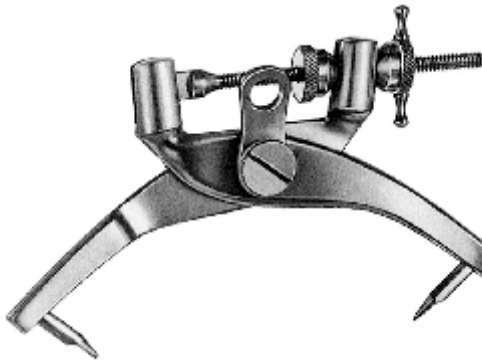

CRUTCHFIELD  
TS.14.52.01

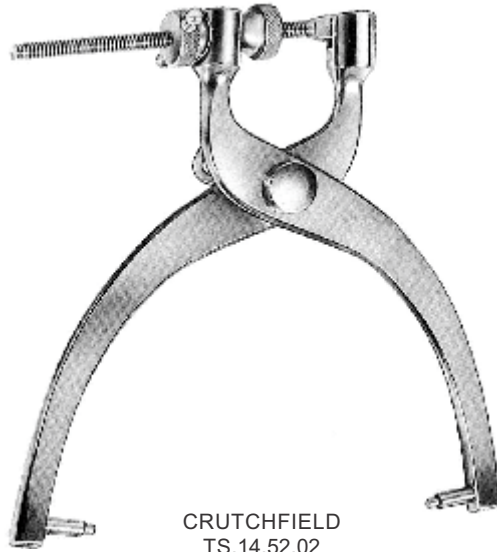

CRUTCHFIELD  
TS.14.52.02



TS.14.52.04  
ø 3.5 mm



TS.14.52.05  
ø 5 mm



EXTENSION PIECE  
ONLY  
TS.14.53.05



TS.14.54.09  
ø 9 mm



TS.14.54.14  
ø 14 mm



TS.14.55.16  
ø 16 mm



TS.14.55.22  
ø 22 mm



BRACE ONLY  
TS.14.54.03

HUDSON  
Cranial Drill  
Complete with 4  
burs No.,  
TS.14.54.09  
TS.14.54.14  
TS.14.55.16  
TS.14.55.22



CUSHING  
TS.14.56.34  
ø 13 mm



McKENZIE  
TS.14.57.43  
ø 13 mm



D'ERRICO  
TS.14.58.76  
ø 16 mm

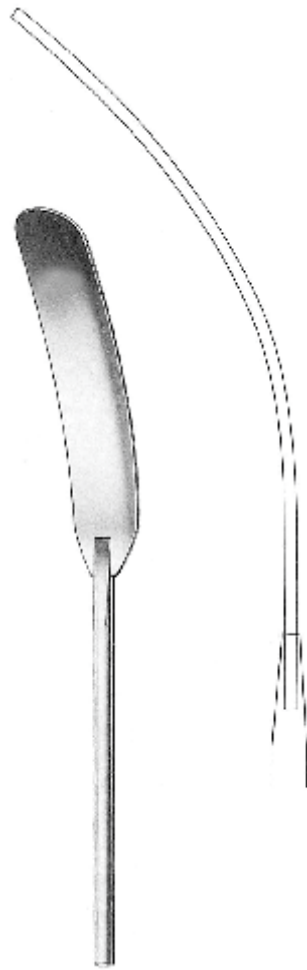

HEIFETZ  
20 cm / 8"

- TS.14.70.68 8 mm
- TS.14.70.71 11 mm
- TS.14.70.74 14 mm
- TS.14.70.77 17 mm
- TS.14.70.80 20 mm



LEYLEA  
TS.14.61.00  
Complete with two flexible arms no.TS.14. 61.02,  
one fixation base no.TS.14. 61.01 and two clamps  
No. TS.14. 61.03 for holding brain spatulas



Urology Instruments

# Urology Instruments

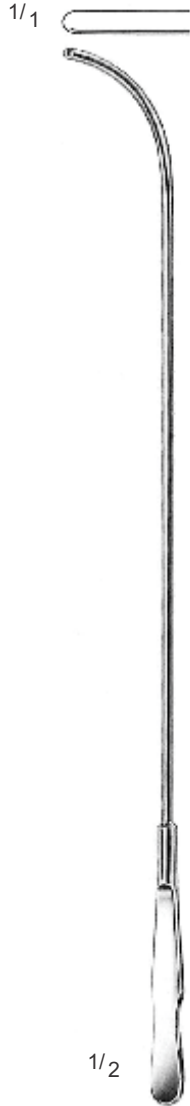

VAN BUREN  
TS.14.06.08 TS.14.06.30  
27.5 cm / 11"  
CHARRIER(French)  
No. (8-30)

CHARRIERE  
(French)

VAN BUREN	GUYON
TS.14.06.08 8	-
TS.14.06.10 10	TS.14.07.10
11	TS.14.07.11
TS.14.06.12 12	TS.14.07.12
13	TS.14.07.13
TS.14.06.14 14	TS.14.07.14
15	TS.14.07.15
TS.14.06.16 16	TS.14.07.16
17	TS.14.07.17
TS.14.06.18 18	TS.14.07.18
19	TS.14.07.19
TS.14.06.20 20	TS.14.07.20
21	TS.14.07.21
TS.14.06.22 22	TS.14.07.22
23	TS.14.07.23
TS.14.06.24 24	TS.14.07.24
25	TS.14.07.25
TS.14.06.26 26	TS.14.07.26
27	TS.14.07.27
TS.14.06.28 28	TS.14.07.28
29	TS.14.07.29
TS.14.06.30 30	TS.14.07.30
TS.14.06.00	TS.14.07.00
(Set of 12, pcs)	(Set 21, pcs)

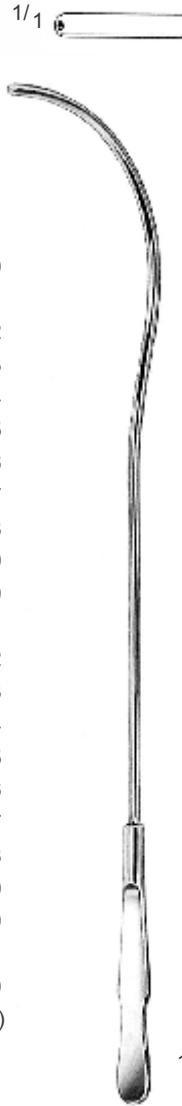

GUYON  
TS.14.07.10 TS.14.07.30 TS.14.07.56 TS.14.07.66  
27.5 cm / 11"  
CHARRIER(French)  
No. (10-30)



CHARRIERE  
(French)  
TS.14.07.56 - 6  
TS.14.07.58 - 8  
TS.14.07.60 - 10  
TS.14.07.62 - 12  
TS.14.07.63 - 13  
TS.14.07.64 - 14  
TS.14.07.65 - 15  
TS.14.07.66 - 16



# Urology Instruments



GUYON  
TS.14.08.20  
36 cm/ 14 $\frac{1}{4}$ "



GUYON  
TS.14.09.30  
36 cm/ 14 $\frac{1}{4}$ "



DITTEL  
TS.14.10.60  
39 cm/ 15 $\frac{1}{2}$ "



TS.14.11.70  
39 cm/ 15 $\frac{1}{2}$ "

# Urology Instruments



35 mm

LEGUEU  
TS.14.16.15  
27 cm / 10½"

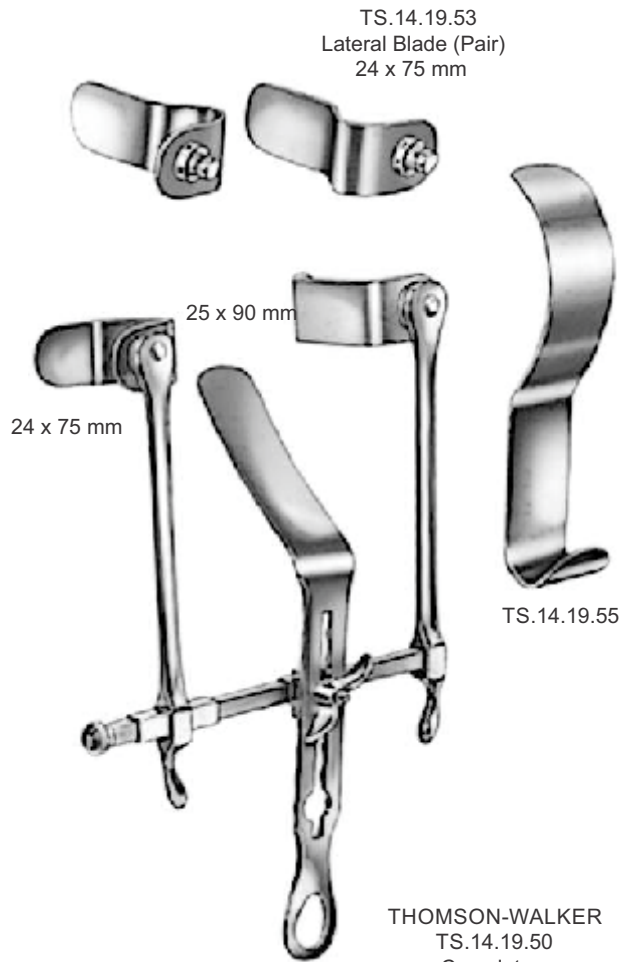

TS.14.19.53  
Lateral Blade (Pair)  
24 x 75 mm

24 x 75 mm

25 x 90 mm

TS.14.19.55

THOMSON-WALKER  
TS.14.19.50  
Complete

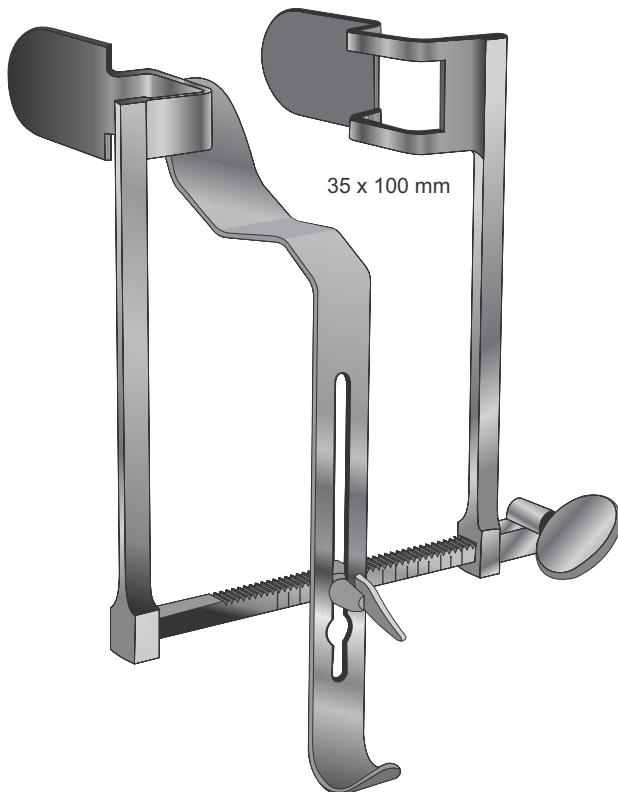

35 x 100 mm

HRYNTSHCAK  
TS.14.20.70

# Urology Instruments

11 x 50 mm

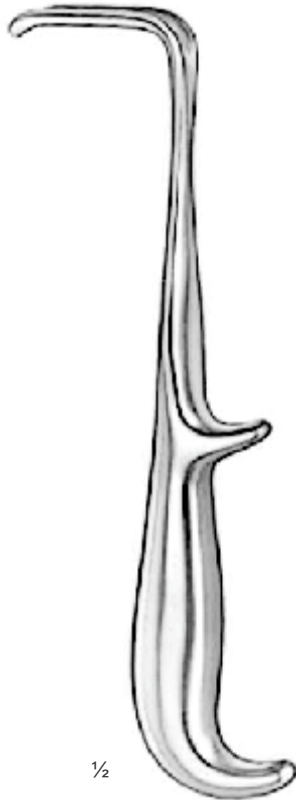

YOUNG  
TS.14.23.01  
21 cm / 8 1/4"

38 x 64 mm



YOUNG  
TS.14.24.02  
22 cm / 8 3/4"

25 x 25 mm



YOUNG  
TS.14.25.03  
21 cm / 8 1/4"

39 x 35 mm

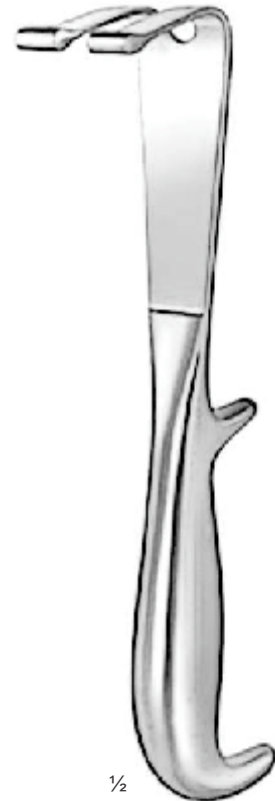

YOUNG  
TS.14.28.04  
22 cm / 8 3/4"

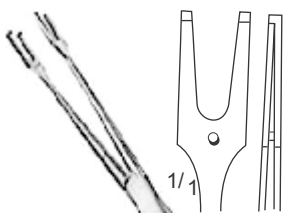

1/3



MILLIN  
TS.14.26.03  
24 cm / 9 1/2"

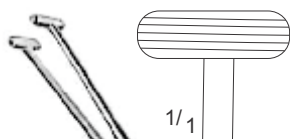

1/3



MILLIN  
TS.14.31.01  
23 cm / 9"



1/3



MILLIN  
TS.14.32.02  
23 cm / 9"

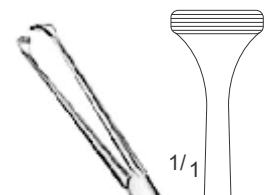

1/3



MILLIN  
TS.14.32.04  
23 cm / 9"

L = Length

W = Width

D = Depth

ø = Diameter



1/2

MILLIN  
TS.14.33.50  
28 cm / 11"



1/2

STRAUSS  
TS.14.04.10  
12 cm / 4 3/4"



1/2

STOCKMANN  
TS.14.05.05  
8 cm / 3"

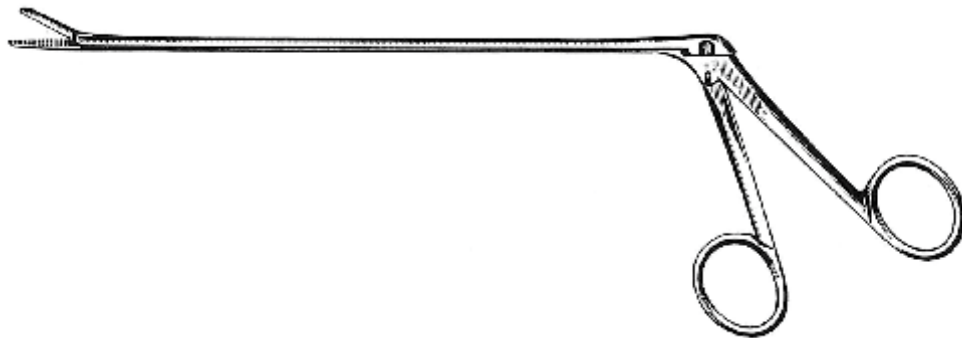

MATHIEU  
TS.14.21.20 TS.14.21.28  
20 cm / 8" 28 cm / 11"

# Urology Instruments

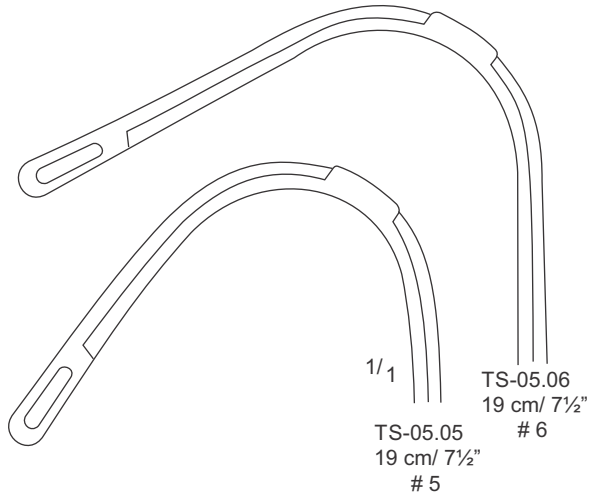

1/2

RANDALL  
TS-05.01 TS-05.06

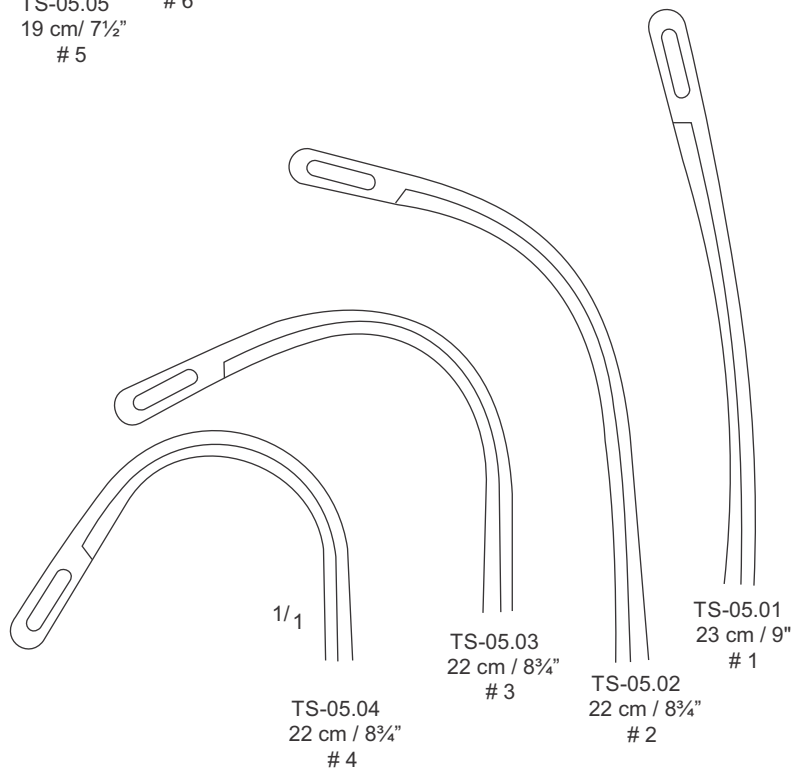

# Urology Instruments



GUYON  
 TS-15.20 TS-15.24

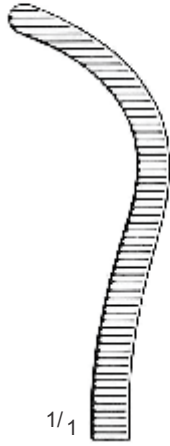

TS-15.20  
 20 cm / 8"

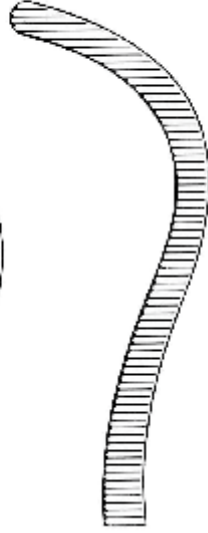

TS-15.22  
 22 cm / 8 3/4"

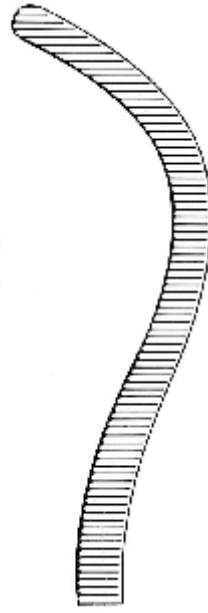

TS-15.24  
 24 cm / 9 1/2"

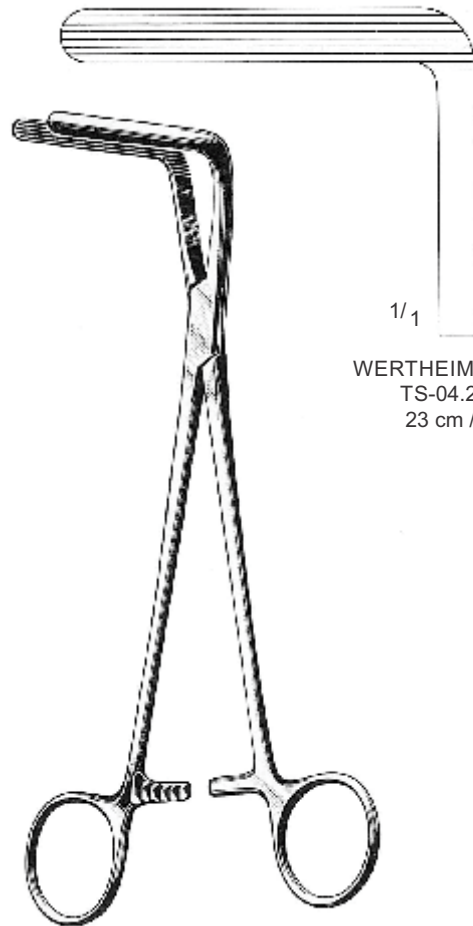

WERTHEIM-CULLEN  
 TS-04.23  
 23 cm / 9"

# Urology Instruments

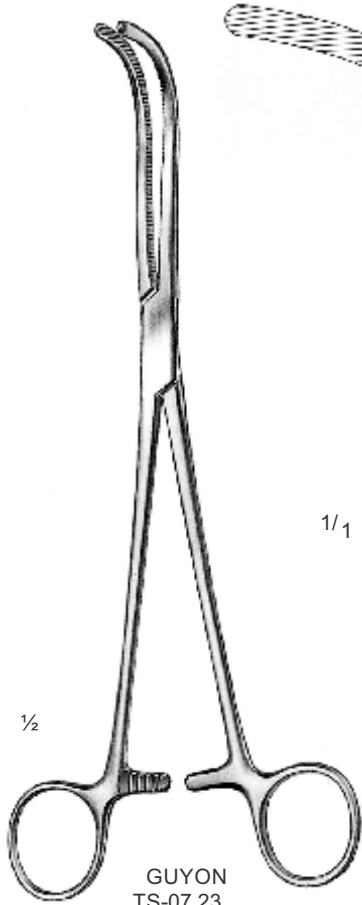

GUYON  
TS-07.23



GUYON-MAYO  
TS-08.23  
23 cm/ 9"

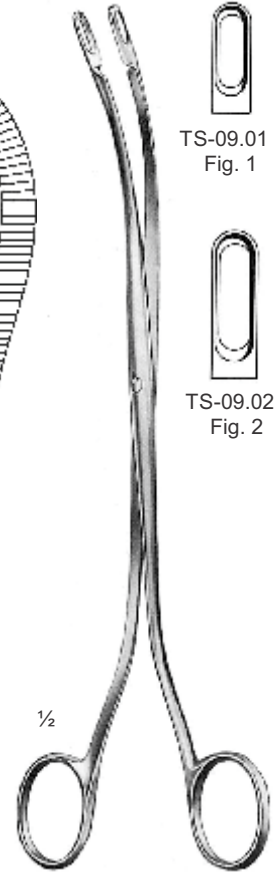

DESJARDINS  
TS-09.01 TS-09.02  
23 cm/ 9"

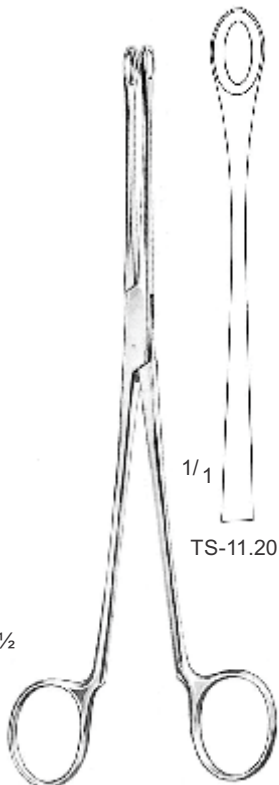

BLAKE  
20 cm/ 8"

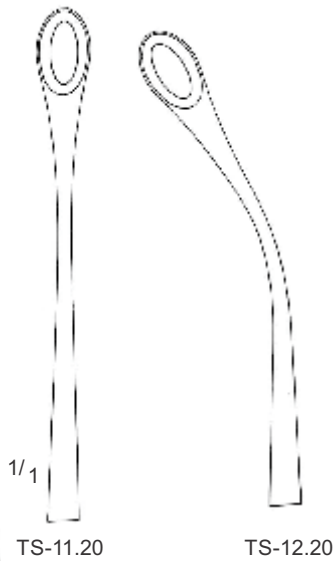

TS-12.20

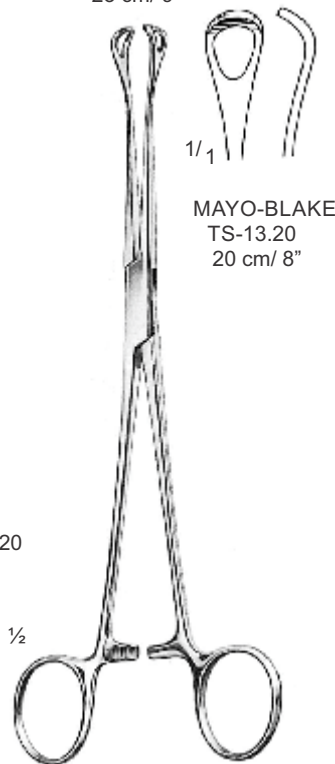

MAYO-BLAKE  
TS-13.20  
20 cm/ 8"

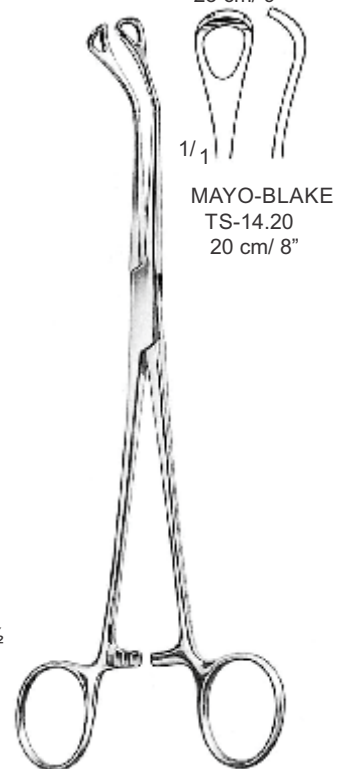

MAYO-BLAKE  
TS-14.20  
20 cm/ 8"

# Urology Instruments



**THOREK**  
TS-16.19 – 19 cm / 7½"  
TS-16.23 – 23 cm / 9"

Side View

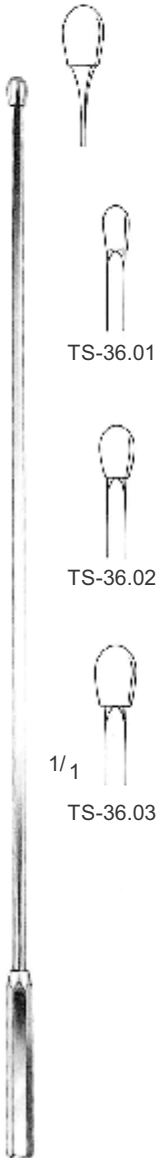

**DESJARDINS**  
TS-36.01 TS-36.03  
26 cm / 10¼"  
  
TS-36.00  
Set of 3 probes



**BAKES**  
TS-32.01 TS-32.13  
32 cm / 13"  
Malleable Shaft  
TS-32.00  
Set of 13 dilators

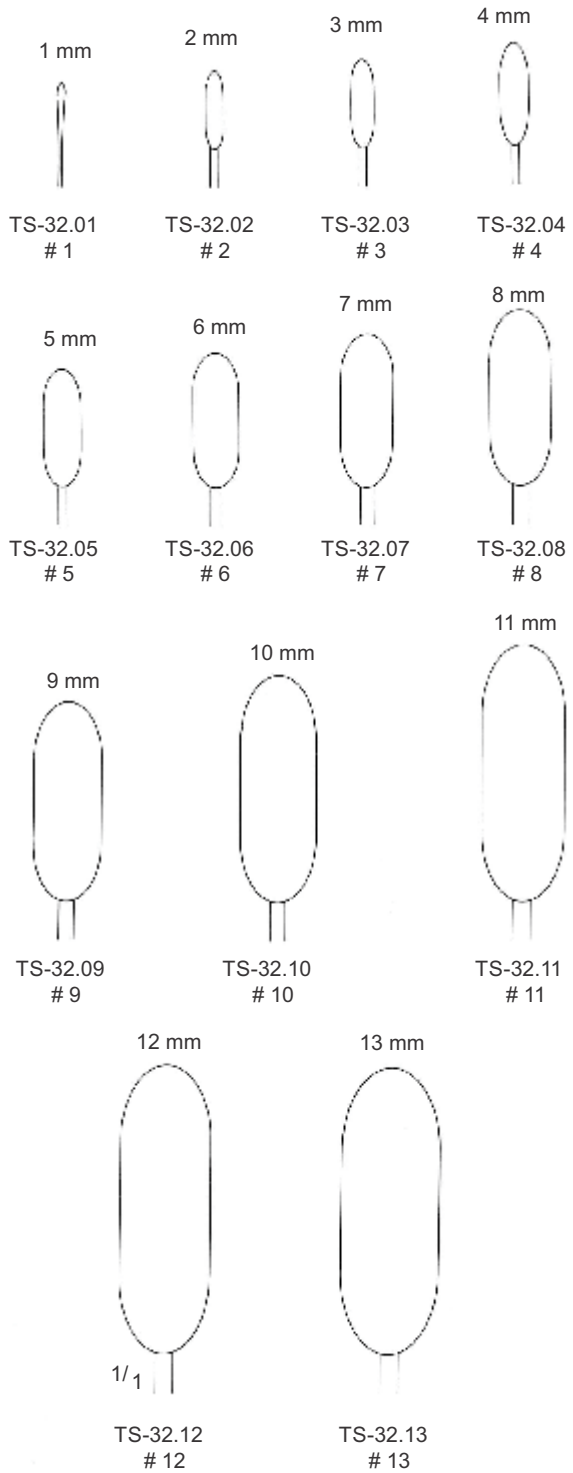



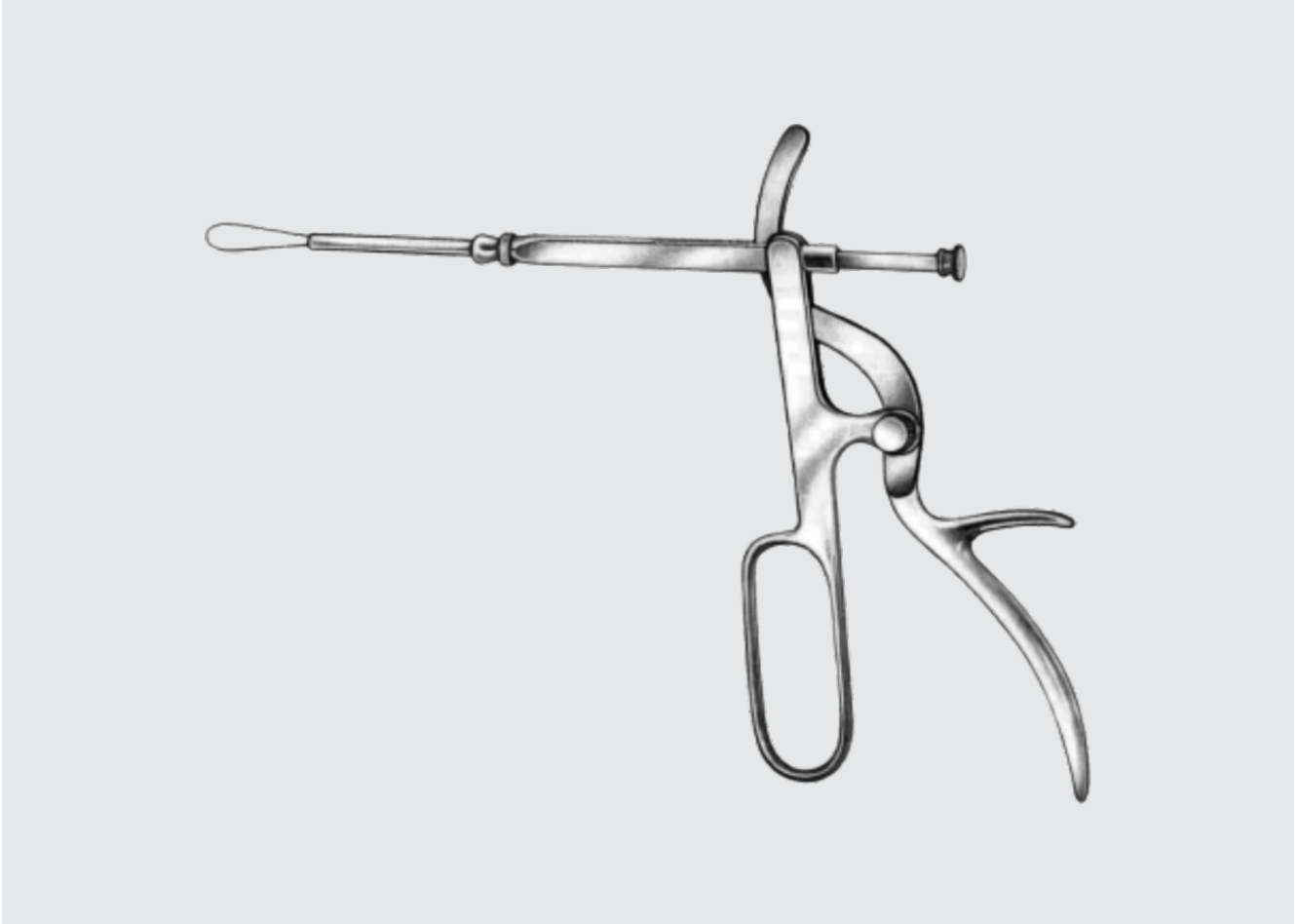

Mouth & Throat Instruments

Delivery with 3 wires, pre shaped

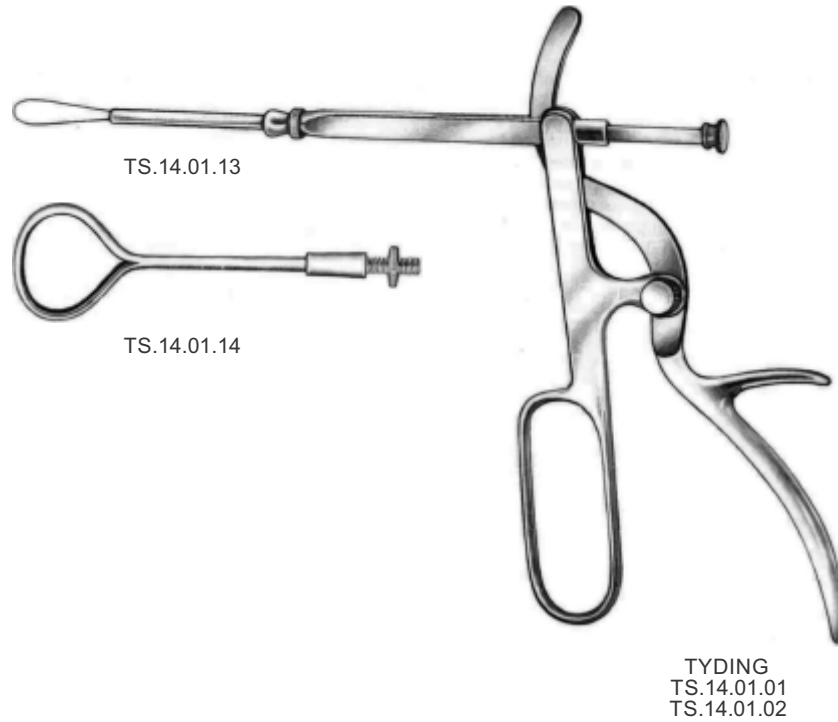

TS.14.01.01  
TYDING Tonsil snare with straight tip

TS.14.01.02  
TYDING Tonsil snare with straight and vedder looped tip

TS.14.01.13  
Straight tip only

TS.14.01.14  
Vedder Loop tip only

# Mouth & Throat Instruments

Snare Wires  
Snare Drähte  
Cables de la caja  
Fils de piège  
Fili Snare

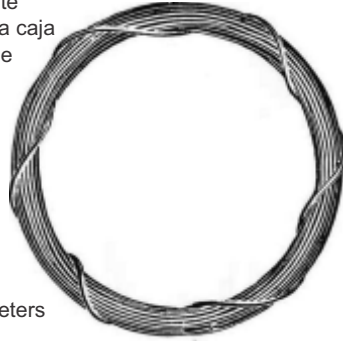

Coil/10 meters

For Tonsil Snares

TS.14.01.23 Ø 0.35 mm  
TS.14.01.24 Ø 0.40 mm  
TS.14.01.25 Ø 0.45 mm

Standard size Delivery with 3 wires, pre shaped

Delivery with 3 wire loops

with catch



EVES  
TS.14.02.27  
27 cm/ 10¾"

with catch



BRUNING  
TS.14.02.29  
29 cm/ 11½"



EVES  
TS.14.02.37  
27 cm/ 10¾"

Tonsil Artery Forceps

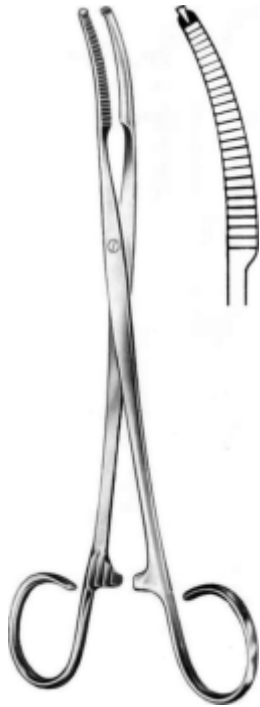

MIKULICZ  
TS.14.04.18  
18 cm / 7 $\frac{1}{8}$ "

Tonsil Seizing Forceps



MARSHIK  
TS.14.04.22  
22 cm / 8 $\frac{3}{4}$ "



WHITE  
TS.14.04.23  
23 cm / 9"

# Mouth & Throat Instruments



WHITE  
TS.14.05.19  
18 cm / 7 $\frac{1}{8}$ "



COLVER  
TS.14.06.19  
19 cm / 7 $\frac{1}{2}$ "



ABRAHAM  
TS.14.06.22  
20.5 cm / 8 $\frac{1}{8}$ "

Delivery with 3 wires, pre shaped



LEWIS  
TS.14.02.45  
25.5 cm/ 8 $\frac{1}{8}$ "

For catgut loops



ROEDER "E"  
TS.14.02.47  
27 cm/ 10 $\frac{3}{4}$ "

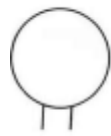

TS.14.03.13  
Ø 13 mm

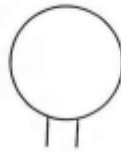

TS.14.03.15  
Ø 15 mm

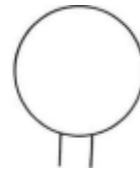

TS.14.03.17  
Ø 17 mm

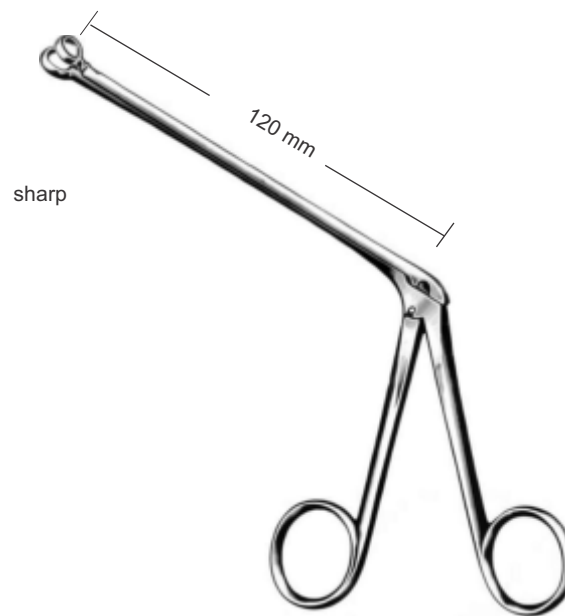

HARTMANN

# Mouth & Throat Instruments



Clamping forceps

TS.14.07.21  
 19 cm/ 7½"  
 # 1

NEGUS



Ligature clamp

TS.14.07.22  
 19 cm/ 7½"  
 # 2

NEGUS



MUCK  
 18 cm/ 7¼"



TS.14.07.31  
 # 1 - 8 mm



TS.14.07.32  
 # 2 - 10 mm



MCWORTHER-LOTHROP  
 TS.14.07.38  
 18.5 cm/ 7¼"



# Mouth & Throat Instruments



BLOHMKE  
TS.14.09.20  
21 cm/ 8¼"



THILENIUS  
TS.14.09.30  
20 cm/ 8"



TS.14.11.18  
18 cm/ 7 $\frac{1}{8}$ "

CANFIELD  
TS.14.11.19  
21 cm/ 8 $\frac{1}{4}$ "

ABRAHAM  
TS.14.12.20  
21 cm/ 8 $\frac{1}{4}$ "

BRUNINGS  
TS.14.12.23  
23 cm/ 9"

DAY  
TS.14.12.40  
20 cm/ 8"

# Mouth & Throat Instruments



Reversible, in screwable sheath



FISHER  
TS.14.13.20  
22.5 cm/ 9"

ABRAHAM(TYDING)  
TS.14.13.30  
20 cm/ 8"

TS.14.14.21  
21 cm/ 8¼"  
Ø 7 mm

TS.14.14.22  
10 cm/ 4"  
Ø 4 mm

Tonsil Gauze Packer



LUNIATSCHECK  
TS.14.21.18  
18 cm / 7 $\frac{1}{8}$ "

# Mouth & Throat Instruments

1 Serrated blade

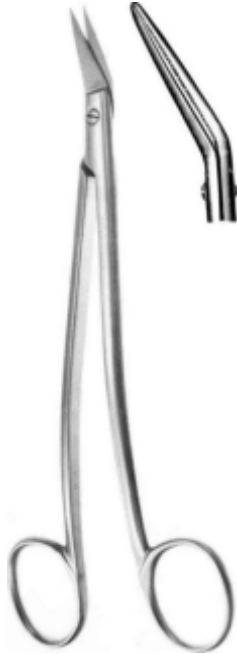

DEAN  
TS.14.25.17  
17 cm/ 6¾"



BOETTCHER  
TS.14.25.18  
18 cm/ 7¼"



PRINCE  
TS.14.25.23  
18 cm/ 7¼"



GOOD  
TS.14.25.30  
19 cm/ 7½"

# Mouth & Throat Instruments

Elevator

Elevator



**YANKAUER**  
 TS.14.15.22  
 21 cm/ 8¼"



TS.14.17.22  
 6 + 12 mm



**HURD**  
 22 cm/ 8¾"



TS.14.16.22  
 10 + 12 mm



**ALDERDICE**  
 TS.14.18.21  
 22 cm/ 8¾"



**HENKE**  
 TS.14.19.12  
 24 cm/ 9½"  
 12 + 18 mm

Tonsil Dissector with suction device

Enucleator

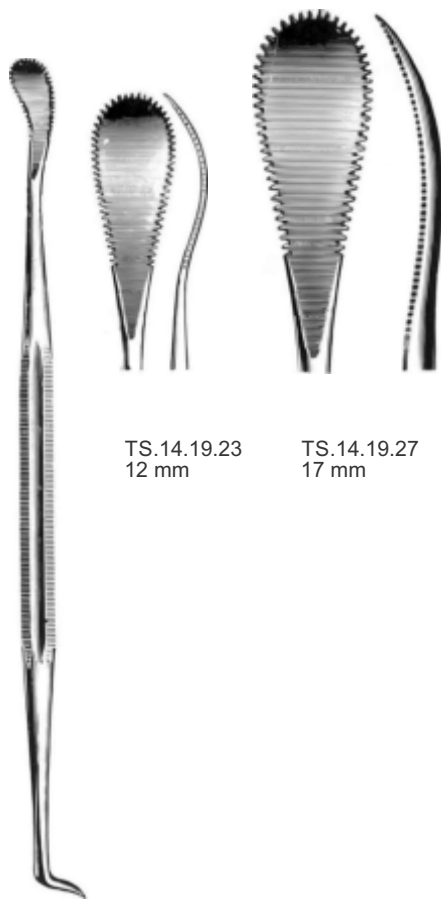

TS.14.19.23  
12 mm

TS.14.19.27  
17 mm

HENKE  
23 cm/ 9"

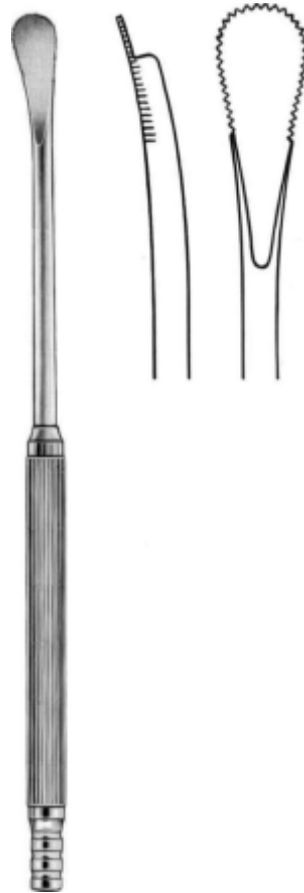

LOPEZ-REINKE  
TS.14.20.23  
23 cm/ 9"



CARPENTER  
TS.14.20.25  
25 cm/ 10"



TS.14.27.05  
Handle only

SLUDER-BALLENGER  
TS.14.27.00

Working shaft and blades in angled-up position to the handle, complete, with 1 blade each fig, 1, 2 and 3

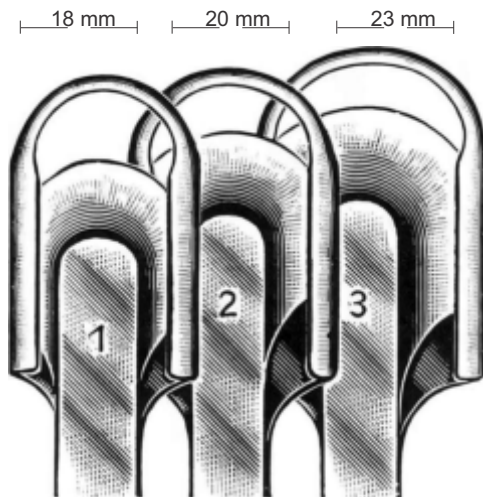

Blades only

TS.14.27.01  
#1

TS.14.27.02  
#2

TS.14.27.03  
#3

SLUDER-BALLENGER



# Mouth & Throat Instruments

Rhinoscopic mirrors, movable



Without handle



Shaft 12 cm long (4 3/4")

With adjusting screw



TS.14.01.50  
11 cm / 4 3/4"

With chuck



TS.14.02.55  
11.5 cm / 4 1/2"



22 cm / 8 1/4"



TS.14.03.52



TS.14.03.54



TS.14.03.56



TS.14.03.58

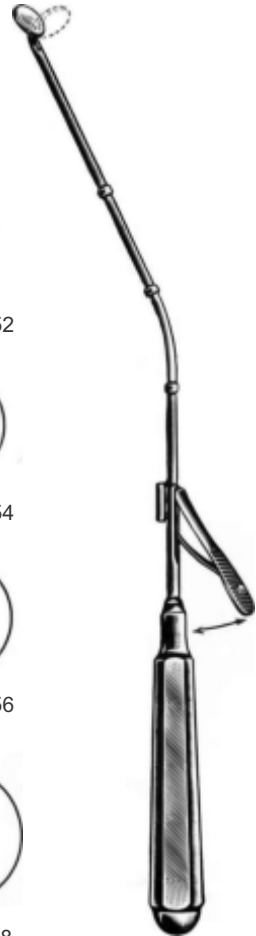

MICHEL  
27 cm / 10 3/4"

- TS.14.01.06 fig. 000 - Ø 6 mm
- TS.14.01.08 fig. 00 - Ø 8 mm
- TS.14.01.10 fig. 0 - Ø 10 mm
- TS.14.01.12 fig. 1 - Ø 12 mm
- TS.14.01.14 fig. 2 - Ø 14 mm
- TS.14.01.16 fig. 3 - Ø 16 mm
- TS.14.01.18 fig. 4 - Ø 18 mm
- TS.14.01.20 fig. 5 - Ø 20 mm
- TS.14.01.22 fig. 6 - Ø 22 mm
- TS.14.01.24 fig. 7 - Ø 24 mm
- TS.14.01.26 fig. 8 - Ø 26 mm
- TS.14.01.28 fig. 9 - Ø 28 mm
- TS.14.01.30 fig. 10 - Ø 30 mm

- TS.14.03.06 fig. 000 - Ø 6 mm
- TS.14.03.08 fig. 00 - Ø 8 mm
- TS.14.03.10 fig. 0 - Ø 10 mm
- TS.14.03.12 fig. 1 - Ø 12 mm
- TS.14.03.14 fig. 2 - Ø 14 mm
- TS.14.03.16 fig. 3 - Ø 16 mm
- TS.14.03.18 fig. 4 - Ø 18 mm
- TS.14.03.20 fig. 5 - Ø 20 mm
- TS.14.03.22 fig. 6 - Ø 22 mm
- TS.14.03.24 fig. 7 - Ø 24 mm
- TS.14.03.26 fig. 8 - Ø 26 mm
- TS.14.03.28 fig. 9 - Ø 28 mm
- TS.14.03.30 fig. 10 - Ø 30 mm

Shaft 10 cm long (4")

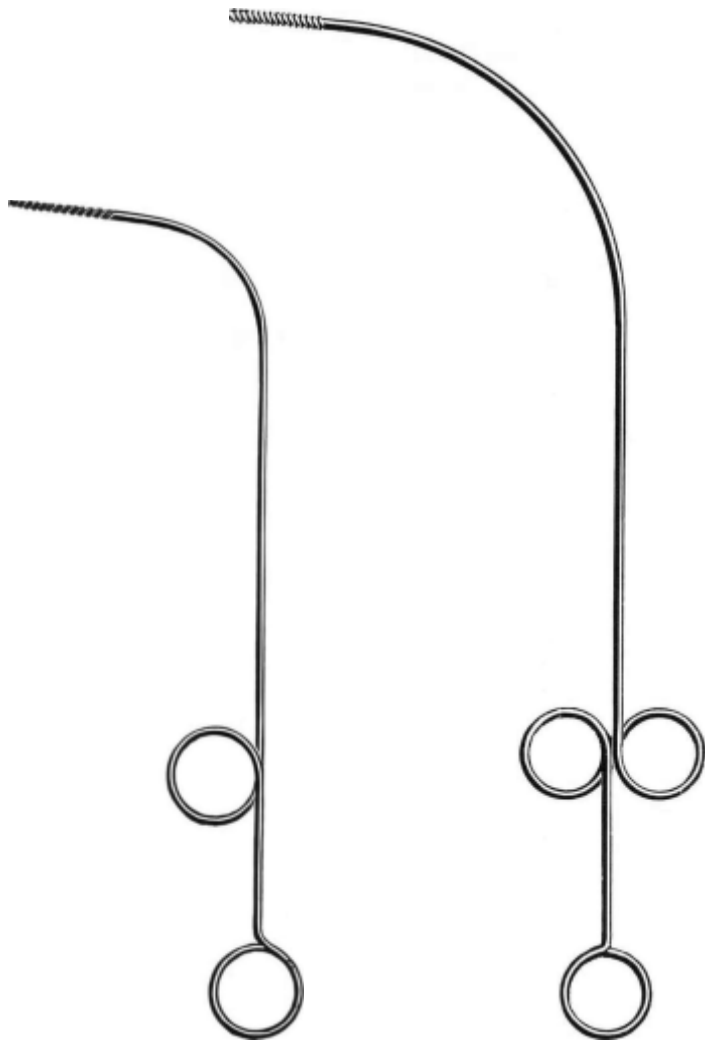

PELTSESON  
TS.14.04.30  
23.5 cm/ 9¼"

FEIN  
TS.14.04.35  
29 cm/ 11¾"



REICHERT  
TS.14.04.45  
23 cm/ 9"

# Mouth & Throat Instruments



HARTMANN  
TS.14.04.52  
20.5 cm/ 8 $\frac{1}{8}$ "



SAWTEL (TOBOLD)  
TS.14.04.60  
30 cm/ 11 $\frac{3}{4}$ "



KILLIAN  
TS.14.04.65  
25 cm/ 10"

# Mouth & Throat Instruments



TS.14.05.11  
 TS.14.05.31  
 # 1 - 10mm



TS.14.05.12  
 TS.14.05.32  
 # 2 - 11mm



TS.14.05.13  
 TS.14.05.33  
 # 3 - 12mm



TS.14.05.14  
 TS.14.05.34  
 # 4 - 13mm



TS.14.05.15  
 TS.14.05.35  
 # 5 - 15mm



TS.14.05.16  
 TS.14.05.36  
 # 6 - 16mm

with basket



BECKMANN  
 TS.14.05.11 # 1  
 TS.14.05.12 # 2  
 TS.14.05.13 # 3  
 TS.14.05.14 # 4  
 TS.14.05.15 # 5  
 TS.14.05.16 # 6  
 22 cm / 8<sup>3</sup>/<sub>4</sub>"

BECKMANN  
 TS.14.05.31 # 1  
 TS.14.05.32 # 2  
 TS.14.05.33 # 3  
 TS.14.05.34 # 4  
 TS.14.05.35 # 5  
 TS.14.05.36 # 6  
 22 cm / 8<sup>3</sup>/<sub>4</sub>"

# Mouth & Throat Instruments



SHAMBAUGH  
(NEGUS)  
TS.14.05.40 # 0  
TS.14.05.41 # 1  
TS.14.05.42 # 2  
TS.14.05.44 # 3  
TS.14.05.46 # 4  
TS.14.05.48 # 5  
22 cm/ 8¾"



TS.14.05.40 - 10 mm  
TS.14.05.60 - 14 mm  
# 0



TS.14.05.41 - 11 mm  
TS.14.05.61 - 16 mm  
# 1

with basket



TS.14.05.42 - 12 mm  
TS.14.05.62 - 18 mm  
# 2



TS.14.05.44 - 14 mm  
TS.14.05.64 - 20 mm  
# 3



TS.14.05.46 - 16 mm  
TS.14.05.66 - 22 mm  
# 4



TS.14.05.48 - 18 mm  
TS.14.05.68 - 24 mm  
# 5

Curved backward

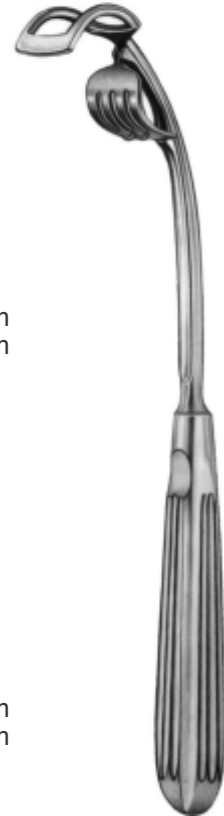

SHAMBAUGH  
(NEGUS)  
TS.14.05.60 # 0  
TS.14.05.61 # 1  
TS.14.05.62 # 2  
TS.14.05.64 # 3  
TS.14.05.66 # 4  
TS.14.05.68 # 5  
21 cm/ 8¼"

Included in the consignment: 3 blades of the each size



**LA FORCE-MEDICON**  
 TS.14.06.10 # 0  
 TS.14.06.11 # 1  
 TS.14.06.12 # 2  
 TS.14.06.13 # 3  
 23.5 cm/ 9¼"



**SHAMBAUGH**  
 TS.14.06.50 # 0  
 TS.14.06.51 # 1  
 TS.14.06.52 # 2  
 TS.14.06.53 # 3  
 23.5 cm/ 9¼"

Replacement blades only for la  
 force and shambaugh adenotome

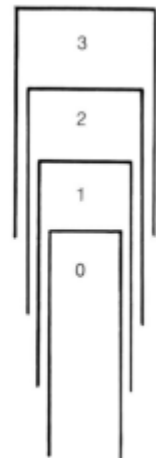

TS.14.06.90 # 0 - 10 mm  
 TS.14.06.91 # 1 - 13 mm  
 TS.14.06.92 # 2 - 16 mm  
 TS.14.06.93 # 3 - 19 mm

# Mouth & Throat Instruments

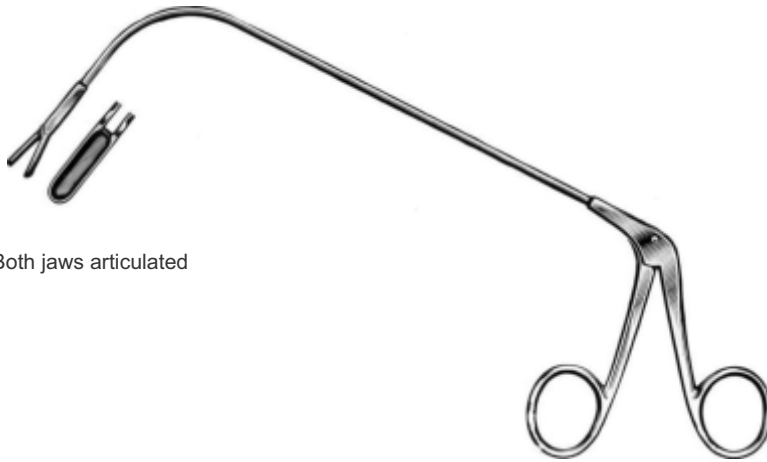

Both jaws articulated

FRANKEL  
TS.14.07.17

Working length 17 cm (6 ¾")

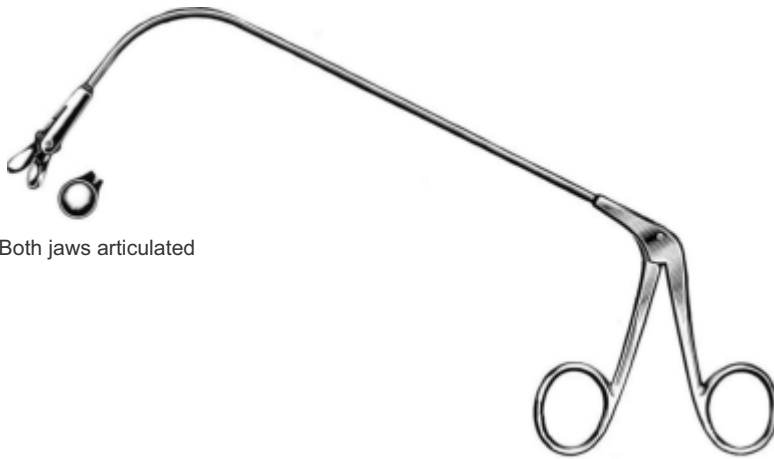

Both jaws articulated

LANGE  
TS.14.08.17

Working length 17 cm (6 ¾")

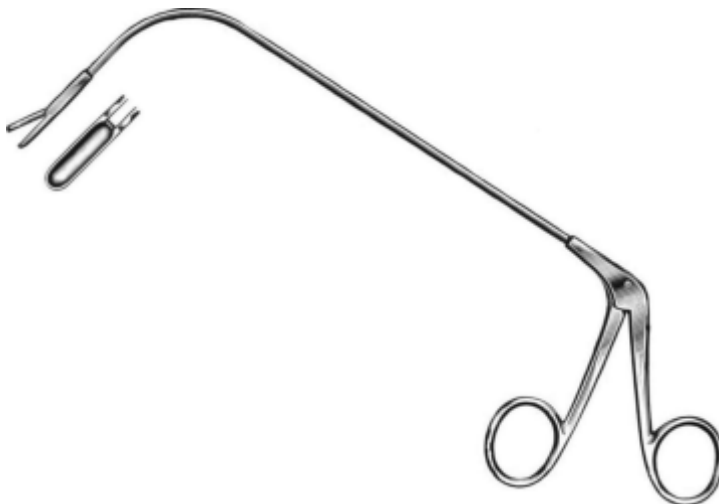

JURASZ  
TS.14.10.24  
TS.14.10.25  
TS.14.10.26  
TS.14.10.27

Working length 17 cm (6 ¾")

TS.14.10.26  
Opening upward

TS.14.10.27  
opening downward

TS.14.10.24  
Opening right

TS.14.10.25  
Opening left



sharp

ST. CLAIR-THOMSON  
TS.14.09.38  
18 cm / 7 1/8"



for children

sharp

JURASZ  
TS.14.09.39  
19 cm / 7 1/2"

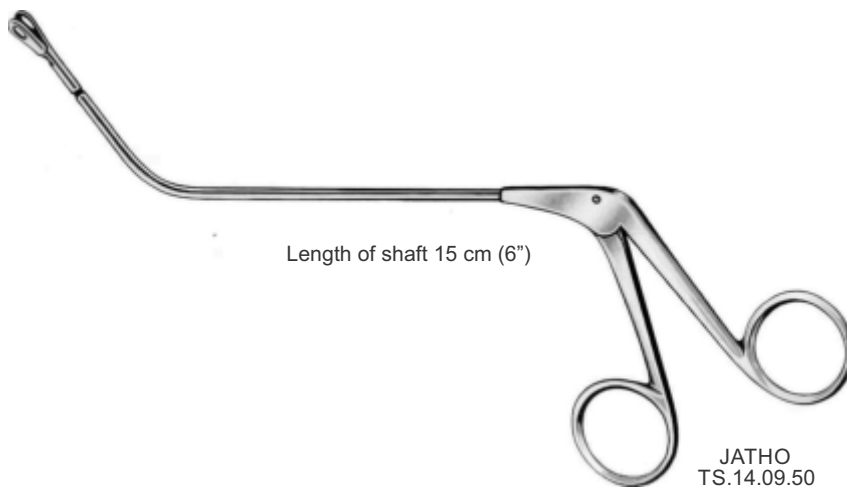

Length of shaft 15 cm (6")

JATHO  
TS.14.09.50



# Mouth & Throat Instruments



Micro laryngeal surgery

Shaft 2 mmø



TS.14.10.31  
serrated jaws, straight



TS.14.10.32  
serrated jaws right



TS.14.10.36  
round cup jaws, straight



TS.14.10.41  
serrated jaws left



TS.14.10.33  
round cup jaws, up



TS.14.10.37  
round cup jaws, left



TS.14.10.42  
round cup jaws, right



TS.14.10.34  
oval cup jaws, straight



TS.14.10.38  
oval cup jaws, right



TS.14.10.43  
oval cup jaws, up



TS.14.10.35  
oval cup jaws, left



TS.14.10.39  
jaw fenestrated



TS.14.10.44  
oval cup jaws, straight

# Mouth & Throat Instruments



TS.14.10.50  
straight



TS.14.10.51  
angled up



TS.14.10.52  
Curved to right



TS.14.10.53  
curved to left



TS.14.10.54  
angled down



TS.14.10.55  
straight, horizontally cutting

Flexible working end

Naso-Pharyngeal Forceps



TS.14.10.32  
# R  
Jaws opening to the right



TS.14.10.33  
# L  
Jaws opening to the left



TS.14.10.32 # R  
TS.14.10.33 # L

# Mouth & Throat Instruments

## Uvule retractors



LOVE  
15 cm/ 6"  
TS.14.10.48 18 mm  
TS.14.10.50 20mm  
TS.14.10.52 22 mm

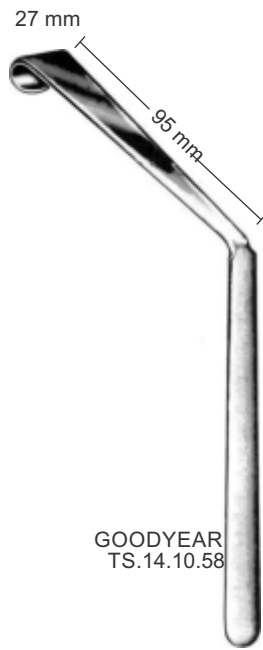

GOODYEAR  
TS.14.10.58



LOTHROP  
TS.14.10.60

## 13 mm soft palate retractor

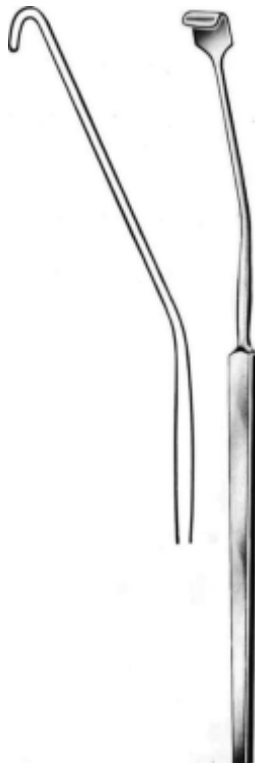

NAGER  
TS.14.10.72  
22 cm/ 8¾"

## 20 x 20 mm palate arch retractor



HOFER  
TS.14.10.74  
24 cm/ 9½"

Elongation tubes      rigid      angled

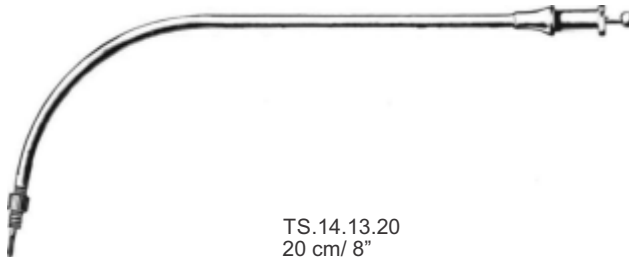
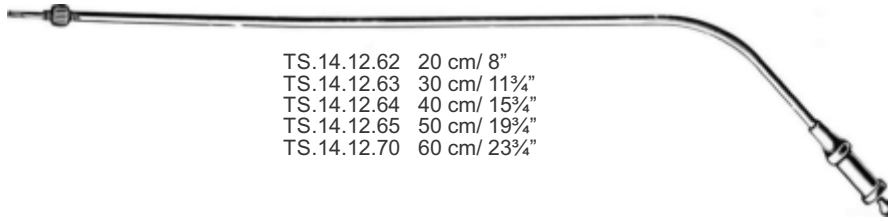

Elongation tubes      curved

# Mouth & Throat Instruments

Laryngeal forceps tips (suitable for elongation tubes)



FRANKEL  
TS.14.14.05



FRANKEL  
TS.14.15.03



FRANKEL  
TS.14.16.01



BRUNINGS  
TS.14.14.13 Ø 3 mm  
TS.14.14.14 Ø 4 mm



EICKEN  
TS.14.15.08



SEIFFERT  
TS.14.16.06



FRANKEL  
TS.14.14.20



BRUNINGS  
TS.14.15.13 Ø 3 mm  
TS.14.15.14 Ø 4 mm



LANGE  
TS.14.16.15



KRAUSE  
TS.14.14.31



SCHEINMANN  
TS.14.15.27



BRUNINGS  
TS.14.16.22 2.5 X 5 mm  
TS.14.16.23 3 X 6 mm



SCHEINMANN  
TS.14.14.37



KRAUSE  
TS.14.15.35



KRAUSE  
TS.14.16.34



SCHUMACHER  
TS.14.16.40



JACKSON  
TS. 14.10.68  
18.5 cm / 7¼"

Laryngeal Forceps

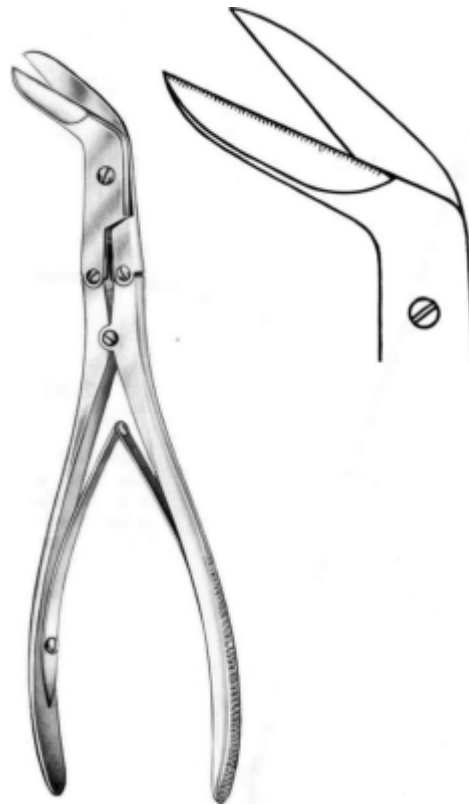

KILLIAN  
TS. 14.10.70  
20 cm / 8"

Laryngectomy scissors



Medicon Universal handle for elongation tubes

MEDICON-UNIVERSAL  
TS.14.11.45

Elongation tubes      rigid      straight



TS.14.12.20 20 cm/ 8"  
TS.14.12.30 30 cm/ 11 $\frac{3}{4}$ "  
TS.14.12.40 40 cm/ 15 $\frac{3}{4}$ "  
TS.14.12.50 50 cm/ 19 $\frac{3}{4}$ "  
TS.14.12.60 60 cm/ 23 $\frac{3}{4}$ "

Laryngeal forceps tips (suitable for elongation tubes)



**CORDES (ROSENBERG)**  
TS.14.17.61 # 1-3 mm  
TS.14.17.62 # 2-4 mm  
TS.14.17.63 # 3-5 mm



**CORDES**  
TS.14.18.51  
Ø 4 mm



**CORDES**  
TS.14.19.50  
Ø 4 mm



**CORDES**  
TS.14.17.71 # 1  
TS.14.17.72 # 2



**CORDES**  
TS.14.18.70  
5 mm

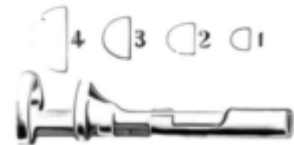

**CORDES**  
TS.14.19.61 # 1-3 mm  
TS.14.19.62 # 2-4 mm  
TS.14.19.63 # 3-5 mm  
TS.14.19.64 # 4-8 mm



**CORDES**  
TS.14.19.76



**EICKEN**  
TS.14.17.78



**SEIFFERT**  
TS.14.18.76



**FRANKEL**  
TS.14.19.81



**BRUNINGS**  
TS.14.17.82 2.5 X 5 mm  
TS.14.17.83 3 X 6 mm



**FRANKEL**  
TS.14.18.80



**BRUNINGS**  
TS.14.19.83 Ø 3 mm  
TS.14.19.84 Ø 4 mm



**KRAUSE**  
TS.14.18.84  
TS.14.18.85



**SCHEINMANN**  
TS.14.19.97



# Mouth & Throat Instruments

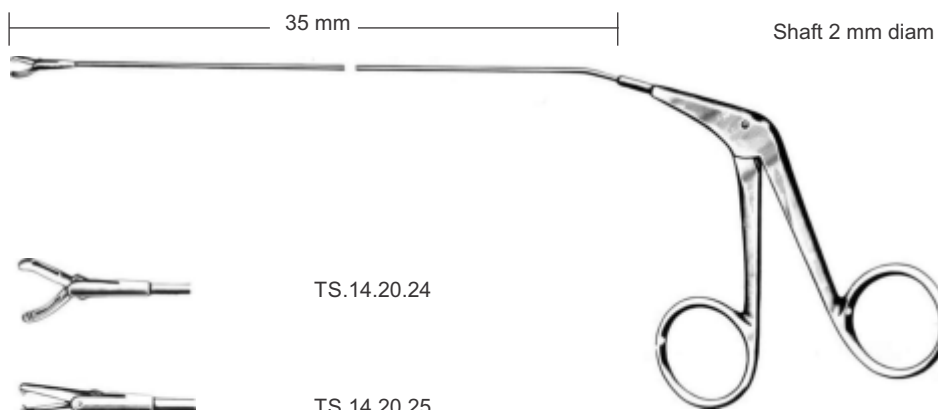
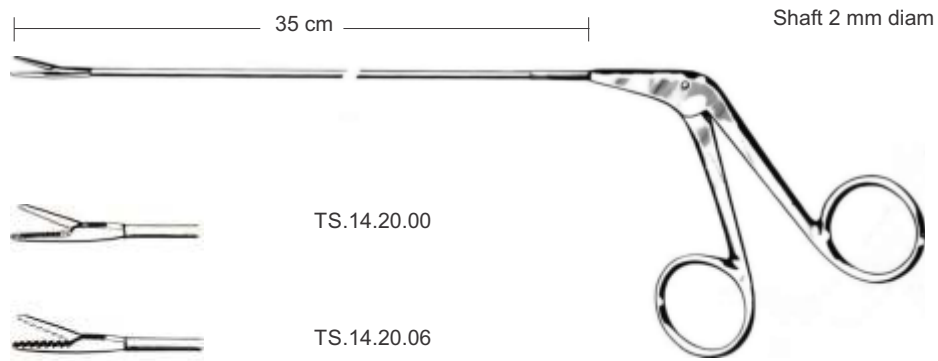

MEDICON-JACKSON  
Delicate pattern

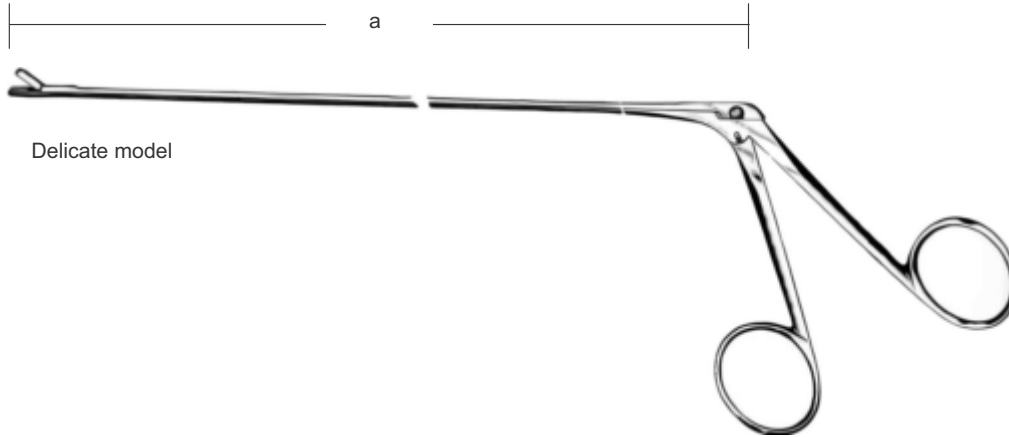

Delicate model

			Ø 2 mm	Ø 2 mm
a				
28 cm	TS.14.21.04	TS.14.21.12	TS.14.21.17	
35 cm	TS.14.22.04	TS.14.22.12	TS.14.22.17	

	PATTERSON		
a			
28 cm	TS.14.23.20	TS.14.23.31	TS.14.23.35
35 cm	TS.14.24.20	TS.14.24.31	TS.14.24.35

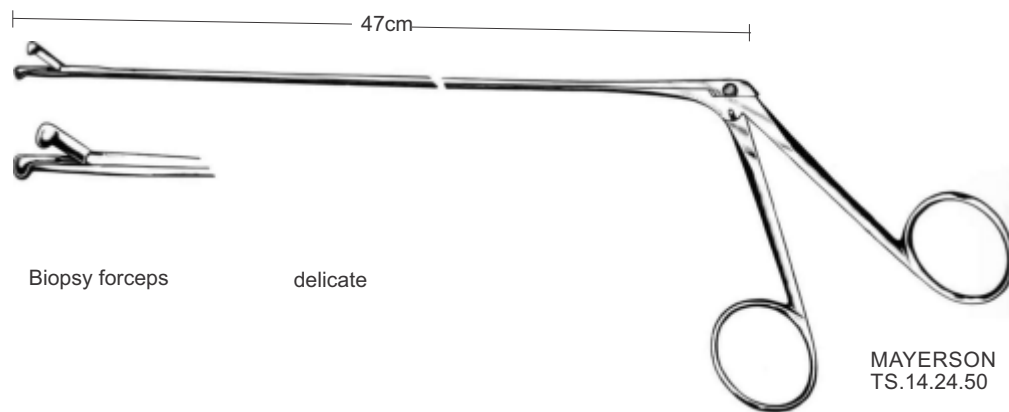

Biopsy forceps

delicate



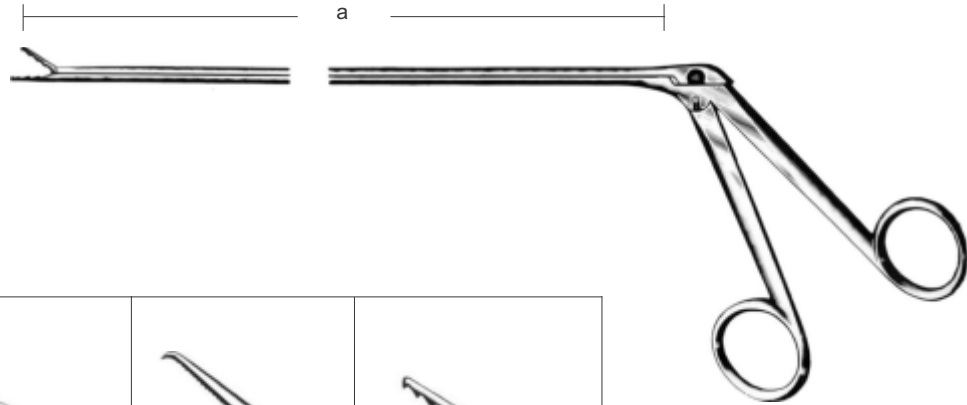

MAYERSON  
TS.14.24.50



# Mouth & Throat Instruments



JACKSON



a			
30 cm	TS.15.25.04	TS.15.25.05	TS.15.25.06
40 cm	TS.15.26.04	TS.15.26.05	TS.15.26.06
50 cm	TS.15.27.04	TS.15.27.05	TS.15.27.06
60 cm	TS.15.28.04	TS.15.28.05	TS.15.28.06

a	 Ø 2 mm	 Ø 4 mm	 Ø 2 mm	 Ø 4 mm
30 cm	TS.15.30.12	TS.15.30.14	TS.15.30.17	TS.15.30.19
40 cm	TS.15.31.12	TS.15.31.14	TS.15.31.17	TS.15.31.19
50 cm	TS.15.32.12	TS.15.32.14	TS.15.32.17	TS.15.32.19
60 cm	TS.15.33.12	TS.15.33.14	TS.15.33.17	TS.15.33.19

a	 11 x 4 mm PATTERSON		
30 cm	TS.15.35.20	TS.15.35.31	TS.15.35.35
40 cm	TS.15.36.20	TS.15.36.31	TS.15.36.35
50 cm	TS.15.37.20	TS.15.37.31	TS.15.37.35
60 cm	TS.15.38.20	TS.15.38.31	TS.15.38.35

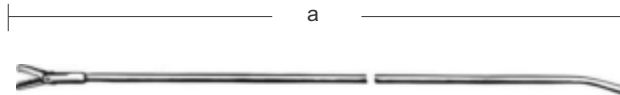
# Mouth & Throat Instruments





a		
35 cm	TS.15.40.06	TS.15.40.08
45 cm	TS.15.41.06	TS.15.41.08
55 cm	TS.15.42.06	TS.15.42.08



MEDICON JACKSON

Shaft 3mm diam, for use through tubes up from 6 mm diam

a		
35 cm	TS.15.45.25	TS.15.45.28
45 cm	TS.15.46.25	TS.15.46.28
55 cm	TS.15.47.25	TS.15.47.28

a		
35 cm	TS.15.50.31	TS.15.50.35
45 cm	TS.15.51.31	TS.15.51.35
55 cm	TS.15.52.31	TS.15.52.35

a	
35 cm	TS.15.55.45
45 cm	TS.15.56.45
55 cm	TS.15.57.45

# Mouth & Throat Instruments

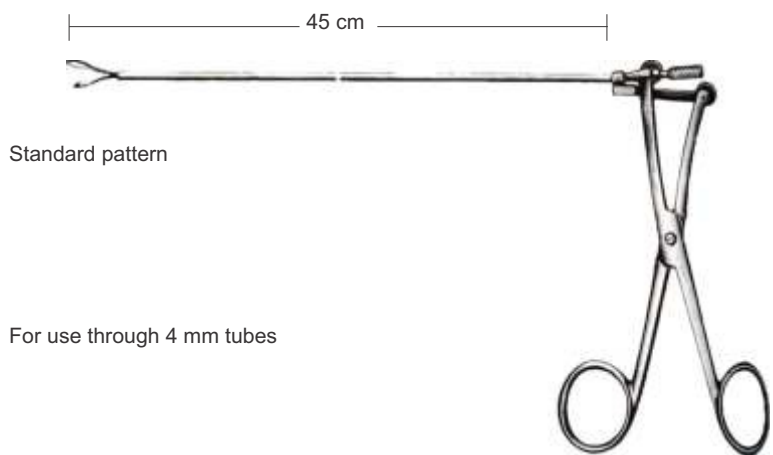
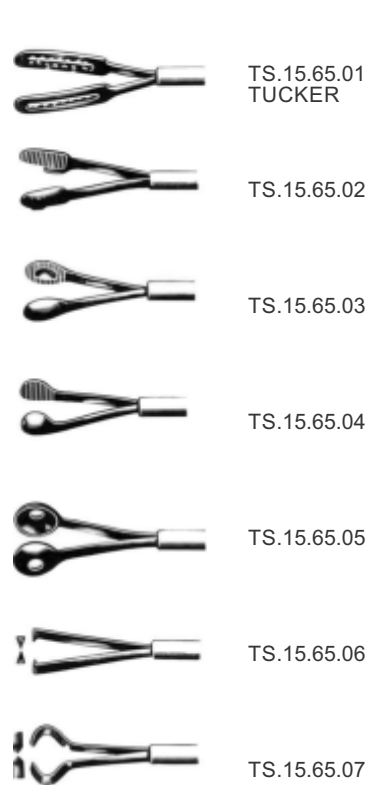
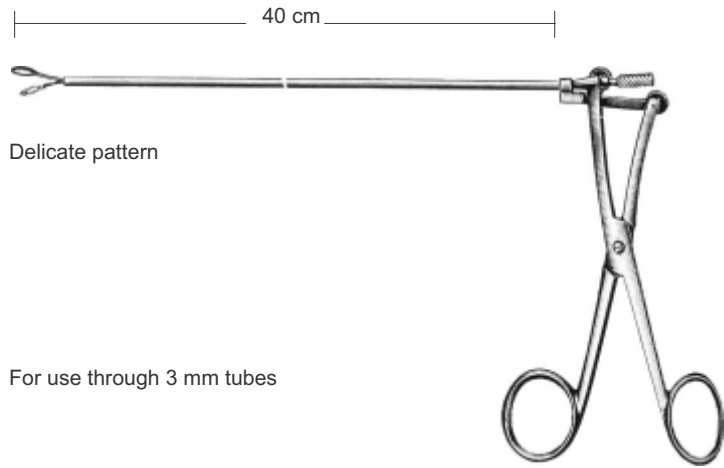
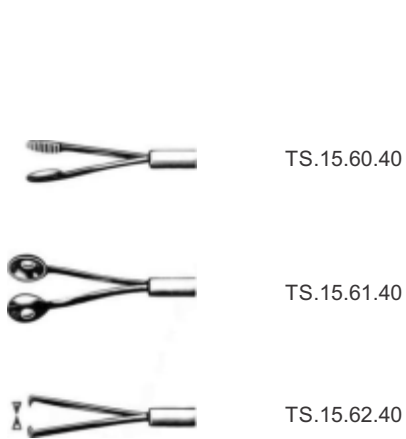

German silver

Silver plated



### CHEVALIER-JACKSON

TS.15.33.50	Fig. 0 - 4 mm Ø	TS.15.33.60
TS.15.33.51	Fig. 1 - 5 mm Ø	TS.15.33.61
TS.15.33.52	Fig. 2 - 6 mm Ø	TS.15.33.62
TS.15.33.53	Fig. 3 - 7 mm Ø	TS.15.33.63
TS.15.33.54	Fig. 4 - 8 mm Ø	TS.15.33.64
TS.15.33.55	Fig. 5 - 9 mm Ø	TS.15.33.65
TS.15.33.56	Fig. 6 - 10 mm Ø	TS.15.33.66
TS.15.33.57	Fig. 7 - 11 mm Ø	TS.15.33.67
TS.15.33.58	Fig. 8 - 12 mm Ø	TS.15.33.68
TS.15.33.59	Fig. 9 - 13 mm Ø	TS.15.33.69

Speaking tube

Silver plated



### LUER











TS.15.34.08	Fig. 4 - 8 mm Ø
TS.15.34.09	Fig. 5 - 9 mm Ø
TS.15.34.10	Fig. 6 - 10 mm Ø
TS.15.34.11	Fig. 7 - 11 mm Ø
TS.15.34.12	Fig. 8 - 12 mm Ø
TS.15.34.13	Fig. 9 - 13 mm Ø

Cleaning brush for tracheal tubes

TS.15.34.20  
 19.5 cm / 7¾"  
 Ø 11 mm



## International scale of tracheal tube sizes

										
Fig.	0	1	2	3	4	5	6	7	8	9
mm Ø	4	5	6	7	8	9	10	11	12	13
Charr.	12	15	18	21	24	27	30	33	36	39
Length mm	45	50	55	60	65	70	75	80	85	90

Tracheal tube, standard pattern



German silver

LUER

Silver plated

TS.15.33.80	Fig. 0 - 4 mm Ø	TS.15.33.90
TS.15.33.81	Fig. 1 - 5 mm Ø	TS.15.33.91
TS.15.33.82	Fig. 2 - 6 mm Ø	TS.15.33.92
TS.15.33.83	Fig. 3 - 7 mm Ø	TS.15.33.93
TS.15.33.84	Fig. 4 - 8 mm Ø	TS.15.33.94
TS.15.33.85	Fig. 5 - 9 mm Ø	TS.15.33.95
TS.15.33.86	Fig. 6 - 10 mm Ø	TS.15.33.96
TS.15.33.87	Fig. 7 - 11 mm Ø	TS.15.33.97
TS.15.33.88	Fig. 8 - 12 mm Ø	TS.15.33.98
TS.15.33.89	Fig. 9 - 13 mm Ø	TS.15.33.99



BOSE  
TS.15.37.07  
7 cm / 2¾"

## Tracheal dilators



TROUSSEAU  
TS.15.36.12  
12 cm / 4¾"

for children

TROUSSEAU  
TS.15.36.14  
14 cm / 5½"

for adults

## Tracheal artery forceps



JACKSON  
TS.15.36.15  
14.5 cm / 5¾"

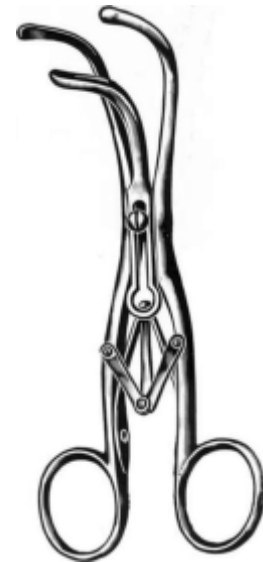

LABORDE  
TS.15.37.15  
15 cm / 6"

for adults

LABORDE  
TS.15.37.13  
13 cm / 5½"

for children



## Tracheal retractors



BOSE  
TS.15.37.32  
16 cm/ 6¼"



BOSE  
TS.15.37.33  
16 cm/ 6¼"



TS.15.37.45  
16 cm/ 6¼"  
Ø 3 mm  
for infants

## Tracheotomy trocars



UECKERMANN-  
DENKER  
TS.15.37.50  
Ø 10 mm  
13 cm/ 5⅛"  
Sterling silver

## Tracheotomy knife



JACKSON  
TS.15.41.16  
17 cm/ 6¾"

# Mouth & Throat Instruments



JACKSON  
 TS.15.38.13  
 13 cm/ 5½"



LUCKENS  
 TS.15.39.13

Thyroid dissector

10mm  
 wide



KOCHER  
 TS.15.43.15  
 15 cm/ 6"

12mm  
 wide

Thyroid dissecting scissors



KOCHER  
 TS.15.43.16  
 16.5 cm/ 6½"

SCHOEMAKER  
 TS.15.43.25  
 15 cm/ 6"

Goiter forceps



LOVELACE  
 TS.15.43.35  
 15 cm/ 6"

sharp



LAHEY  
 TS.15.43.45  
 15 cm/ 6"

sharp

# Mouth & Throat Instruments

Automatic adjusting ratchet

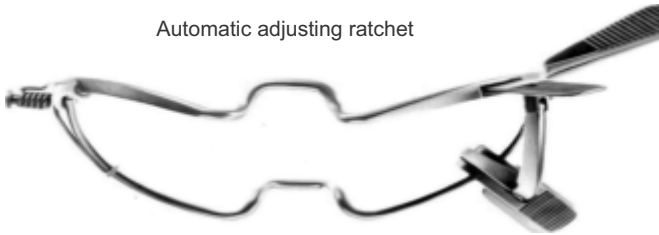

FIMZ  
TS.15.01.49 9 cm/ 3½"  
TS.15.01.51 11 cm/ 4¼"  
TS.15.01.53 13 cm/ 5⅛"  
TS.15.01.55 15 cm/ 6"

SEEMANN-SEIFFERT  
TS.15.02.61 11 cm/ 4¼"  
TS.15.02.63 13 cm/ 5⅛"

Dimensions = effective width



JENNINGS  
FIMZ  
TS.15.03.30

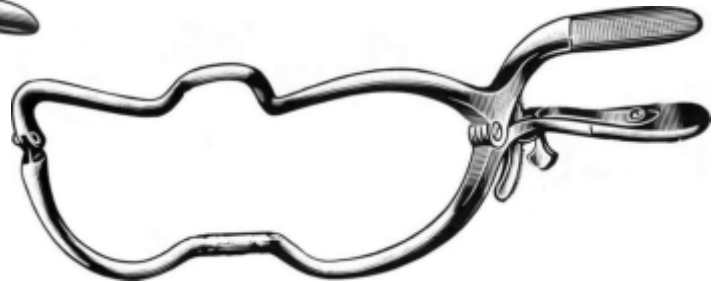

JENNINGS  
TS.15.09.09 9 cm/ 3½"  
TS.15.09.11 11 cm/ 4¼"  
TS.15.09.13 13 cm/ 5⅛"  
TS.15.09.15 15 cm/ 6"



WHITEHEAD  
TS.15.11.29 9 cm/ 3½"  
TS.15.11.31 11 cm/ 4¼"  
TS.15.11.33 13 cm/ 5⅛"  
TS.15.11.35 15 cm/ 6"

## Mouth gags

of wood



TS.15.04.10  
Ø 40 mm

of hard rubber



TS.15.04.20  
Ø 40 mm



HEISTER  
TS.15.05.05  
13 cm/ 5 1/8"

for children



MOLT  
TS.15.06.10  
10 cm/ 4"

for adults



MOLT  
TS.15.07.15  
15 cm/ 6"

Soft metal coated



DOYEN-JANSEN  
TS.15.08.20 10 cm/ 4"  
TS.15.08.25 15 cm/ 6"

TS.15.08.20  
for children

TS.15.08.25  
for adults



ROSER KÖNIG  
TS.15.13.45  
16 cm/ 6 1/4"

# Mouth & Throat Instruments



Mouth openers

OBWEGESER-ROSER  
TS.15.13.46  
16 cm/ 6¼"



OBWEGESER  
TS.15.13.53  
12.5 cm/ 5"



DENHART  
TS.15.14.60  
13 cm/ 5½"



FERGUSSON-ACKLAND  
TS.15.15.70  
20 cm/ 8"



TS.15.16.80  
for children

TS.15.16.81  
for adults

MASON-ACKLAND  
TS.15.16.80 14 cm/ 5½"  
TS.15.16.81 20 cm/ 8"

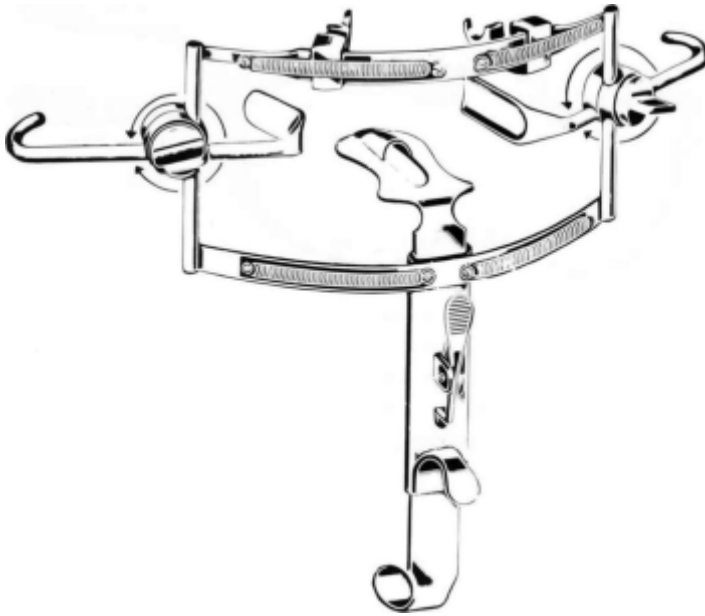

DINGMAN  
TS.15.18.00



TS.15.18.11  
# 1  
55 x 25 mm



TS.15.18.12  
# 2  
60 x 27 mm



TS.15.18.13  
# 3  
70 x 30 mm

TS.15.18.00

Dingman mouth gag, complete consisting of: frame with 2 tooth hooks, 2 lateral cheek retractors and 3 Tongue depressors (1 each figures 1 to 3 )

-----  
Frame only for the DINGMAN mouth gag, with 4 spiral spring for the suspension of the thread ends, 2 movable tooth hooks and 2 movable cheek retractors

# Mouth & Throat Instruments

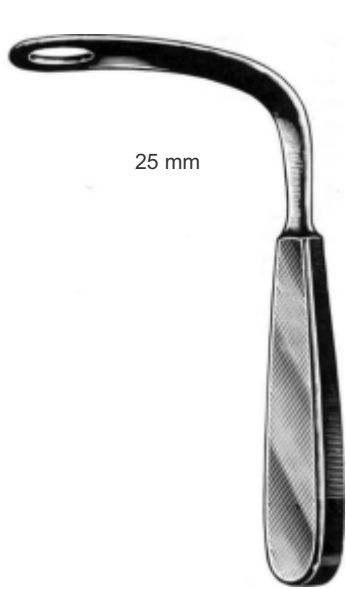

25 mm

BOSWORTH  
TS.15.01.20



80mm

25 mm

TOBOLD  
TS.15.01.14

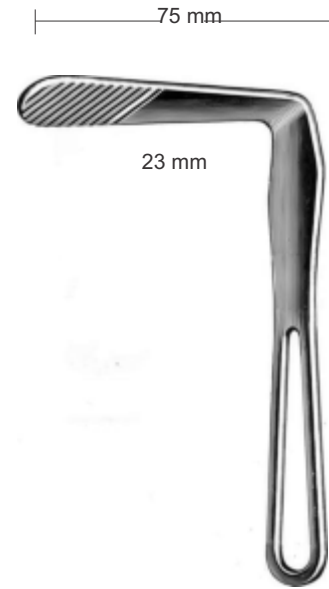

75 mm

23 mm

HARTMANN  
TS.15.02.15

## Tongue Depressors



85 mm

ANDREWS  
TS.15.02.30



80 mm

WIEDER

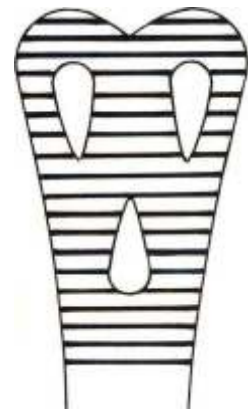

TS.15.02.21  
28 mm

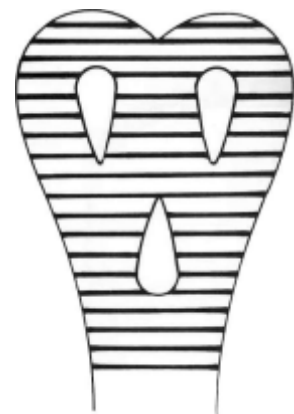

TS.15.02.22  
38 mm

18 mm



TS.15.03.12  
14.5 cm / 5¾"

20 mm



TS.15.03.14  
14 cm / 5½"

23 mm



STERNBERG  
TS.15.03.15  
14.5 cm / 5¾"

wood



Package unit 100 pieces

TS.15.03.16  
16 cm / 6¼"

18 mm



BAGINSKI  
TS.15.03.25  
15 cm / 6"

35 mm

Tongue Depressors



UNIV. MINNESOTA  
TS.15.03.34  
14 cm / 5½"

23 mm



13 mm

FRENZEL  
TS.15.03.35  
16.5 cm / 6½"

18 mm



23 mm

BUCHWALD  
TS.15.04.18  
18 cm / 7⅛"



# Mouth & Throat Instruments



TS.15.04.22 22+29 mm  
TS.15.04.26 30+33 mm

HASLINGER  
TS.15.04.22 12 cm/ 4¾"  
TS.15.04.26 16 cm/ 6¼"



18 mm

14 mm

BRUNINGS  
TS.15.05.18  
19 cm/ 7½"



MORITZ-SCHMIDT  
TS.15.05.19  
19 cm/ 7½"



TS.15.06.21  
#1, Ø 17 - 21 mm



TS.15.06.24  
#2, Ø 19 - 24 mm



TS.15.06.26  
#3, Ø 21 - 26 mm



Nasal Instruments

# Nasal Instruments

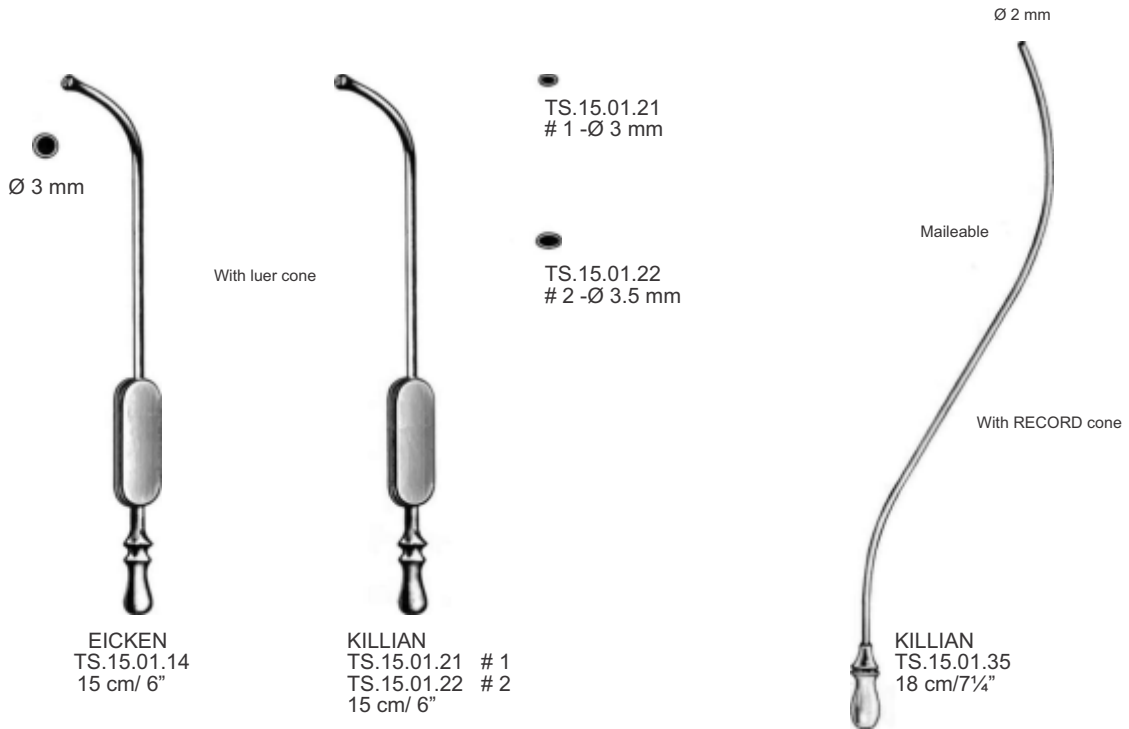

# 1 - Ø 1.5 mm

# 2 - Ø 1.5 mm



VAN ALYEA  
TS.15.02.45  
12 cm/ 4¾"

LUER-LOCK



VAN ALYEA  
TS.15.02.46  
12 cm/ 4¾"

# Nasal Instruments

# 1 - Ø 2 mm

# 2 - Ø 2 mm

Irrigating Tube for frontal sinus

Sterling Silver

With luer cone



VAN ALVEA  
 TS.15.02.51  
 15 cm / 6"

VAN ALVEA  
 TS.15.02.52  
 15 cm / 6"



Ø 2.5 mm



Ø 3.0 mm



SIEBENMANN  
 TS.15.02.25 Ø 2.5 mm  
 TS.15.02.30 Ø 3.0 mm  
 13cm / 5¼"

SIEBENMANN  
 TS.15.02.55 Ø 2.5 mm  
 TS.15.02.80 Ø 3.0 mm  
 13cm / 5¼"

# Nasal Instruments

## Irrigating Tubes

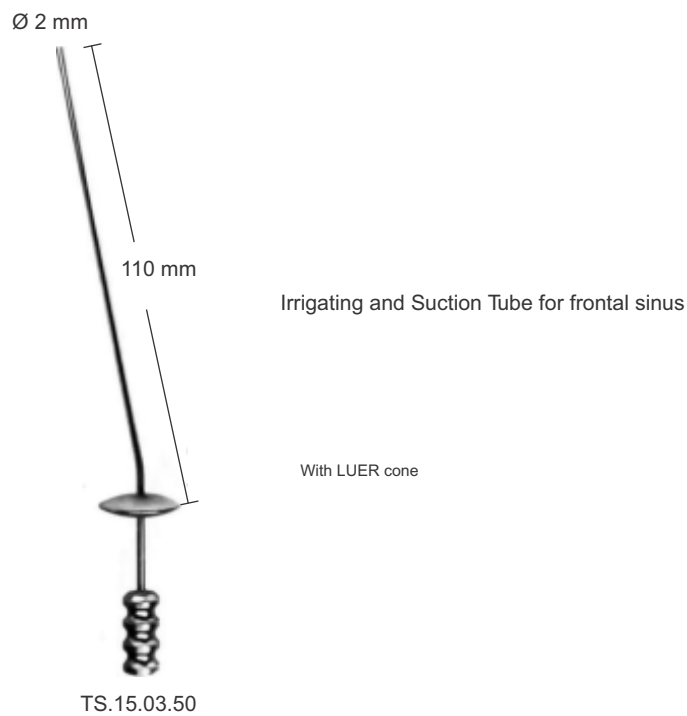
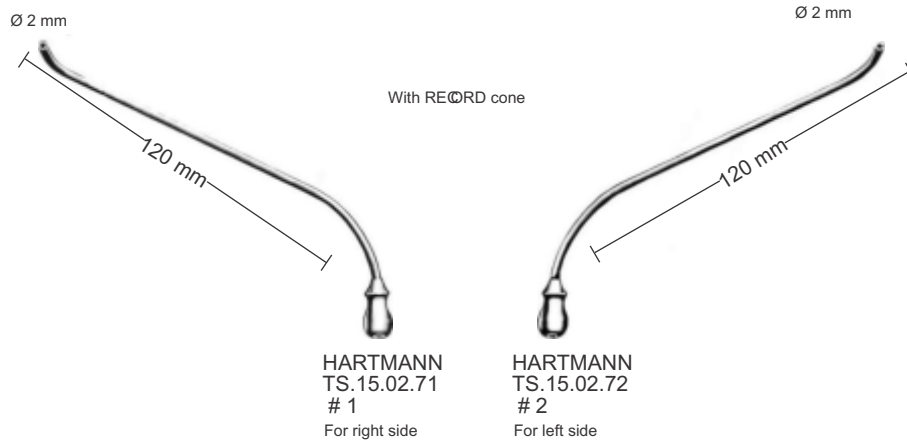



WIENER  
18 cm / 7¼"

Ø 3.5 mm



TS.15.04.33



TS.15.04.35

Antrum Rasps



Frontal Sinus Bougies

RITTER-HALLE  
TS.15.04.42 Ø 2.5 mm  
TS.15.04.43 Ø 3.0 mm  
TS.15.04.44 Ø 4.0 mm  
16 cm / 6¼"

30 X 10 mm



Serrated

Antrum Retractor

BRUENINGS-BRUNK  
TS.15.04.50  
19 cm / 7½"

# Nasal Instruments



KRAUSE  
TS.15.07.25  
25 cm/ 10"



KRAUSE/VOSS  
TS.15.07.30  
25 cm/ 10"



WILDE (BRUENINGS)  
TS.15.08.24  
25 cm/ 10"

Snare Wire



TS.15.07.40  
0.3 mm

Package / 100



TS.15.07.43 0.35 mm  
TS.15.07.44 0.40 mm  
TS.15.07.45 0.45 mm

Coil/10 meters

# Nasal Instruments



delicate pattern

HARTMANN  
 TS.15.04.16  
 16 cm/ 6¼"



standard pattern

HARTMANN  
 TS.15.05.18  
 20 cm/ 8"

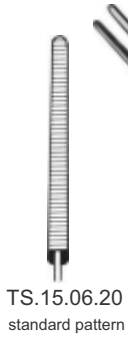

TS.15.06.20  
 standard pattern



TS.15.06.21  
 delicate pattern

WESTMACOTT  
 20 cm/ 8"



LUBET-BARBON  
 TS.15.06.30  
 20 cm/ 8"



# Nasal Instruments



NOYEN  
TS.15.07.30



NOYEN  
TS.15.07.31



TILLEY  
TS.15.07.35  
17 cm/ 6 3/4"

# Nasal Instruments



for infants

**BECKMANN**  
 TS.15.08.04  
 13 cm/ 5 1/8"



**HARTMANN**  
 15 cm/ 6"



TS.15.08.15  
 # 1



TS.15.08.16  
 # 2

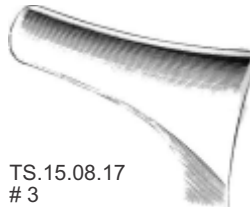

TS.15.08.17  
 # 3



TS.15.09.11  
 for infants

TS.15.09.10  
 for babies

**TIECK-HALLE**  
 13.5 cm/ 5 3/4"

For COTTLE Septum Specula  
 For Rhinoplasty

Pour COTTLE Speculums



**HARTMANN-HALLE**  
 TS.15.10.15 # 1  
 TS.15.10.16 # 2  
 TS.15.10.17 # 3  
 15 cm/ 6"



TS.15.10.15  
 TS.15.11.15  
 # 1



TS.15.10.16  
 TS.15.11.16  
 # 2

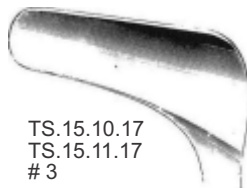

TS.15.10.17  
 TS.15.11.17  
 # 3



**HARTMANN-HALLE**  
 TS.15.11.15 # 1  
 TS.15.11.16 # 2  
 TS.15.11.17 # 3  
 15 cm/ 6"

aseptic joint  
 (dismantable)

# Nasal Instruments

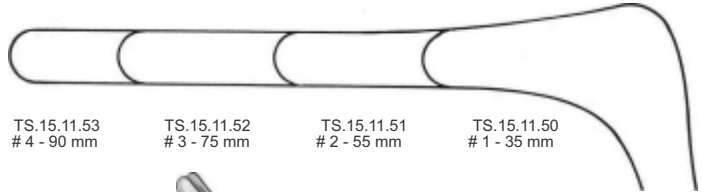

TS.15.11.53  
# 4 - 90 mm

TS.15.11.52  
# 3 - 75 mm

TS.15.11.51  
# 2 - 55 mm

TS.15.11.50  
# 1 - 35 mm

Nasal septum speculum



COTTLE  
TS.15.11.60  
14 cm/ 5½"



COTTLE  
TS.15.11.50 # 1  
TS.15.11.51 # 2  
TS.15.11.52 # 3  
TS.15.11.53 # 4  
14 cm/ 5½"

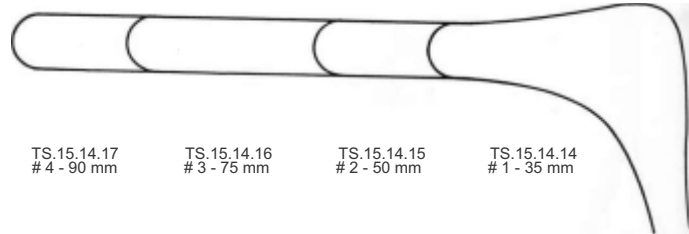

TS.15.14.17  
# 4 - 90 mm

TS.15.14.16  
# 3 - 75 mm

TS.15.14.15  
# 2 - 50 mm

TS.15.14.14  
# 1 - 35 mm



TS.15.13.15  
# 1



TS.15.13.16  
# 2



TS.15.13.17  
# 3



BECKMANN  
15 cm/ 6"



KILLIAN  
TS.15.14.14 # 1  
TS.15.14.15 # 2  
TS.15.14.16 # 3  
TS.15.14.17 # 4  
14 cm/ 5½"

# Nasal Instruments



"WIENER MODELL"  
15 cm / 6"



TS.15.15.14  
# 1



TS.15.15.15  
# 2

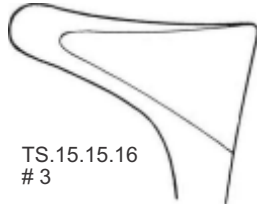

TS.15.15.16  
# 3

Economy Pattern



"WIENER MODELL  
STANDARD"  
15 cm / 6"

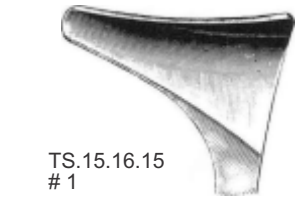

TS.15.16.15  
# 1



TS.15.16.16  
# 2



TS.15.16.17  
# 3



"WIENER MODELL"  
13 cm / 5 1/4"



TS.15.16.31  
# 1



TS.15.16.32  
# 2

Light pattern



TS.15.16.92  
14 cm / 5 1/2"



Economy, light-weight pattern

# Nasal Instruments



THUDILCHUM  
(GOLDSMITH)  
6.5 cm/ 2½"



TS.15.17.01  
# 1



TS.15.17.02  
# 2



TS.15.17.03  
# 3

Self-retaining



VOLTOLINI  
(DUPLAY)  
TS.15.17.11 #1  
TS.15.17.12 #2  
TS.15.17.13 #3

Self-retaining, spread adjustable by set screw

Serrated cutting blades

Angled to side



HEYMANN  
TS.15.17.18  
17 cm/ 6 $\frac{3}{4}$ "

HEYMANN  
TS.15.17.19  
17 cm/ 6 $\frac{3}{4}$ "

HEYMANN  
TS.15.17.20  
20 cm/ 8"

SEILER  
TS.15.17.46  
17 cm/ 6 $\frac{3}{4}$ "



TS.15.18.24



TS.15.18.25



TS.15.18.26

135 mm



Tubular shaft, lower cutting edge toothed

For sinuscopy

For rhinoplasty scissors

# Nasal Instruments

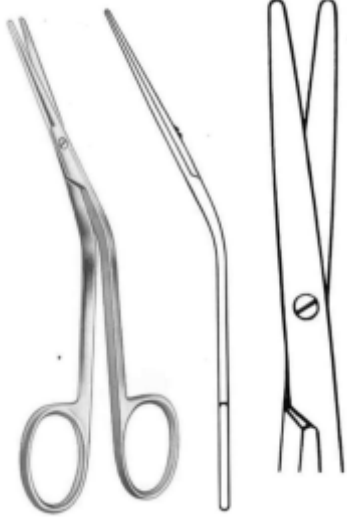

FOMON  
TS.15.50.13  
13 cm/ 5¼"



FOMON  
SUPERCUT  
TS.15.50.113  
13 cm/ 5¼"



FOMON  
SUPERCUT PLUS  
TS.15.50.163  
13 cm/ 5¼"



WALTER  
SUPERCUT  
TS.15.50.14  
14 cm/ 5½"

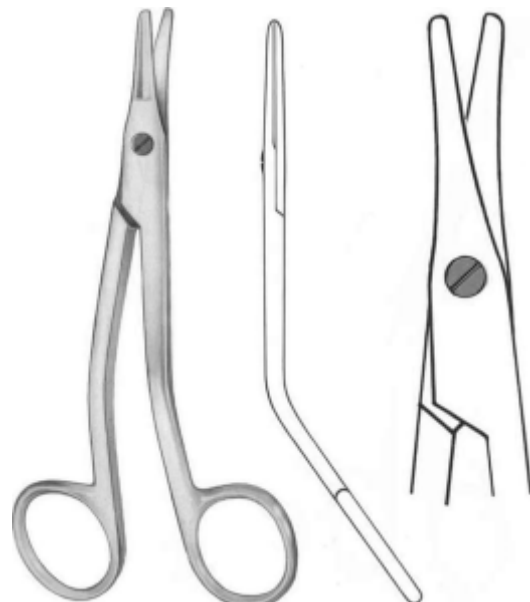

COTTLE-WALTER  
SUPERCUT  
TS.15.50.16  
16 cm/ 6¼"

# Nasal Instruments



COTTLE  
TS.15.51.16  
16 cm/ 6¼"

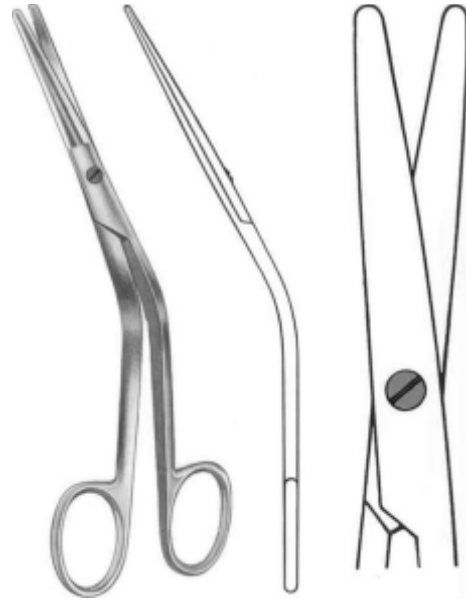

COTTLE  
SUPERCUT  
TS.15.51.116  
16 cm/ 6¼"



COTTLE  
"TC"  
TS.15.51.36  
16 cm/ 6¼"

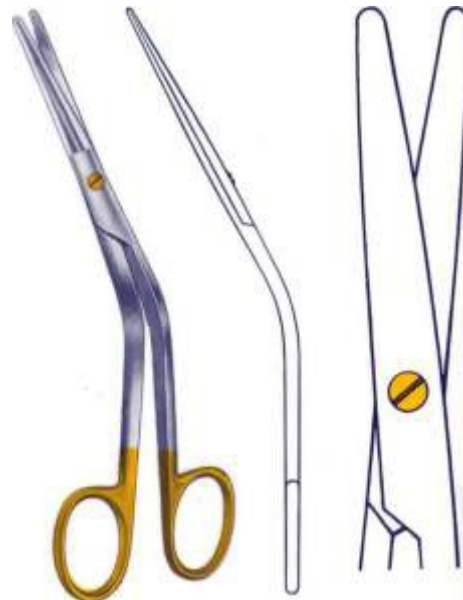

COTTLE  
SUPERCUT RIS  
TS.15.51.166  
16 cm/ 6¼"



# Nasal Instruments

Cartilage knife



MASING  
TS.15.19.13  
13 cm/ 5¼"

Septum knife, adjustable



spare blade

BRUENINGS  
TS.15.19.16  
16 cm/ 6¼"



FREER  
TS.15.20.15  
15 cm/ 6"



FREER  
TS.15.20.16  
16 cm/ 6¼"



FREER  
TS.15.20.17  
16 cm/ 6¼"

Mucosa knife

# Nasal Instruments

Swivel knife

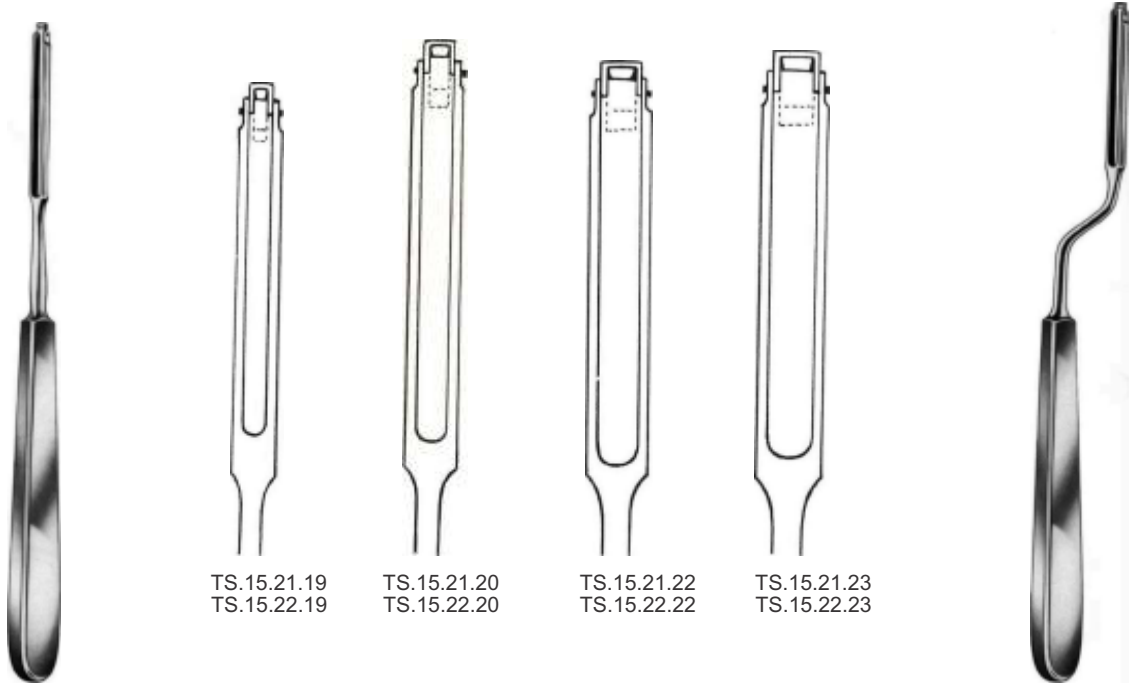

TS.15.21.19  
TS.15.22.19

TS.15.21.20  
TS.15.22.20

TS.15.21.22  
TS.15.22.22

TS.15.21.23  
TS.15.22.23

**BALLENGER**  
TS.15.21.19 3 mm  
TS.15.21.20 4 mm  
TS.15.21.22 5 mm  
TS.15.21.23 6 mm  
20 cm/ 8"

5 mm **BALLENGER**  
TS.15.22.19 3 mm  
TS.15.22.20 4 mm  
TS.15.22.22 5 mm  
TS.15.22.23 6 mm  
20 cm/ 8"

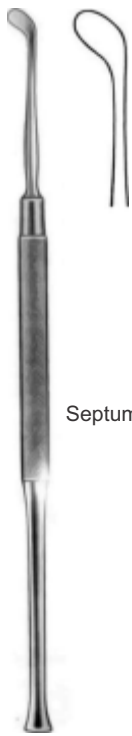

Septum knife

**FREER**  
TS.15.27.21  
19 cm/ 7½"



Submucosa knife

**FREER-INGALS**  
TS.15.27.17  
17 cm/ 6¾"

3.5 mm

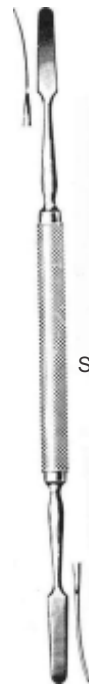

Sharp/blunt

**KILLAN**  
TS.15.34.18  
18 cm/ 7¼"



Sharp/blunt

**KILLIAN**  
TS.15.34.22  
23 cm/ 9"

# Nasal Instruments

## Septum gouges



**BALLENGER**  
TS.15.24.16 4 mm  
TS.15.24.17 6 mm  
16 cm/ 6¼"



**FREER**  
TS.15.25.16 4 mm  
TS.15.25.17 6 mm  
17 cm/ 6¾"



**KILLIAN**  
TS.15.25.46  
16 cm/ 6¼"



**KILLIAN-CLAUS**  
TS.15.25.47  
16 cm/ 6¼"

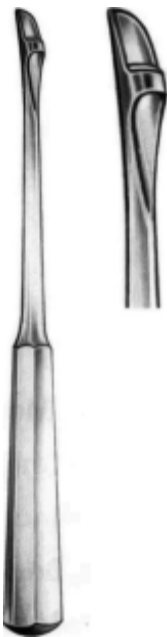

**FAULKNER**  
TS.15.25.57  
17 cm/ 6¾"

Cinzel para la apertura endonasal del seno maxilar

# Nasal Instruments



Sharp

Blunt

FREER  
 TS.15.27.22  
 19 cm / 7 1/2"

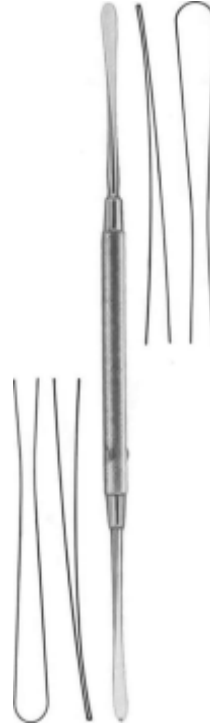

Sharp / Blunt

FREER  
 TS.15.28.21  
 21 cm / 8 1/4"

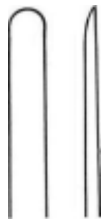

TS.15.29.11

Sharp



TS.15.29.12

Blunt



KILLIAN  
 17 cm / 6 3/4"



Blunt

HALLE  
 TS.15.30.32  
 17 cm / 6 3/4"

# Nasal Instruments



HOWARTH  
TS.15.30.40  
21.5 cm/ 8½"



PENNINGTON  
TS.15.30.50  
20 cm/ 8"



PIERCE  
TS.15.30.55  
20 cm/ 8"



Antrum elevator

SEWALL  
TS.15.30.70  
20 cm/ 8"

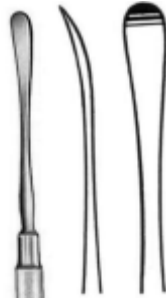

Sharp



FREER-JOSEPH  
TS.15.30.79  
19.5 cm/ 7¾"



Sharp/Blunt

HAJEK-BALLENGER  
TS.15.30.80  
20 cm/ 8"

# Nasal Instruments



KISTNER  
17 cm/ 6¾"



TS.15.31.60



TS.15.31.61



Obturator

CHONA HOOK



TS.15.31.62  
14.5 cm/ 5¾"



KILLIAN  
TS.15.31.63  
15 cm/ 6"

LANGE  
TS.15.31.65  
23 cm/ 9"

# Nasal Instruments

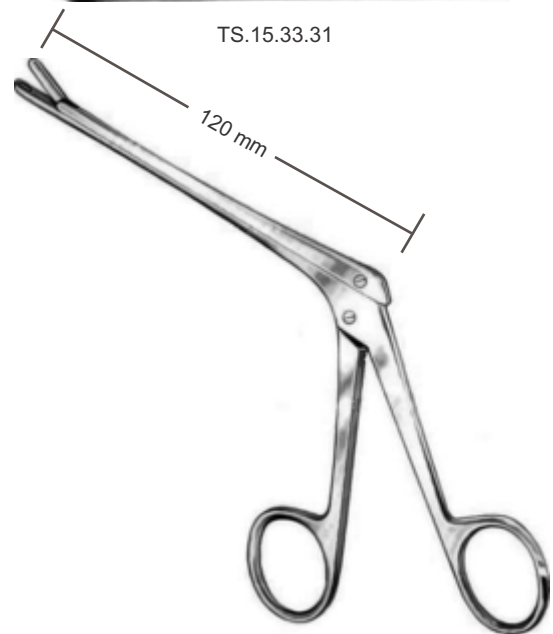
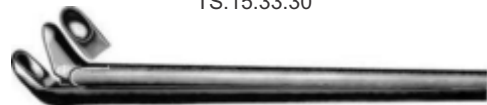
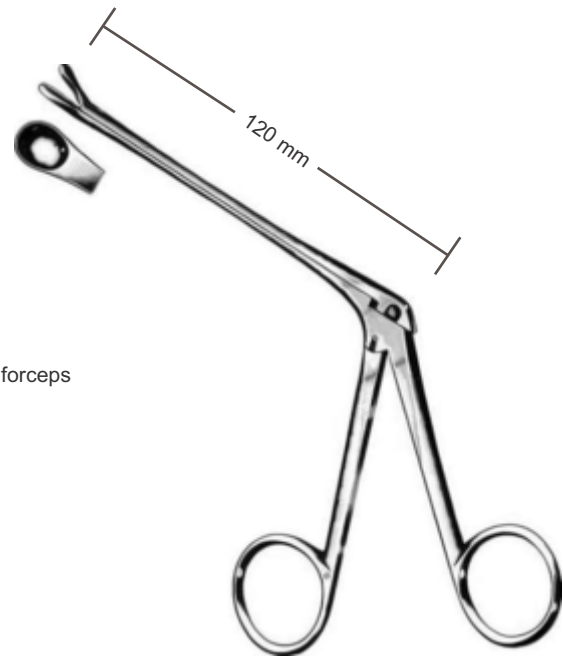
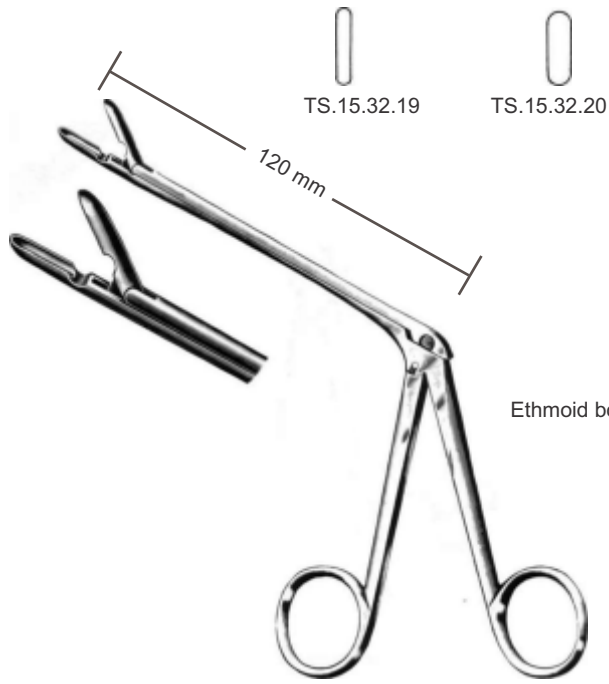

# Nasal Instruments



LUC-BRUENINGS  
 (HEYMANN)  
 18 cm / 7¼"



TS.15.34.11  
 # 1



TS.15.34.12  
 # 2

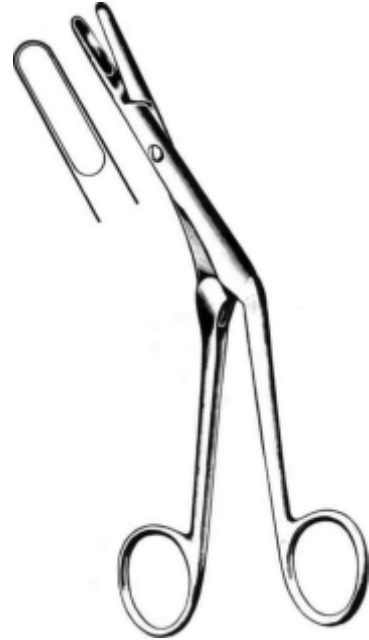

CRAIG  
 TS.15.34.15  
 17 cm / 6¾"



CRAIG-DOMNICK  
 17 cm / 6¾"



TS.15.34.16



TS.15.34.17



LUC  
 19 cm / 7½"



TS.15.34.21  
 # 1



TS.15.34.22  
 # 2

Ethmoid bone forceps



TS.15.34.23  
 # 3



# Nasal Instruments

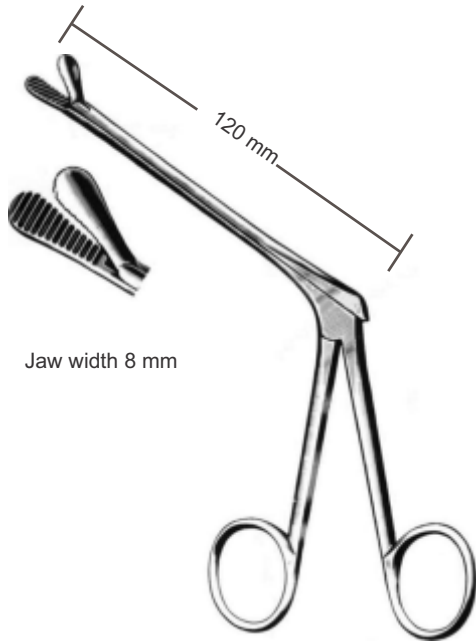

Jaw width 8 mm

BLAKESLEY  
TS.15.34.51

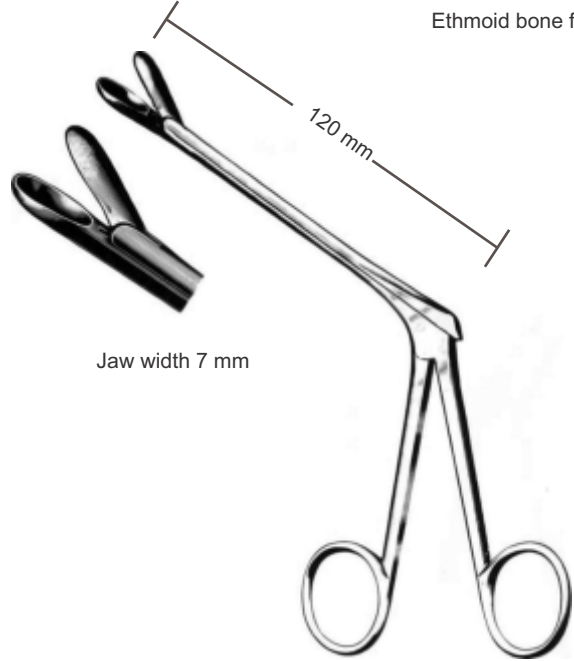

Ethmoid bone forceps

Jaw width 7 mm

WATSON-WILLIAMS  
TS.15.34.55

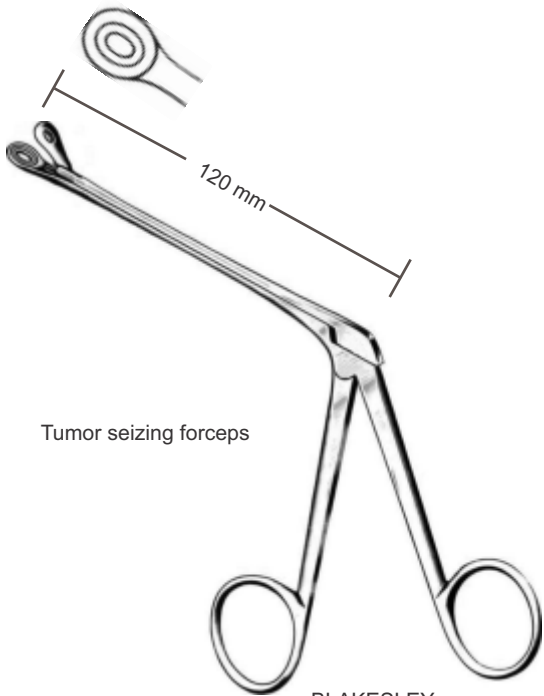

Tumor seizing forceps

BLAKESLEY  
(LEWIS)



TS.15.34.61



TS.15.34.62



TS.15.34.63

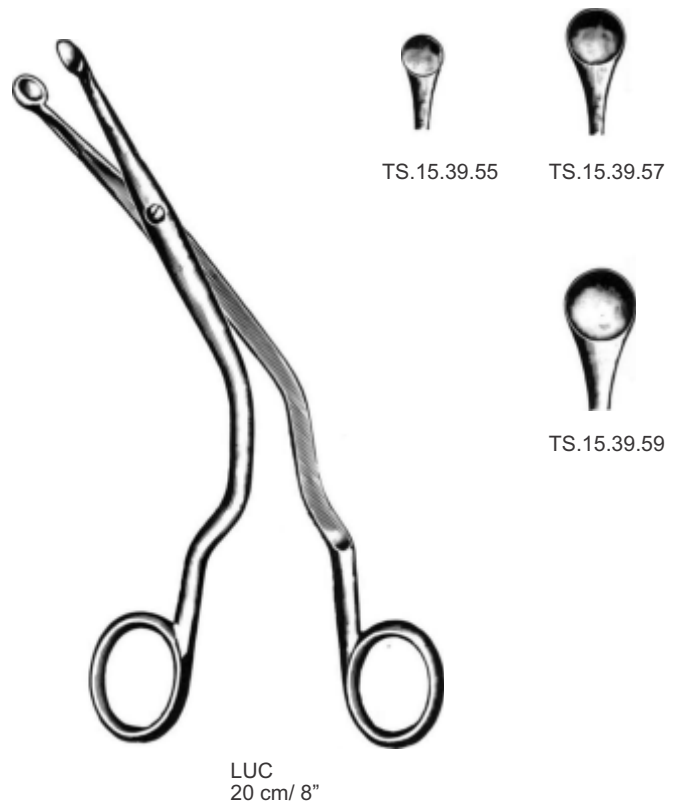
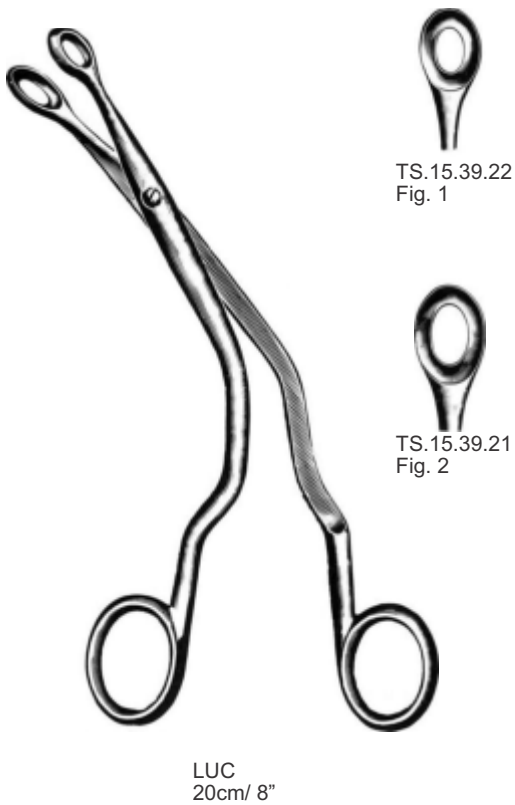
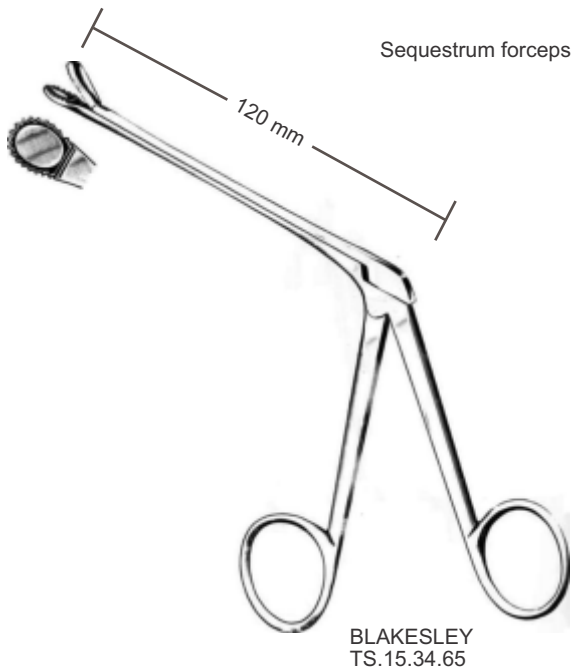

# Nasal Instruments



**BRUENINGS**  
19 cm / 7½"

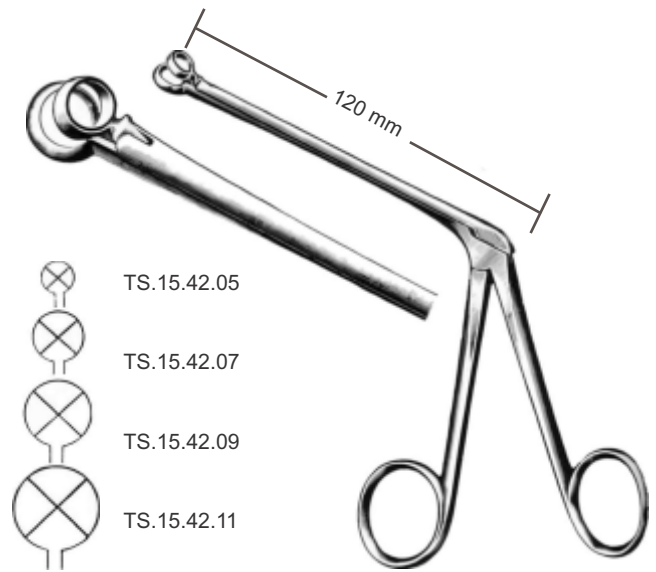
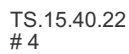

**HARTMANN**  
TS.15.42.05 # 1  
TS.15.42.07 # 2  
TS.15.42.09 # 3  
TS.15.42.11 # 4

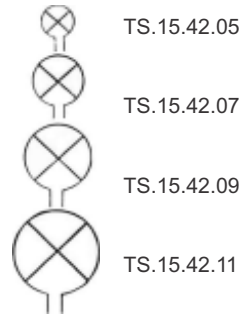

**WATSON-WILLIAMS**  
TS.15.43.01 # 1  
TS.15.43.02 # 2  
TS.15.43.03 # 3

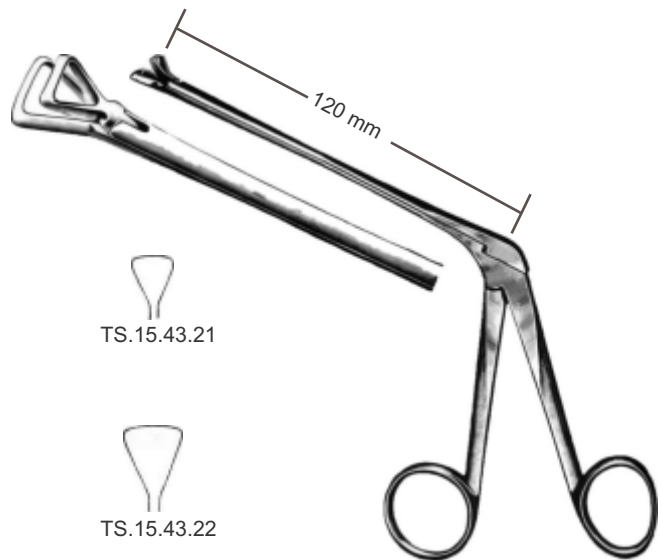

**SCHMEDEN**  
TS.15.43.21 # 1  
TS.15.43.22 # 2  
TS.15.43.23 # 3



# Nasal Instruments



WEIL-BLAKESLEY  
19 cm / 7½"



TS.15.44.01  
# 1



TS.15.44.02  
# 2



TS.15.44.03  
# 3



TS.15.44.04  
# 4



TS.15.44.05  
# 5

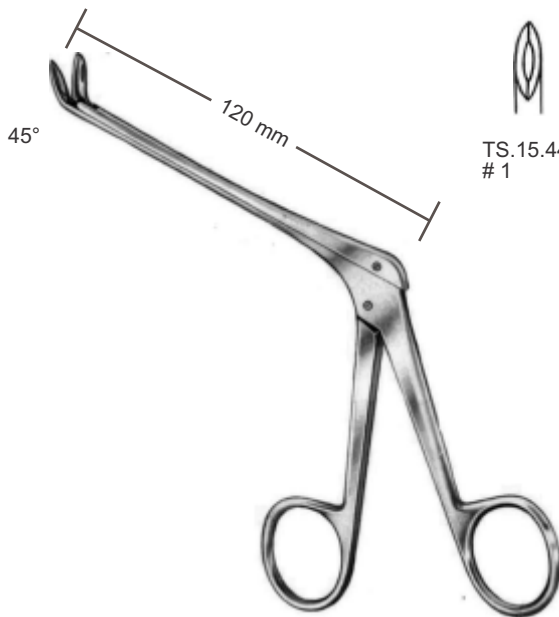

WEIL-BLAKESLEY



TS.15.44.10  
# 1



TS.15.44.11  
# 2



TS.15.44.12  
# 3



TS.15.44.13  
# 4



TS.15.44.14  
# 5

Ethmoid bone forceps

# Nasal Instruments



WELLBLAKESLEY



TS.15.45.11  
# 1



TS.15.45.12  
# 2



TS.15.45.13  
# 3



TS.15.45.14  
# 4

# Nasal Instruments



STRUCKEN  
 TS.15.46.21



HENKE  
 TS.15.45.15



TS.15.45.21    TS.15.45.22    TS.15.45.23

HAJEK-GRUENWALD  
 TS.15.45.21 #1  
 TS.15.45.22 #2  
 TS.15.45.23 #3



TS.15.45.31    TS.15.45.32    TS.15.45.33    TS.15.45.34

MYLES  
 TS.15.45.31 #1  
 TS.15.45.32 #2  
 TS.15.45.33 #3  
 TS.15.45.34 #4

# Nasal Instruments

Antrum punch, retrograde cutting



TS.15.47.51

Up cutting



STAMMBERGER



TS.15.47.52

Cutting right



TS.15.47.53

Cutting left



JANSEN-MIDDLETON  
TS.15.48.19  
19 cm/ 7½"

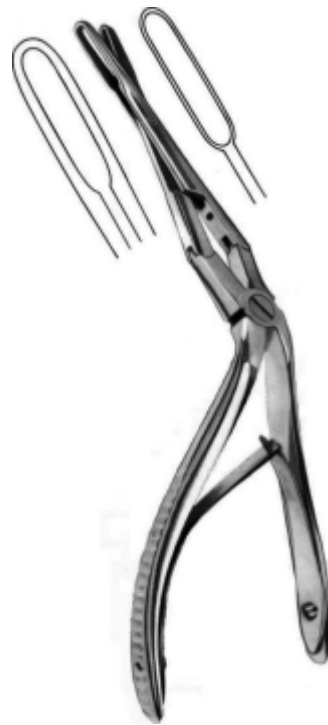

JANSEN-MIDDLETON  
TS.15.49.19  
19 cm/ 7½"



# Nasal Instruments

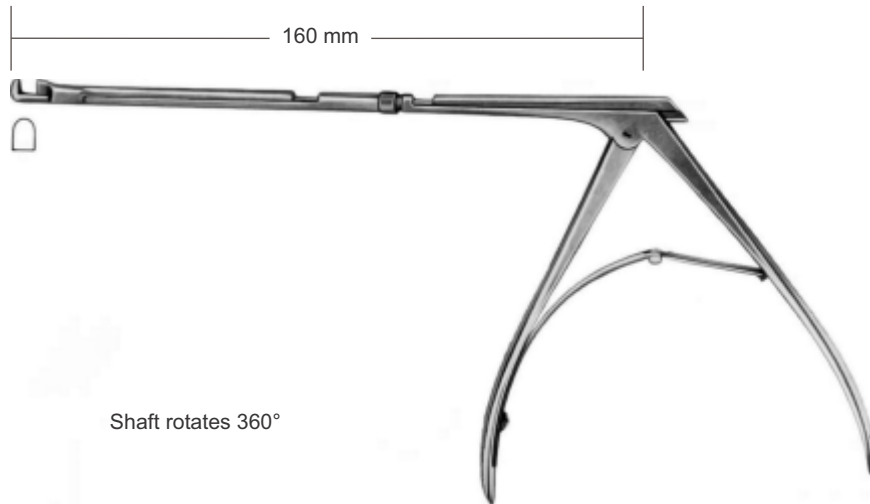

HAJEK-KOFLER  
TS.15.66.10

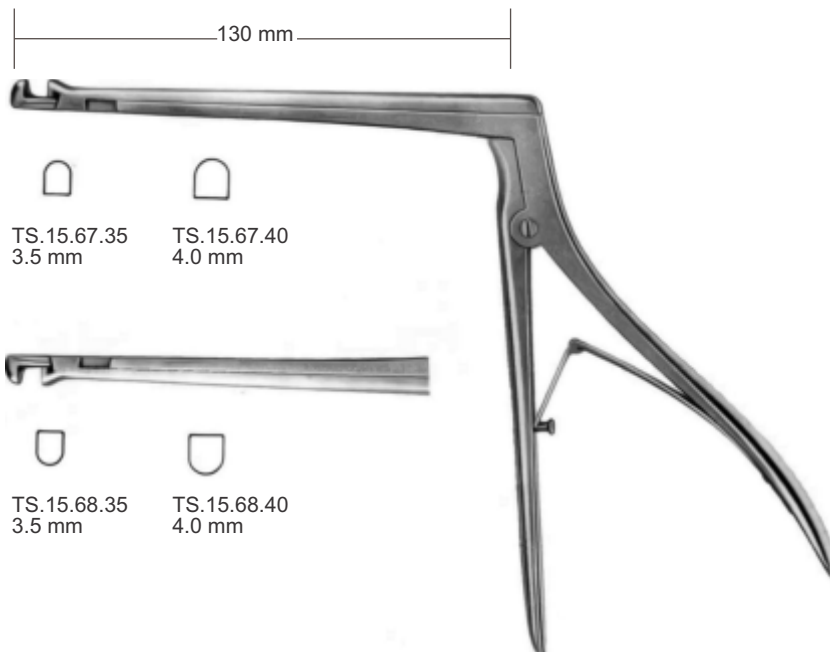

HAJEK



HAJEK-CLAUS  
TS.15.70.20  
20 cm / 8"

# Nasal Instruments

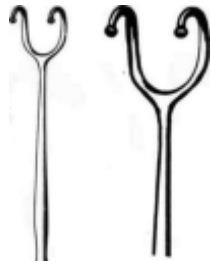

10 mm

Alar retractor

FOMON  
 TS.15.01.17  
 17 cm/ 6¾"



10 mm

With guide

NEIVERT  
 TS.15.01.19  
 19.5 cm/ 7¾"



18 mm

With guide

MASING  
 TS.15.01.20  
 20 cm/ 8"



10 mm

COTTLE-NEIVERT  
 TS.15.01.21  
 21 cm/ 8¼"

"Finger-ring" retractor



10 mm

Sharp



MILLARD (COTTLE)  
 TS.15.01.23  
 5.5 cm/ 2¼"



10 mm

COTTLE  
 TS.15.01.44  
 15 cm/ 6"

# Nasal Instruments



COTTLE  
TS.15.02.14  
14 cm / 5½"



COTTLE  
TS.15.03.14  
14 cm / 5½"



COTTLE  
TS.15.04.14  
14 cm / 5½"

## Alar retractor



KILNER  
TS.15.04.10  
10 cm / 4"



CONVERSE  
TS.15.09.12  
12 cm / 4¾"

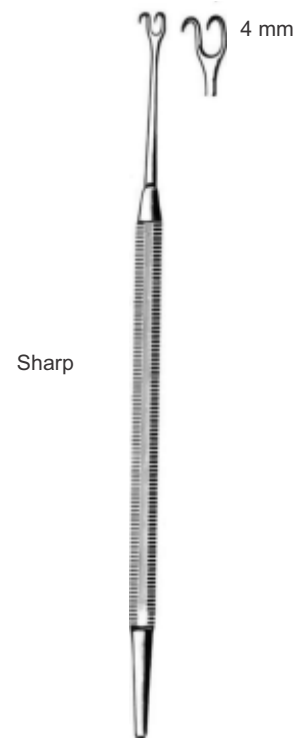

COTTLE  
TS.15.04.15  
15 cm / 6"

# Nasal Instruments

14 cm



Wide

COTTLE  
 TS.15.05.14  
 14 cm / 5½"

22 x 13 mm



Alar retractor

COTTLE  
 TS.15.05.16  
 15 cm / 6"



AUFRICHT-WALTER  
 TS.15.06.14  
 13.5 cm / 5¾"

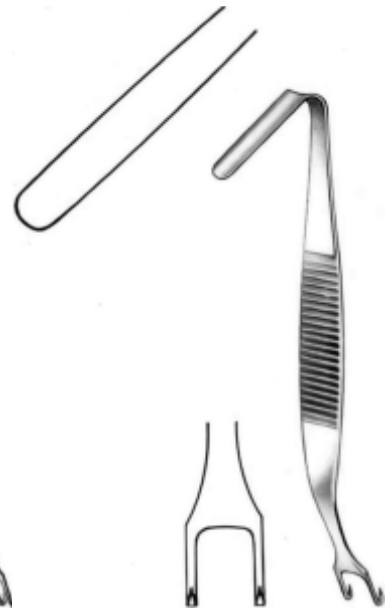

AUFRICHT-WALTER  
 TS.15.06.15  
 13.5 cm / 5¾"

40 x 13 mm



blunt

AUFRICHT  
 TS.15.06.17  
 13.5 cm / 5¾"

45 x 9/7 mm



AUFRICHT  
 TS.15.10.19  
 18 cm / 7¼"

# Nasal Instruments



TS.16.07.01  
No. 1 - 40 mm



TS.16.07.02  
No. 2 - 50 mm



TS.16.07.03  
No. 3 - 55 mm

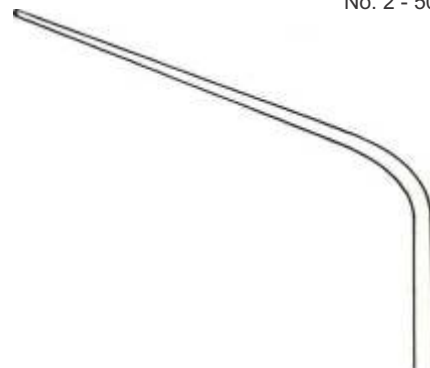

TS.16.07.04  
No. 4 - 70 mm



COTTLE

TS.16.07.00  
Set/4 sizes (No, 1-4)

# Nasal Instruments



JOSEPH  
TS.16.11.06  
15 cm/ 6"

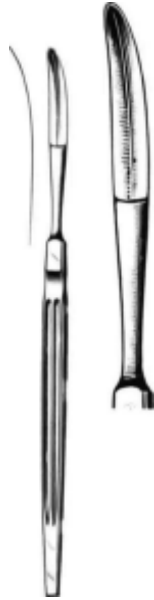

JOSEPH  
TS.16.11.08  
15 cm/ 6"

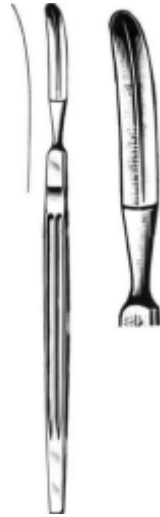

FOMON  
TS.16.11.15  
15 cm/ 6"



JOSEPH  
TS.16.12.15  
15 cm/ 6"



Nasal knife

COTTLE  
TS.16.13.14  
14 cm/ 5½"

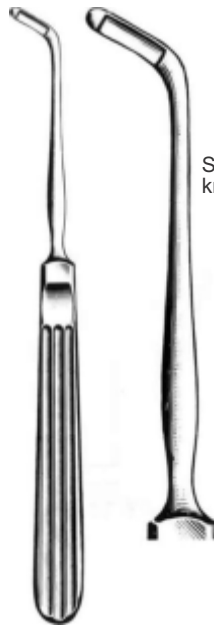

Septum cartilage  
knife

JOSEPH  
TS.16.13.16  
16 cm/ 6¼"

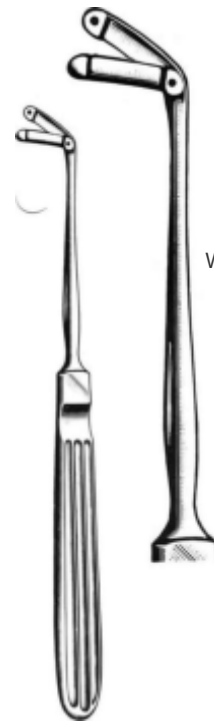

With blade guard

MALTZ  
TS.16.13.26  
16 cm/ 6¼"

# Nasal Instruments



CONVERSE  
TS.16.14.15  
15 cm/ 6"



Nasal knife

COTTLE  
TS.16.14.16  
15 cm/ 6"

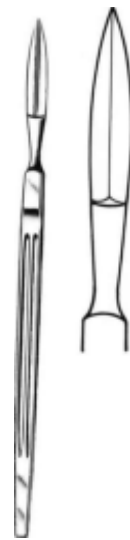

COTTLE  
TS.16.15.15  
15 cm/ 6"

# Nasal Instruments



Guide and guard for nasal saw

JOSEPH  
 TS.16.20.15  
 15 cm/ 6"

JOSEPH  
 TS.16.17.26  
 L

JOSEPH  
 TS.16.17.27  
 R



JOSEPH  
 TS.16.18.23  
 17 cm/ 6 3/4"



JOSEPH  
 TS.16.19.24  
 R.17 cm/ 6 3/4"



JOSEPH  
 TS.16.20.24  
 L.17 cm/ 6 3/4"



# Nasal Instruments



**COTTLE**  
TS.16.21.24  
21 cm/ 8¼"

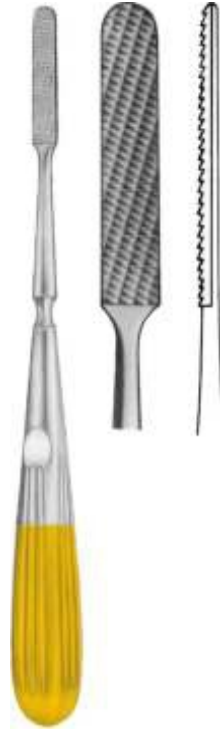

**COTTLE "TC"**  
TS.16.21.25  
20.5 cm/ 8"

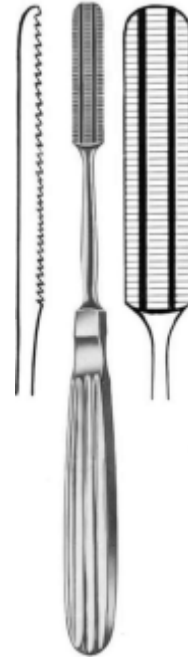

**MALTZ**  
TS.16.22.25  
18 cm/ 7¼"

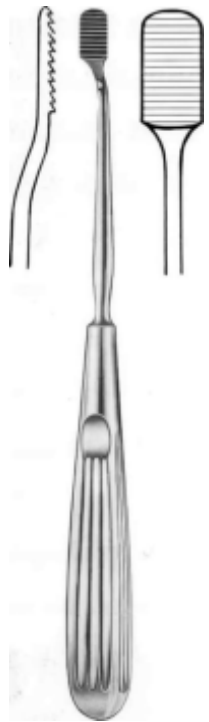

**LEWIS**  
TS.16.24.26  
20 cm/ 8"

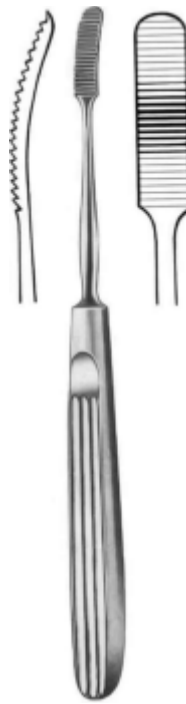

**TS.16.23.47**  
19.5 cm/ 7¾"



**LEWIS "TC"**  
TS.16.23.50  
19.5 cm/ 7¾"

# Nasal Instruments



DINGMAN  
 TS.16.24.35  
 15 cm/ 6"  
 # 1 - L

Cartilage Abraders

DINGMAN  
 TS.16.24.10  
 Set of 2 (# 1 and 2)



DINGMAN  
 TS.16.24.36  
 15 cm/ 6"  
 # 2 - R



AUFRICHT  
 TS.16.25.26  
 21 cm/ 8¼"



AUFRICHT  
 TS.16.25.27  
 21 cm/ 8¼"



AUFRICHT  
 TS.16.25.28  
 21 cm / 8¼"



FOMON  
 TS.16.25.32  
 22 cm/ 8¾"

# Nasal Instruments

Bone splinters are pushed through the perforated working ends. This avoids plugging of the rasps and they can be cleaned easily

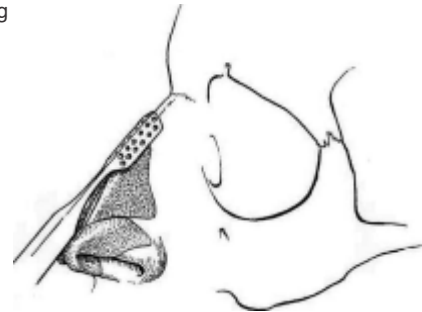

OBWEGESER  
TS.16.25.41 Delicate pattern    TS.16.25.42 Medium fine



OBWEGESER  
TS.16.25.43 Delicate pattern    TS.16.25.44 Medium fine



OBWEGESER  
TS.16.25.45 Delicate pattern    TS.16.25.56 Medium fine

One working end of the instruments operates by pushing, the other by pulling.

Nasal files



CONVERSE  
TS.16.25.65  
18.5 cm / 7¼"

Nasal rasp



MASING  
TS.16.25.70  
21 cm / 8¼"



MASING  
TS.16.25.71  
21 cm / 8¼"

# Nasal Instruments



20 cm / 8"  
"TC"



1



3



5



7



9



2

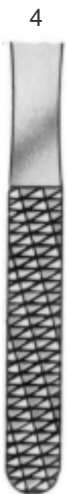

4

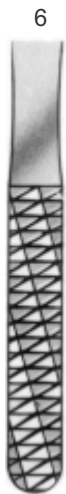

6



8

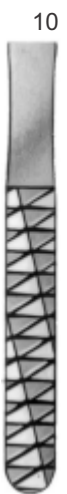

10

TS.16.25.80

TS.16.25.81

TS.16.25.82

TS.16.25.83

TS.16.25.84

Septum straightening forceps



ASCH  
TS.16.29.21  
22 cm / 8 $\frac{3}{4}$ "

Septum Cutter

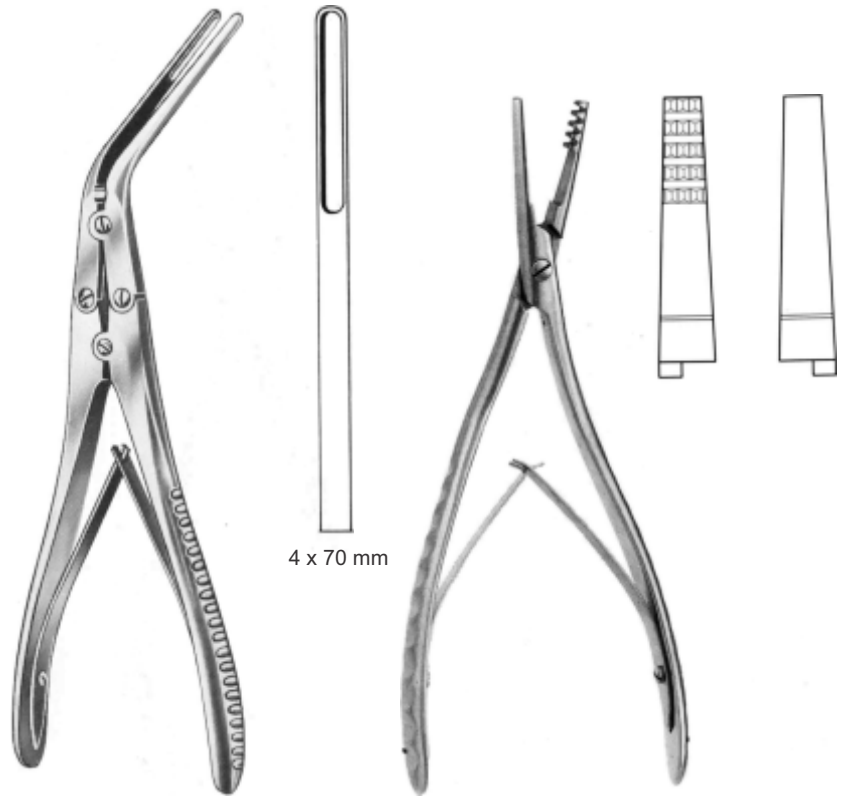

KRESSNER  
TS.16.29.22  
21 cm / 8 $\frac{1}{4}$ "

OBWEGESER  
TS.16.29.23  
18.5 cm / 7 $\frac{1}{4}$ "

# Nasal Instruments

## Septum Straightening Forceps



WALSHAM  
"UNIVERSAL"  
TS.16.30.21  
23 cm/ 9"



R  
TS.16.30.22



L  
TS.16.30.23

Dismantleable



COTTLE-FOMON  
TS.16.30.24  
21 cm/ 8¼"

Septum Morselizer

With protective guard



RUBIN  
TS.16.30.31  
21 cm / 8¼"

Cartilage morselizer

25 x 20 mm

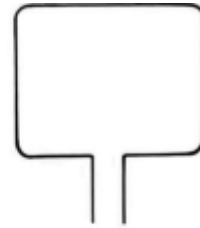

TSCHOEPE  
TS.16.30.32  
19 cm / 7½"



Protective guard only

According to the operating needs, the cap may be placed either on the right or the left jaw



# Nasal Instruments

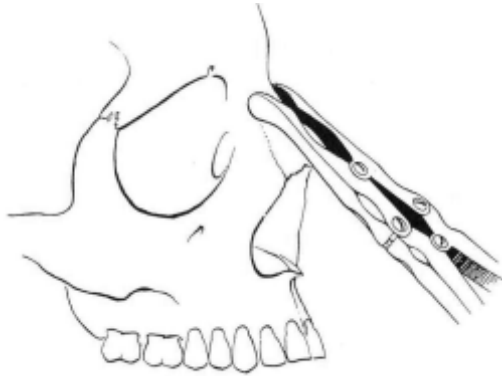

Used to reduce the angle between nose and forehead by delicate biting of the bone.



OBWEGESER  
18.5 cm / 7 1/4"



TS.16.30.34  
4 mm



TS.16.30.36  
6 mm



TS.16.30.38  
8 mm

Measuring instrument



JOSEPH  
TS.16.30.47  
17 cm/ 6¾"

Graduated in centimeters

Mucosa needle holder

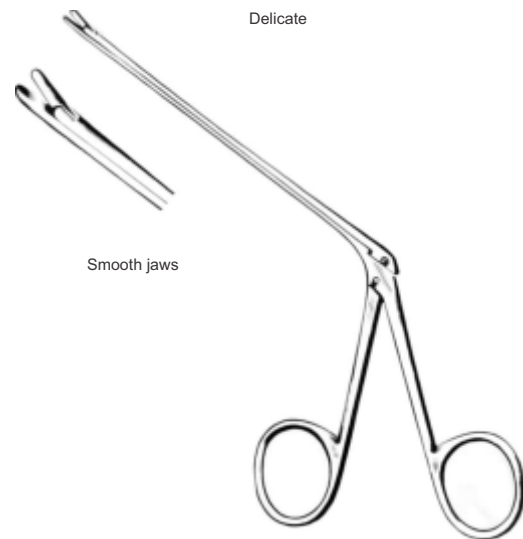

Delicate

Smooth jaws

COTTLE-MASING  
TS.16.30.56  
60 mm

Length of shaft

COTTLE-MASING  
TS.16.30.59  
90 mm

Length of shaft

# Nasal Instruments

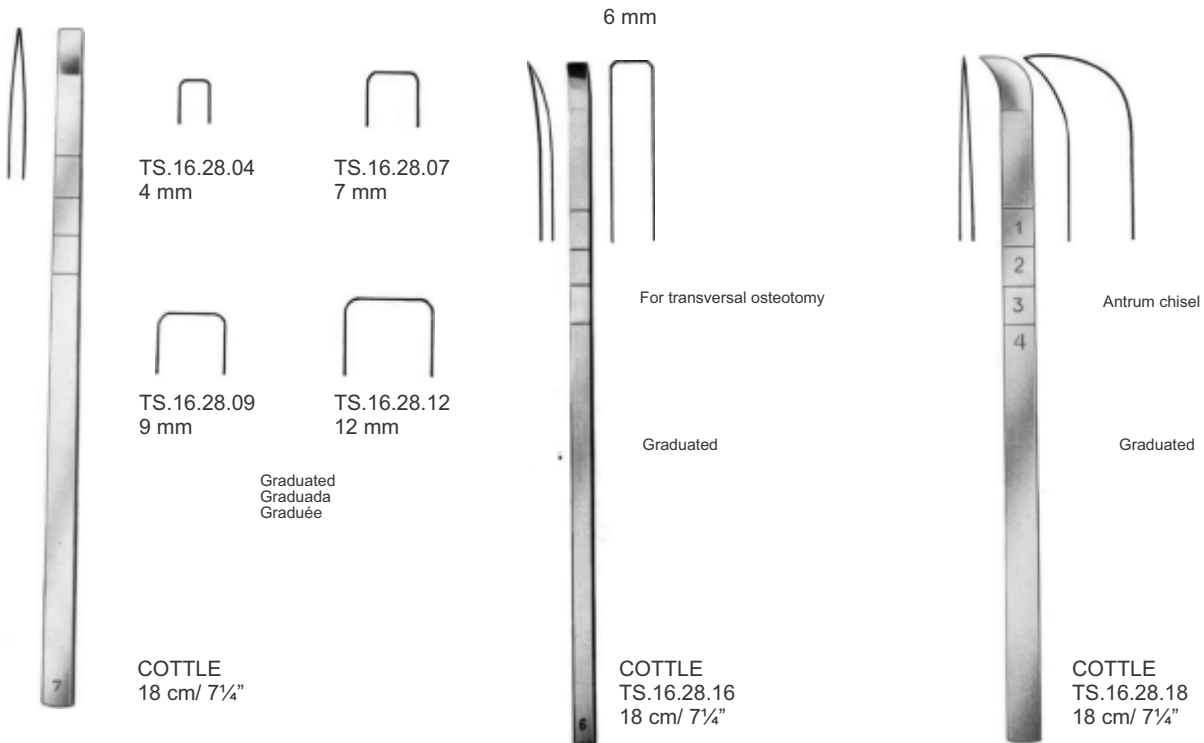

"Fishtail"

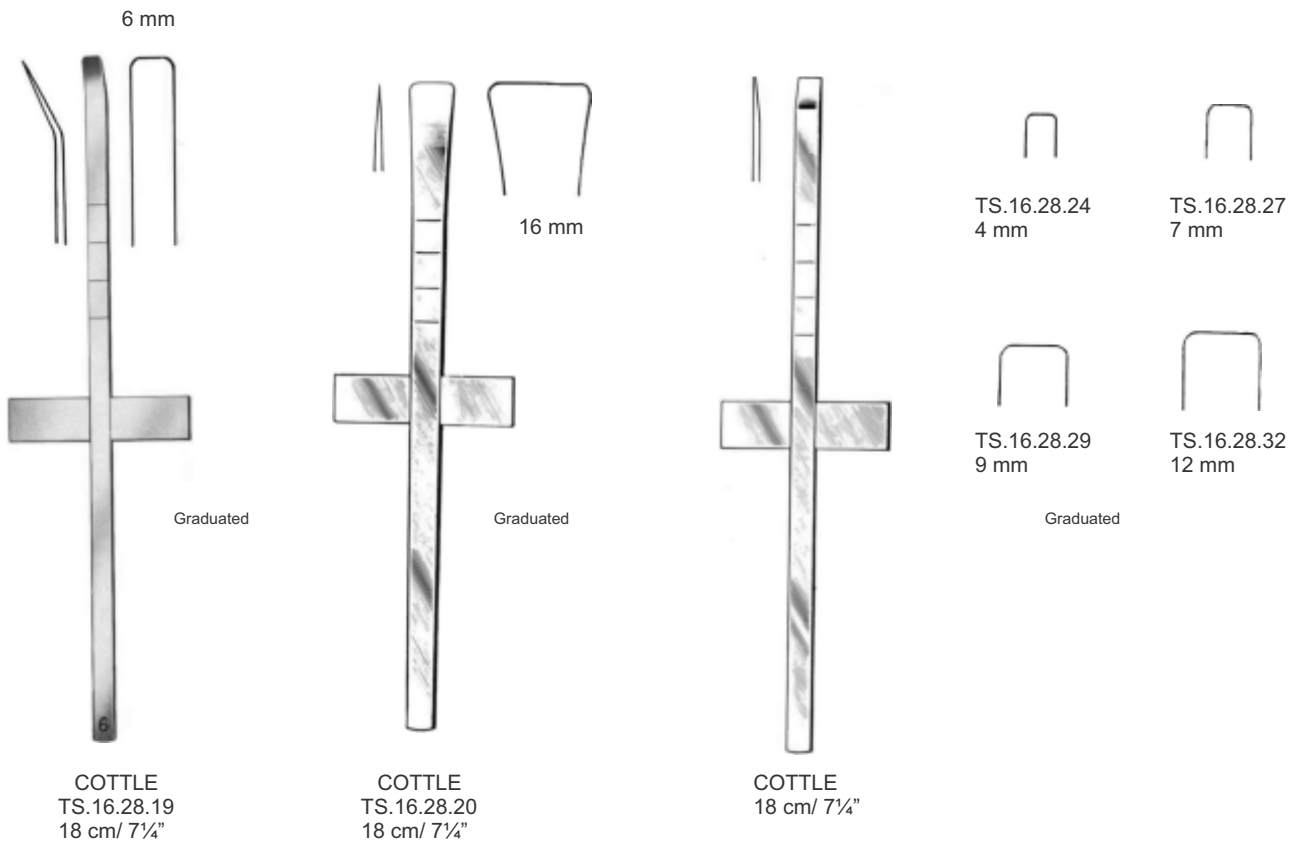

# Nasal Instruments

"Fishtail"



16 mm

Graduated  
 Graduado  
 Graduée

**COTTLE**  
 TS.16.28.38  
 18 cm / 7¼"



TS.16.28.40  
 10 mm



TS.16.28.44  
 14 mm

**RUBIN**  
 18 cm / 7¼"



10 mm

Bone lever and splitting osteotome

**COTTLE**  
 TS.16.28.50  
 20 cm / 8"



**FANOUS**  
 19.5 cm - 7¾"

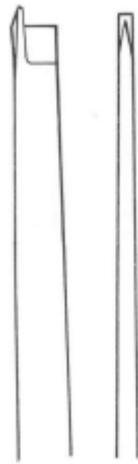

TS.16.28.54



TS.16.28.55

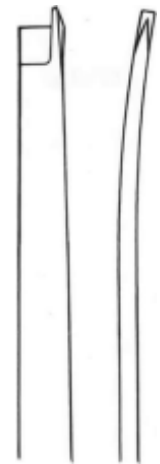

TS.16.28.56

# Nasal Instruments

3 mm



TS.16.28.63

5 mm



TS.16.28.65

2 mm



TS.16.28.72

3 mm

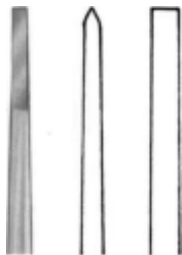

TS.16.28.73

4 mm



TS.16.28.74

7 mm

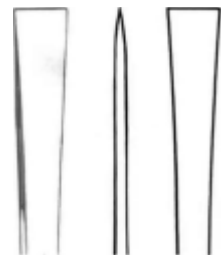

TS.16.28.77



WALTER  
19 cm - 7½"

9 mm

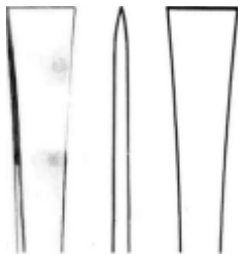

TS.16.28.79

12 mm

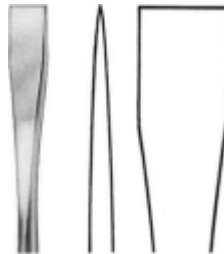

TS.16.28.82

6 mm



TS.16.28.86

# Nasal Instruments

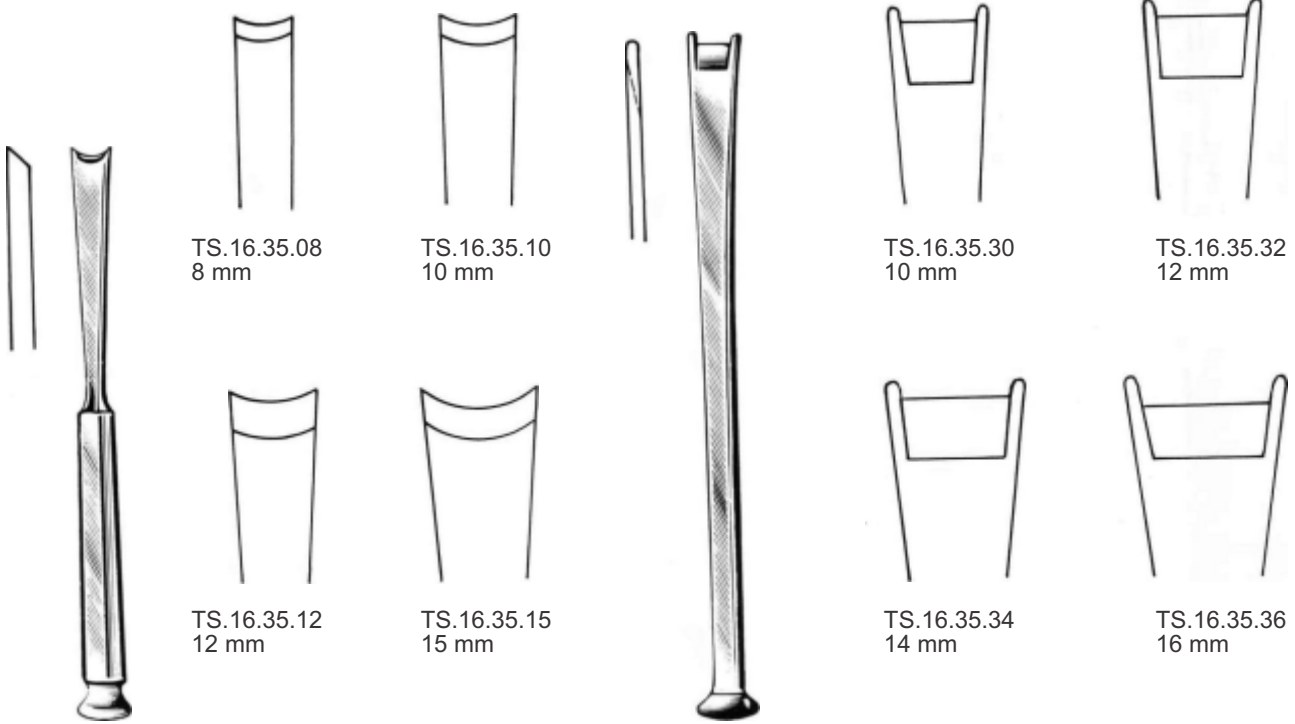

**MCINDOE**  
16 cm - 6¼"

**MOBERG**  
18 cm - 7¼"

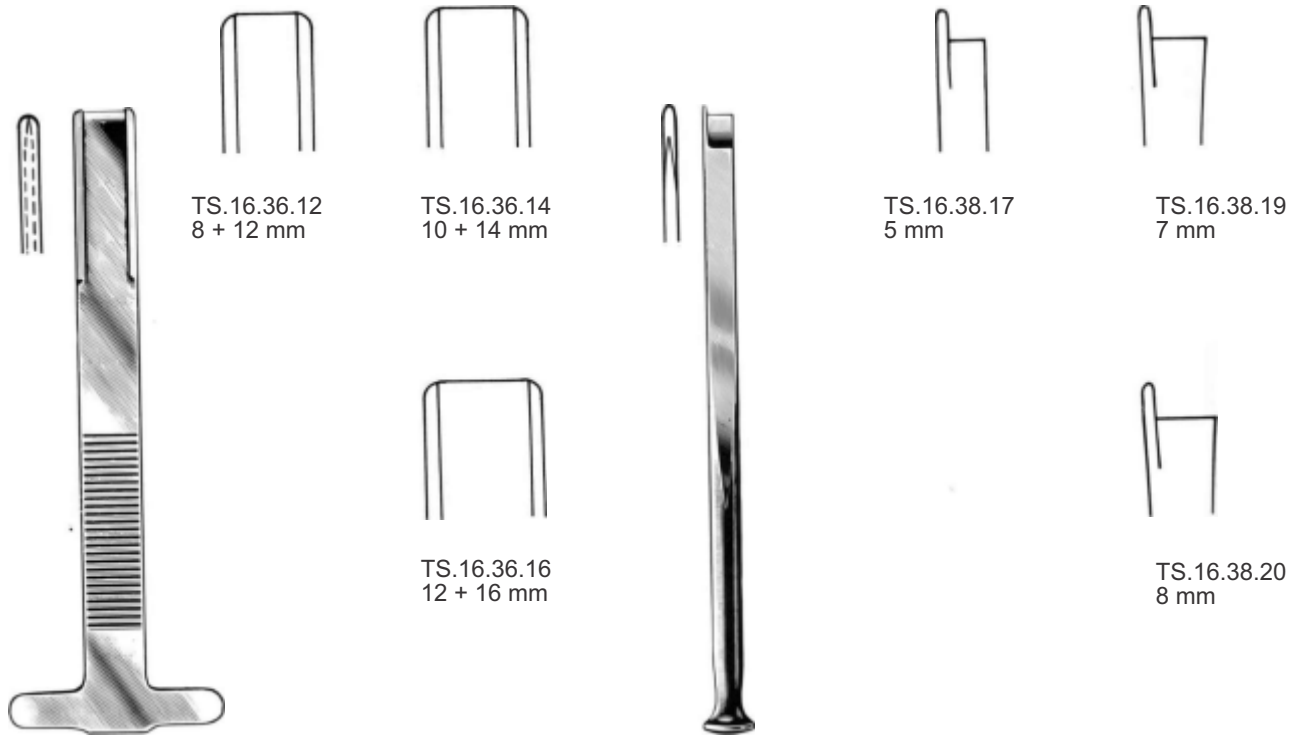

**RUBIN**  
18 cm - 7¼"

**FOMON**  
17 cm - 6¾"

# Nasal Instruments



CINELLI  
16 cm - 6 1/4"

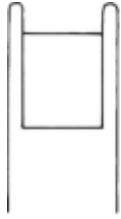

TS.16.39.10  
10 mm

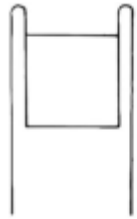

TS.16.39.12  
12 mm

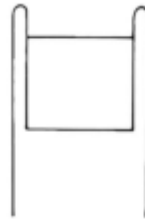

TS.16.39.14  
14 mm

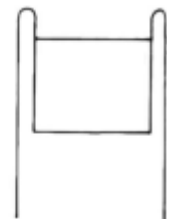

TS.16.39.16  
16 mm

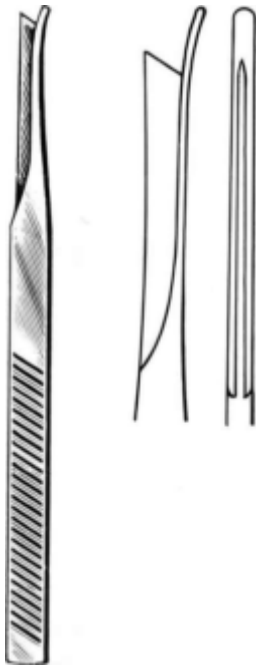

SILVER  
TS.16.40.01  
18 cm - 7 1/4"

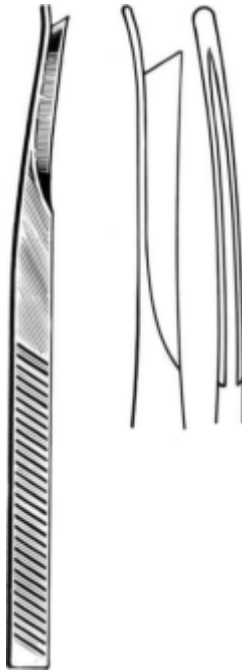

SILVER  
TS.16.40.02  
18 cm - 7 1/4"

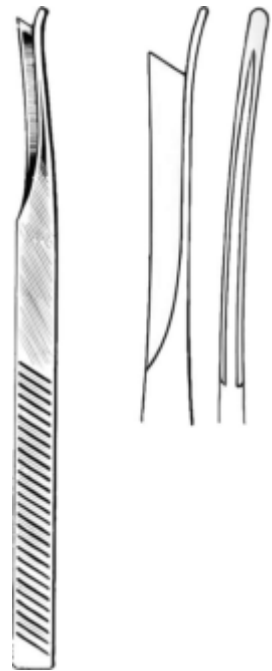

SILVER  
TS.16.40.03  
18 cm - 7 1/4"

# Nasal Instruments



**COTTLE**  
 18 cm - 7¼"

8 mm



Raspatory

TS.16.31.19

Sharp  
 Agudo  
 Tranchant

8 mm



Elevator

TS.16.31.20

Blunt  
 Rombo  
 Mousse

Sharp

8 mm



Septum raspatory

**JOSEPH-MASING**  
 TS.16.31.48  
 22 cm - 8¾"

Blunt

6 mm



Septum elevator

**YANKAUER**  
 TS.16.31.55  
 18 cm - 7¼"



# Nasal Instruments

Blunt



Elevator for fracture repositioning  
of the nasal bone

TS.16.31.60  
17 cm/ 6¾"

Sharp



Raspatory

CONVERSE  
TS.16.31.65  
18 cm/ 7¼"

Blunt



Nasal fracture elevator

BOLES  
TS.16.31.69  
19 cm/ 7½"

Blunt



Septum displacer

GOLDMANN  
TS.16.31.75  
17 cm/ 6¾"

## Periosteal Elevators



COTTLE  
TS.16.32.21  
21 cm/ 8¼"



MASING  
TS.16.32.52  
22 cm/ 8¾"

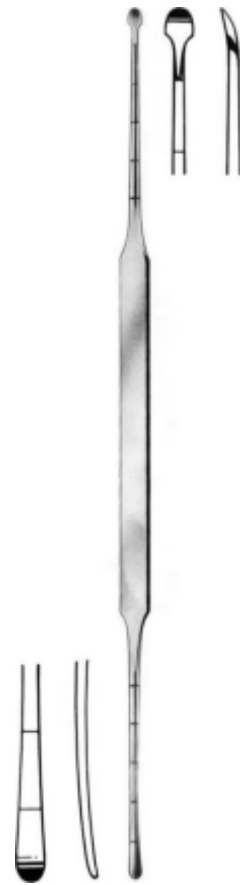

COTTLE  
TS.16.32.23  
23 cm/ 9"

# Nasal Instruments

Suction elevator



TS.16.33.21  
21 cm / 8¼"

Suction raspatory



With guide

TS.16.33.20  
20 cm / 8"

Septum elevator



COTTLE  
16 cm / 6¼"

# Nasal Instruments

Periosteum comb and file



COTTLE  
 TS.16.34.24  
 23 cm/ 9"

Raspatory



COTTLE-MCKENTY  
 TS.16.34.22  
 22 cm/ 8¾"

Tunnelling elevator



COTTLE  
 TS.16.34.23  
 22 cm/ 8¾"

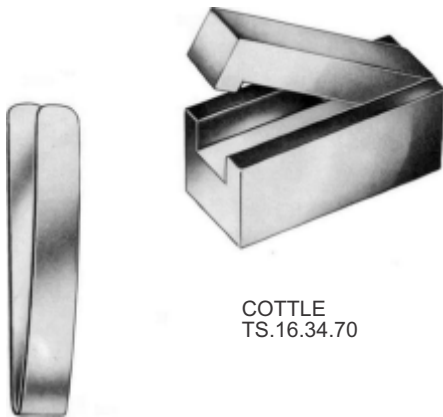

COTTLE  
 TS.16.34.70

Cartilage crusher with Clamp for taking out the prepared material

# Nasal Instruments

Ø 30 mm, 300 g



1 plain face, 1 convex face

COTTLE  
TS.16.41.19  
19 cm/ 7½"

The round face is used of the  
Cartilage crusher PAN-34.70



QUISLING  
TS.16.42.17  
17 cm/ 6¾"

Intranasal mallet

# INDEX

Diagnostic	1-4
Probes . Cotton Carriers, Suction Instruments	5-24
Scissors	25-58
Micro Scissors	59-63
Scalpel & Knives	64-75
Dressing & Tissue Forceps	76-102
Sponge Forceps	103-109
Hemostatic Forceps	110-134
Dissecting Forceps	135-144
Needle Holders	145-163
Bandage Instruments	164-167
Mallets	168-173
Intestinal & Tissue Grasping Forceps	174-202
Gyneoclogy	203-253
Obstetrics	254-268
Bandage & Plaster Cast Instruments	269-273
Sterilization	274-277
Suture	278-286
Bone File, Elevators & Raspatories	287-312
Orthopedic Instruments(Bone Cutting Forceps, Bone Holding Forceps & Saws)	313-343
Orthopedic Instruments (Chisels & Gouges)	344-356
Orthopedic Instruments (Curettes)	357-366
Orthopedic Instruments (Bone Rongeurs)	367-377
Retractors	378-438
Self Retaining Retractors, Abdominal Retractors	439-478
Cardiovascular Instruments	479-505
Eye Instruments	506-523

# INDEX

Otology Instruments	524-588
Laryngoscopes	589-607
Dermatology Instruments	608-610
Holloware	611-618
Thoracic Instruments	619-626
Neurosurgery Instruements	627-653
Urology Instruments	654-663
Mouth & Throat Instruments	664-712
Nasal Instruments	713-772



Address: Rattian Syedan Sialkot Pakistab  
Sialkot 51050 Pakistan.  
Email: [itsurgicalinstruments@gmail.com](mailto:itsurgicalinstruments@gmail.com)  
Contact/Whatsapp: +92 3227444885  
Contact/Whatsapp: +92 3167153805